

DSIR AND FOC  
FIRE RESEARCH  
ORGANIZATION  
REFERENCE LIBRARY

No. A12.CD.47

# CIVIL DEFENCE

HANDBOOK No. 7

## Rescue



PUBLISHED FOR THE HOME OFFICE  
AND SCOTTISH HOME DEPARTMENT BY  
HER MAJESTY'S STATIONERY OFFICE

PRICE 7s. 6d. NET

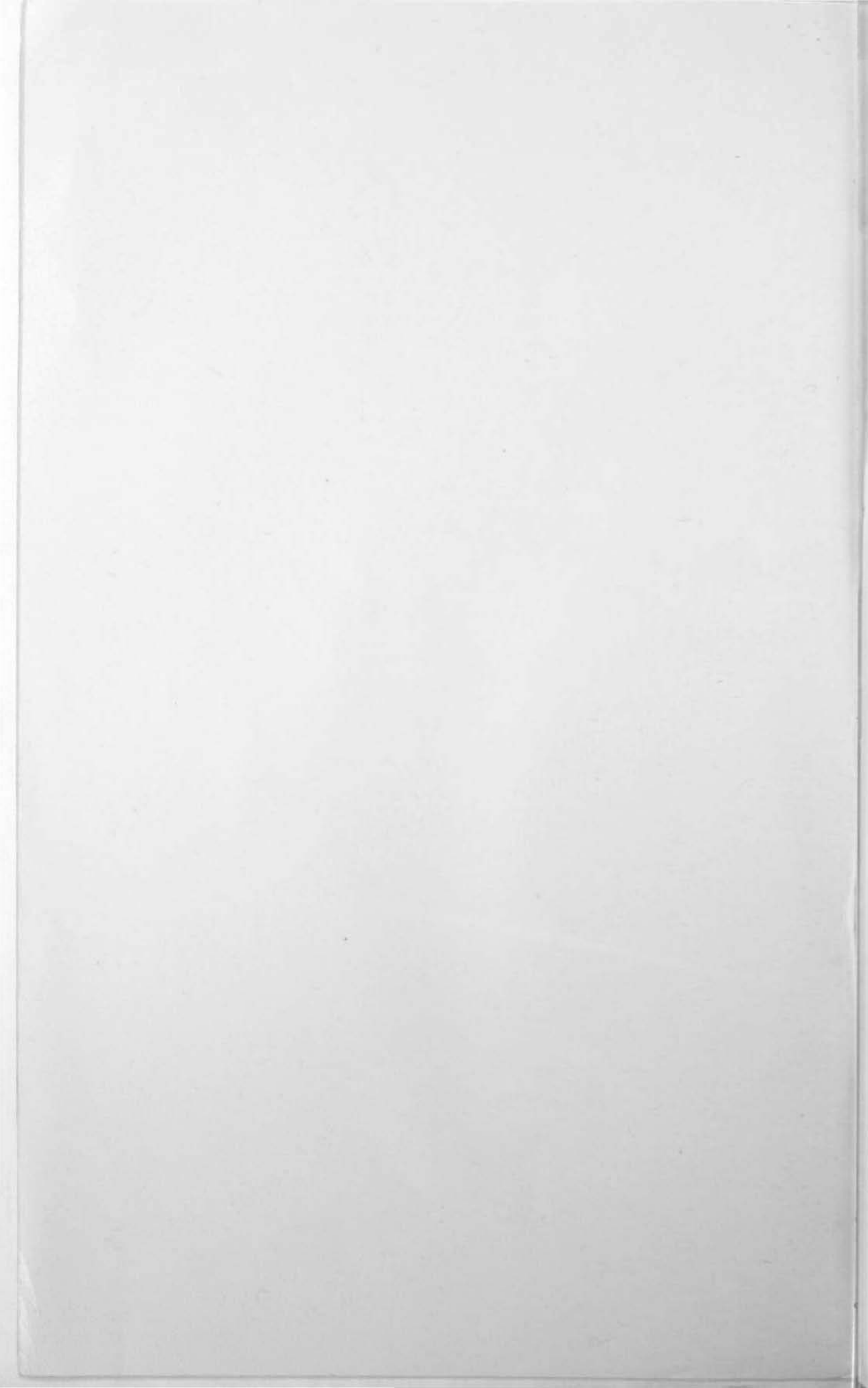

HOME OFFICE  
SCOTTISH HOME DEPARTMENT

CIVIL DEFENCE HANDBOOK No. 7

# Rescue

*This Handbook is a revised edition of,  
and replaces, the  
Civil Defence Rescue Manual*

LONDON  
HER MAJESTY'S STATIONERY OFFICE  
1960



## Preface

- 1 In this handbook, which is a revised edition of the Rescue Manual, no changes have been made in the principles of rescue techniques.
- 2 Since the Manual was issued, however, manpack equipment has been supplied to the Rescue Section of the Civil Defence Corps, and details of this and the method of its use are given in the handbook. Similarly, new items of hauling and lifting equipment and hydraulic power equipment have been introduced; their use and maintenance are explained in chapters under these headings.
- 3 Emphasis is placed on improvisation methods, and the need for using materials found on the site in conjunction with items of equipment carried in the manpack and by hand.
- 4 There is an additional chapter on the responsibilities of officers, and some of the principles of man management are enunciated in this, as well as their duties in rescue operations after a nuclear attack. The chapter on party leaders' duties and responsibilities has been brought up to date.
- 5 Since the Armed Forces will be aiding the civil power in any future war, tables showing the formation for civil defence duties of an Infantry Battalion and Regiments of the Royal Artillery are included in the appendices.

### Note for members of the Armed Forces

In the text of this handbook all references to ranks and units relate to the Rescue Section of the Civil Defence Corps, and these should be amended where necessary to correspond with particular formations of the Armed Forces e.g. read Rescue Sections for rescue parties and Rescue Section Commander for rescue party leader. (See also Appendix D and Civil Defence Pocket Book No. 2 "Military Support in Civil Defence").



# Contents

<i>Chapter</i>		<i>Page</i>
<b>Part I. General</b>		
1	Organisation and functions of the Rescue Section . . . . .	1
2	Duties and responsibilities of officers . . . . .	3
3	Duties and responsibilities of party leaders . . . . .	7
4	First aid in rescue operations . . . . .	12
5	Personal, party and platoon manpack equipment . . . . .	14
6	Types of damage from modern air attack . . . . .	16
7	Damage to public services . . . . .	24
<b>Part II. Rescue techniques</b>		
8	The elements of building construction . . . . .	28
9	Manpack equipment—Improvisation . . . . .	41
10	Some uses of the wire bond. . . . .	44
11	Casualty handling in rescue operations—normal methods . . . . .	50
12	Casualty handling in rescue operations—improvised methods . . . . .	70
13	Fibre ropes . . . . .	86
14	Knots and lashings . . . . .	91
15	Principles of levering and jacking. . . . .	100
16	Propping, strutting and improvised supports . . . . .	103
17	Ladders for rescue work—short extension ladder . . . . .	108
18	Rescue from basements . . . . .	112
19	Rescue by debris clearance . . . . .	117
20	Access to voids; linking of voids; the debris crawlway . . . . .	120
21	Pickets and holdfasts . . . . .	126
22	Improvised derricks and sheer legs . . . . .	135
23	Rescue from heights . . . . .	143
24	Hauling and lifting equipment . . . . .	152
25	Hydraulic power equipment . . . . .	162
26	Temporary shoring . . . . .	175
27	Steel wire ropes . . . . .	185
28	Slings . . . . .	187
29	Portable floodlighting. . . . .	190
30	Flame cutting . . . . .	192
<b>Part III. Operations</b>		
31	Briefing . . . . .	206
32	The rescue plan—stages of rescue . . . . .	211

**Part IV. Miscellaneous**

33	Recovery of valuables . . . . .	220
34	Procedure in regard to the dead . . . . .	221
35	Carrying heavy loads . . . . .	222

**Part V. Training**

36	General principles and organisation of training . . . . .	225
37	Refresher training . . . . .	229

**Appendices**

A	Organisation of the Rescue Section . . . . .	233
B	Rescue Section equipment	
	I Party . . . . .	234
	II Platoon . . . . .	235
	III Company . . . . .	236
C	Assembly, stowage and carriage of personal, party and platoon manpack rescue equipment . . . . .	238
D	Territorial Army units—rescue and casualty evacuation role . . . . .	245
E	Briefing of commanders of supporting troops . . . . .	248
F	Example of briefing of Platoon Rescue officers at Sector, Post Warden and Senior Warden level . . . . .	250
G	Example of verbal orders by Platoon Rescue Officer . . . . .	254
H	Suggestions for training in briefing . . . . .	256
J	Refresher exercises . . . . .	257
K	Estimating loads . . . . .	259
L	The pul-lift . . . . .	260



# PART I GENERAL

## CHAPTER 1

### Organisation and Functions of the Rescue Section

**1.1** The Rescue Section is one of the five sections of the Civil Defence Corps. The functions of the Rescue Section are:

- (a) to save life by rapid extrication of persons trapped beneath debris or in buildings damaged by enemy action;
- (b) to render first aid to such trapped persons or persons so released and to send them for further treatment.

Secondary functions, once immediate life-saving tasks have been completed, may include:

- (c) taking such steps as may be necessary for the temporary support or demolition of damaged structures where collapse may endanger life or obstruct essential traffic or hinder the work of the section itself or of other civil defence and associated services;
- (d) supporting specialist debris clearance parties operating with mechanical plant to allow further penetration of vehicles;
- (e) the recovery of the dead; this may not be solely the responsibility of the Rescue Section, but it will have to be considered in the light of priority requirements at the time.

In addition to these primary and secondary functions, the Rescue Section may be called upon to do any work falling within the definition of civil defence duties.

**1.2** First aid is an important responsibility of the Rescue Section but it must always be remembered that the section is primarily concerned with those casualties who are trapped in damaged buildings or debris. The Ambulance and Casualty Collecting Section has the primary responsibility for first aid and for organising the carrying of stretcher cases to ambulance loading points. (In Scotland, where there is no Ambulance and Casualty Collecting Section of the Civil Defence Corps, these duties will be undertaken by casualty wardens and casualty collecting wardens who form part of the Warden Section in Scotland.)

**1.3** The Rescue Section is essentially a mobile force, and in the main rescue operations must be carried out with tools that can be taken over debris by the rescue personnel themselves. The section has been organised with these considerations in mind.

## Organisation of the section

- 1.4** The basic unit of the Rescue Section is the rescue party of eight men, including the leader and deputy leader, equipped with manpacks to enable essential tools to be carried conveniently over debris. Six such parties constitute a rescue platoon commanded by a Rescue Officer and a Deputy Rescue Officer. Five of the parties will carry the standard "party equipment" (see Appendix B (I)) which will suffice to enable all six to get to work. The sixth party will carry "platoon equipment" (see Appendix B (II)) which will provide an immediate reserve and more specialised items of equipment. The allocation of platoon equipment to the sixth party is simply for its convenient carriage over debris; training in the use of the specialised equipment forms part of the advanced training for members of the Rescue Section.
- 1.5** Each platoon will be equipped (in war) with three personnel carrying vehicles (P.C.V.), two parties riding in one vehicle, together with a staff car for the Rescue Officer and his Deputy; drivers for the three personnel carrying vehicles and the staff car will be additional to the platoon complement of parties. All party and platoon equipment will be carried in personnel carrying vehicles.
- 1.6** Three platoons will form a Rescue Company, commanded by a Company Rescue Officer and a Deputy Company Rescue Officer. Heavier equipment which cannot be carried by rescue parties, items only required in special circumstances (e.g. flame cutting outfits and floodlights), and reserve stores (see Appendix B (III)) will be allotted on a Company basis to be brought forward as required in Company Equipment Vehicles (C.E.V.). Three motor cycle dispatch riders will be attached to each company and the Company Rescue Officer and his Deputy will be provided with a staff car.
- 1.7** Three companies will form a Rescue Column under the command of a Column Rescue Officer who will be provided with a staff car, and three motor cycle dispatch riders will be attached to each column.
- 1.8.** The organisation of the section is summarised in Appendices A and B.

## CHAPTER 2

### Duties and Responsibilities of Officers

- 2.1 The senior appointments in the Rescue Section are those of Head of the Rescue Section and Chief Rescue Officer.

#### The Head of the Rescue Section

- 2.2 The Head of the Rescue Section is an appropriate permanent officer of the Corps authority (e.g. the County Surveyor or the Borough Engineer) who is appointed by the Corps authority to have charge of the Rescue Section, and be responsible to the authority for its organisation and training. This officer is not by virtue of his position as Head of the Section a member of the Corps. In peace, the Head of the Rescue Section is the Corps authority adviser on all rescue matters, and in war it is to be expected that he would be on duty in this capacity at the senior level of control with which his Corps authority is concerned.

#### The Chief Rescue Officer

- 2.3 The Chief Rescue Officer is the senior ranking member of the section. He is primarily a field commander, responsible for the supervision of rescue operations undertaken by his section. In addition to his technical knowledge of rescue work he is responsible for the efficiency of his officers and, in operations, for their relief and replacement as necessary; he would also be responsible for the technical efficiency of rescue operations, for the relief of his forces and generally for their effective employment in accordance with the Controller's plans. He would work from some appropriate level of control (which need not be one with which his Corps authority is directly concerned), not as part of the control staff, but as the officer commanding from a place where he can be in touch with the Controller and receive as full intelligence as is available. In peace, the Chief Rescue Officer is the principal aide to the Head of the Section.

#### Column, Company and Platoon officers

- 2.4 Officers of appropriate rank have been created to take charge of units of the Rescue Section. In war, their place would ordinarily be with the men they command, whether in operational bases or depots or in the field.

#### Qualities required in a Rescue Section Officer

- 2.5 The three qualities which a successful Rescue Section officer must possess are intelligence, the ability to lead and a knowledge of rescue techniques.
- 2.6 He must be able to see clearly the few essential to the success of a rescue operation, he must have the courage not to be side-tracked from his main purpose in the task confronting him, and his judgment must always be well-balanced.

- 2.7 To lead men, the officer must make a close study of human nature, for that is the raw material with which a commander has to achieve his end. The personal relationship between a leader and his men is, and always has been, one of the most potent single factors making for success. A commander must have the complete confidence and trust of his men if he is to succeed. Field Marshal Viscount Montgomery of Alamein has suggested that leadership is the 'will to dominate, together with the character which inspires confidence, and that the measure of a man's ability to lead is two-fold. First it lies in his will to dominate the men and events which surround him, the will to drive himself and his men to the limit of their power for a specific purpose, and the refusal to allow anything to divert him from his aim'.
- 2.8 The officer must realise that the rescue of trapped persons from damaged buildings involves its own particular technique requiring careful study and a considerable amount of thought in its application. Although knowledge and experience of building and of engineering works provide a useful background, this experience must be combined with considerable further education in rescue techniques before the responsibilities of an officer of the Rescue Section can be efficiently undertaken.
- 2.9 Every member of the section—officers, leaders and men—must be trained and organised so that they will be capable of maximum operational efficiency. Technical efficiency in the Rescue Section means one thing only—the degree of speed and efficient care with which rescue parties can recover trapped persons. Whatever other duties may fall upon the Rescue Section, this is the criterion by which its efficiency must always be measured.

#### **Responsibilities of Rescue Section Officers**

##### *Hazard from radioactive fall-out*

- 2.10 An important factor to be considered in rescue operations after a nuclear attack is the hazard from radioactive fall-out which may affect the carrying out of the task. Information as to the intensity of residual radioactivity in the area of operations may of necessity be limited; in war, every rescue officer would be equipped with an individual dosimeter and there would be one dosimeter for every two men. It would be the responsibility of rescue officers to see that members of the section did not use up unnecessarily their radiological lives, and that they were withdrawn if they reached the war-time emergency dose. Where exceptionally it became necessary to complete a task already in hand and no relief was available, unit commanders would have discretion to exceed the war-time emergency dose of any of the forces under their control up to a certain maximum. (See Civil Defence Training Memorandum No. 3 or, for Scotland, Civil Defence General Training Bulletin, No. 5.) They will need to keep in close touch with the Warden Section in order that they may be kept as up-to-date as possible with the radiological situation.

##### *Operational orders*

- 2.11 In tackling any rescue task an officer must know very clearly what he wants himself; he must see his objective clearly and must let everyone

else know what he wants, and what are the basic fundamentals of his rescue plan. He must at all times give firm guidance and a clear lead. Examples of the briefing a rescue officer might receive and of the orders he might give are contained in Appendices F and G respectively.

- 2.12** Having made known his plan, and issued his order to put this into operation, he must place complete trust in his subordinates and must give them freedom to carry out their part within the framework of his plan. He must trust them to use their own initiative on matters of detail.

#### *Importance of morale*

- 2.13** If the unit under the officer's command is to be successful in its work, the morale of the men must be maintained. A high morale is based on discipline, self-respect and the confidence of the men in their commanders. There is no book of rules which will help a commander to gain the complete trust and confidence of his men. Each commander will adopt his own methods and the ones best suited to his own personality. He will ensure that he is personally known to those under his command, thus helping to build up the team-work of his unit which is so necessary to success. There must be no seeking of popularity or relaxing of discipline—both are fatal and quite unnecessary—but the officer must be efficient at his job. Unless he is efficient his men will not have confidence in him nor respect him. Whenever possible the reasons for particular orders should be explained to the men.

#### *Relationship with party leaders*

- 2.14** It is important that there should be a proper relationship between junior officers of the Rescue Section and their party leaders. The party leader is the man who should not only see to the carrying out of his commander's orders, and his wishes, but should also act as a kind of interpreter between the officer and his men. Being nearer to the men than his officer, he is able both to tell the men about him and to tell the officer about his men. The value of a good and loyal party leader is beyond price and a platoon officer should do all he can to foster and deserve the loyalty of his party leaders.

#### *Personal example*

- 2.15** Officers and rescue party leaders should at all times conduct themselves in such a way as to be an example to their men. This is especially important in rescue work which usually requires considerable self-confidence and personal courage on the part of officers, leaders and men. By his coolness and perseverance in circumstances of difficulty and danger, an officer or leader can do much to give heart and courage to his men. An officer or leader who is easily demoralised, or who is unable to cope adequately with the task in hand, is a source of weakness to the section even though his technical knowledge may be sound and extensive. Officers and leaders must set an example of courage, fortitude and resolution, and so promote and maintain among their men an atmosphere of enthusiasm, initiative and loyalty.

### *Choice of party leaders*

**2.16** In action the rescue party leader has to make vital decisions which may affect the lives of many persons, and it is most important that these decisions should be carried out immediately. In all exercises and practices, therefore, officers must ensure that the men are trained to take their instruction directly from the leader, and everything possible should be done to strengthen his position with his own party. A great deal can be done to improve the standing of leaders by allowing them to attend periodical meetings held by the Chief Rescue Officer or other senior officer for the purpose of general discussion. This increases the leader's sense of responsibility, and gives him a regular opportunity of putting forward directly to his officers any suggestions or complaints that he may have to make.

**2.17** Suitable leaders can only be obtained by careful selection. No considerations other than a man's ability in action and his soundness of judgment should be allowed to influence selection. Officers should watch for these points and note carefully the qualities displayed by their men during training and when engaged in actual operations. Similar care should be exercised in selecting deputy leaders as they may, at any time, be required to take charge of a party.

### *Training of rescue parties*

**2.18** The work that has to be undertaken by members of the Rescue Section is often difficult and sometimes dangerous. It must be carried out with care and knowledge developed by thorough and adequate training, combined with practical experience gained at actual rescue operations or at exercises designed to simulate real working conditions. It is imperative that officers ensure that their instructors make use of every opportunity for adding to and improving the practical knowledge of rescue techniques of the men they teach, and that the party leaders have full scope for handling their parties.

## CHAPTER 3

### Duties and Responsibilities of Party Leaders

- 3.1** The leader of a rescue party occupies a position of responsibility both in the depot and in operations. In many ways he is a key man, being the direct link between the men themselves and their officers. In addition he is the one man who welds a collection of individual recruits into an effective party or team, capable of exerting a combined effort and where required. The magnitude of the rescue task in any future war has increased the importance of the party leader and made him more than ever one of the most vital links in the rescue chain. Although he will have a strong and recognised command above him and one to which he can always turn for advice or assistance, it will be on the excellence of his reconnaissance and the soundness of his initial plan of action that the overall success of the platoon or company will be built up. Rescue party leaders did a magnificent job in World War II; in any future operations they will have to think and work even more quickly, and no time must be lost by mistakes or haphazard approach to a task.
- 3.2** It is the leader's duty to ensure that the instructions of his superior officer are faithfully carried out by himself and his men; to make decisions in the absence of his superior; to organise his work and to train and direct his men so that their duties are carried out smoothly and effectively; to be continually on the watch for means of adding to the efficiency and preparedness of his team; to foster the loyalty of his men, both to himself and to those in authority; to earn their confidence in him and his leadership; and generally to control them efficiently and effectively.
- 3.3** The leader can best do this by encouragement and by example, by teaching his men to co-operate as a team and carry out their duties in a spirit of keenness and willingness. To win the confidence of his team, the leader must be quite clear in his mind what he wants done, how he wants it done, and the reason why it is to be done at all. He should take an impartial interest in each of his men, try to realise their individual capabilities and be watchful for their general welfare in the widest sense. His constant aim should be to build up a tradition and pride of service. While the chief officers and their staff are continually working to further the interest and improve the well-being of the personnel, the men owe it to themselves to assist in every way and it is the leader's duty to teach and encourage them to co-operate with those in authority and to give of their best.

#### **Personal qualities and practical ability**

- 3.4** Among the important personal qualities required in a leader are ability to appreciate a situation quickly and accurately, technical reliability, perseverance, careful attention to detail and ability to co-ordinate the work of his men.

- 3.5 *Ability to appreciate a situation quickly and accurately.* After being given his initial briefing and priorities by the Senior Warden, the first thing a leader must do is to make a rapid summing up of the situation. He must be able quickly to assess the nature of the problem and to decide the way in which he will tackle it. Priorities must be assessed, additional information obtained, and any other appropriate action taken to enable the job to be tackled not only expeditiously, but on the right lines. To do this the leader must be able to bring to bear all his knowledge and experience, and remain unflustered by the situation. Once his men have been deployed he must make a quick reconnaissance.
- 3.6 Whenever a party leader is in doubt about the way a particular rescue task should be carried out, he must not hesitate to seek advice from his senior officer. Incorrect approach to a task can mean many hours of fruitless work.
- 3.7 *Technical reliability* means sound knowledge of rescue work in its widest sense; methodical and thoughtful preparation for the task in hand; orderly carrying out of the successive stages of rescue; and careful recording of what has been done. The leader's knowledge of his work can be gained only by a proper study of the subject and by the continual exchange of ideas with other leaders. He should lose no opportunity of discussing with other leaders how particular rescue jobs were tackled, what difficulties had to be faced, and how they were overcome. It may be claimed that no two rescue jobs are the same, and that it is of little value to study what has been done at other tasks. Experience shows this to be wrong. Though no two jobs are exactly the same, the general procedure and methods of "attack" have many features in common. Men who have the important responsibility of saving life can usefully spend time in examining and discussing tasks and in exchanging experiences. Just as good leadership is the key to successful rescue operations, so sound knowledge—the basis of self-confidence—is the key to good leadership. It broadens the leader's outlook and teaches him not to be resentful of constructive criticism, but to welcome it as a corrective and as a stepping-stone to perfection.
- 3.8 *Perseverance* enables the leader to complete his tasks in spite of setbacks and difficulties. It also teaches him self-discipline.
- 3.9 *Attention to detail* is important as the basis of sound and effective rescue work. Neglect of detail creates slovenliness of mind and habit, breeds accidents and lowers the performance, morale, and prestige of the section. *Quality of work is much more difficult to achieve than quantity or speed.* It requires a much greater personal effort; but it is far more effective and productive of useful results. Reasonable speed is a necessary consideration in every operation, but speed without quality is of little value, and may be dangerous, though spectacular to the lay on-looker. Leaders must teach their men that the efficiency of their work is a primary consideration, that speed must be regulated according to the purpose in hand and with due regard to the safety not only of persons trapped but also of the personnel.



**3.10 Co-ordination.** Effective co-ordination ensures that the leader and all his men work unitedly as a team towards the common end. Every man must work harmoniously with his fellows so as to achieve the desired result in the quickest, safest and least tiring manner. The leader's most important duty is to achieve this co-ordination; and in most circumstances, he will be far more effectively employed in co-ordinating the work of his men than in attempting to do the work himself.

**3.11** As the leader is a practical man, he may find it difficult to resist the temptation to take a hand in the work, especially when life is at stake. Experience shows, however, that *when the leader himself takes too great a part in the manual work, the general efficiency of the operation suffers* and the men tend to work as individuals and not as a team. Except in rare instances, the effect is not to accelerate but to delay the ultimate release of trapped casualties. Thus, cases have occurred where in the absence of proper reconnaissance and supervision by the leader, men have worked for hours extricating a casualty whilst several others less badly trapped were neglected during this period. In other cases, through faulty directions, men have spent precious time laboriously piling debris higher still over the place wherein casualties were trapped. The leader's task is to retain a grasp of the situation and to maintain effective control until rescue work is completed. He must keep all his men fully employed and ensure that, while lives are at stake, no worker stands idly about waiting to be told what to do next.

#### **Party discipline**

**3.12** Every leader is responsible for the good conduct and behaviour of his men, and must have the courage to see that his instructions are obeyed. The leader's understanding of his men must be increased by frequent exercises. Such exercises give the leader an opportunity to develop the art of giving commands in a clear and unmistakable manner, and what is even more important, of so asserting himself that his instructions are promptly and properly carried out. No opportunity should be lost by leaders at exercises of "trying themselves out" in this way. Experience shows that rescue party men generally prefer working under a leader who asserts himself; they are the first to realise that efficient control makes their work easier and relieves them from the strain of not knowing what to do.

**3.13** A good leader should be able to maintain a good standard of discipline and secure compliance with all reasonable instructions. Only in the last resort should he report cases of insubordination and other faults to his superior officer who, if unable to deal with the situation, must at once refer the matter to a higher authority. Leaders should not allow smoking during training sessions and exercises.

#### **Distribution of party: use of deputy leader: use of public**

**3.14** The division of a rescue party into smaller working units will depend largely on the priority of commitments, and the supplementing of his party members by the help of persons trained in light rescue or elemen-

tary rescue or by members of the untrained public. The early release of uninjured persons may be a prime consideration in providing a leader with supplementary labour.

- 3.15** The deputy leader will, therefore, frequently be given tasks using "rescue" trained and other personnel. To enable the deputy leader to undertake such work efficiently, it is essential that his training and qualities ensure a thorough knowledge of a leader's responsibilities.

#### **Co-operation with other services**

- 3.16** Party leaders must co-operate fully with other services working at the scene of operations, especially the Fire Service. If fire is present the whole of rescue operations will be guided in accordance with the fire fighting plan. Any requests for assistance from the Fire Service, such as turntable ladders or pumps, must be sent through officer-in-charge of civil defence operations—e.g. Post Warden or Senior Warden. If several parties are working together the request will go first to the senior Rescue Section officer. If the Fire Service ask for assistance, the party leader will work his party in accordance with the Fire Service request and directions.

#### **First aid and stretcher bearing**

- 3.17** The arrangements for casualty collection have not taken away the responsibility of the Rescue Section for administering first aid during rescue, and for stretcher bearing. Rescue parties are not intended to be stretcher bearing parties, though they may help in this work once rescue is completed. Short carries to casualty collecting points, or to cover in the event of fall-out, are of course part of the rescue operation. The party leader will ask for assistance from the Ambulance and Casualty Collecting Section (in Scotland, the Warden Section) to enable the Rescue Section to concentrate on rescue, but if this is not available, the work must be undertaken by the Rescue Section.

#### **Handing over and reliefs**

- 3.18** When a party which has been working for some time is relieved by a fresh party, it is essential that contact should be established between the incoming and outgoing leaders. The latter verbally informs the former of the plan of action and what work is in hand. It is preferable that the outgoing leader accompanies the incoming leader on the latter's initial reconnaissance. Equipment in position should not normally be removed by the outgoing party, but should form a basis of exchange or be left for recovery later.

#### **Welfare of party**

- 3.19** The leader must watch for signs of fatigue in his men. For their own sakes, and in the interest of the rescue effort, men must not be allowed to work until they are exhausted completely, but should be given periods of rest, or changed over from a heavy to a lighter task.

#### **Inventory of party equipment**

- 3.20** The party leader is responsible for all equipment issued to his party. At every change of shift the party leader must check this. This also applies

after work at an exercise or in rescue operations. He must report items that are lost, damaged or worn.

### **Knowledge of layout of local buildings**

**3.21** Rescue leaders should visit and examine the form of construction and general layout of as many typical buildings in their area as possible, taking particular note of points that may be of assistance if rescue operations in buildings of such types ever become necessary.

### **Procedure in regard to the dead**

**3.22** If no doctor is available, the Rescue party leader must take responsibility of confirming death in clear cases. Bodies must be labelled, and labels signed by the party leader or his deputy. (See chapter 34.)

### **Recovery of valuables**

**3.23** When valuables are recovered and handed to the party leader he will without delay arrange for them to be given to the Senior Warden or Post Warden or senior police officer on duty, a receipt being obtained. (See chapter 33.)

## CHAPTER 4

### First Aid in Rescue Operations

- 4.1** A primary function of the Rescue Section is the rendering of first aid to trapped casualties, and it follows, therefore, that every member of the Section must pay particular attention to his first aid training. It is of little use if skilled application of rescue techniques leading to the speedy location, approach and extrication of casualties is wasted by incorrect first aid treatment. Rescue men are not expected to be specialists in first aid, but they must be able to render first aid sufficient to meet the requirements of the casualties until they can be handed over to the specialist first aid parties of the Ambulance and Casualty Collecting Section (in Scotland, casualty wardens).
- 4.2** Rescue parties will have to deal with casualties found among the dirt and dust of badly damaged buildings, and at the same time contend with the possibility of further collapse of buildings. Both casualties and rescuers may be inconvenienced by smoke from smouldering fires. Once the casualty has been located, a decision has to be made as to whether there is any immediate danger to life—(i) to the casualty (a) is severe bleeding taking place? (b) is there any interference to normal breathing? (c.g. debris covering the face or causing pressure on the chest, or contact with a “live” electric wire), (2) to both casualty and rescuer, such as the dangerous condition of nearby masonry or an escape of coal gas. These immediate dangers must be dealt with at once. Bleeding must be controlled, interference to breathing removed, the source of danger removed, (in the case of probable further collapse of masonry something must be done to prevent this happening) or, the casualty must be removed from the danger.
- 4.3** The next question is to decide whether the casualty must be moved before any first aid is rendered. The rescuer should appreciate that:— (a) There should be as little movement as possible before an assessment of the casualty’s injuries can be made. The casualty may have a broken bone, and moving him before this is immobilised would cause pain, even if no further damage was caused to adjacent organs or arteries etc. (b) Severe bleeding itself is an “imminent danger” (loss of 2 pints of blood may constitute a grave danger to life).
- 4.4** It will be clear that ordinary commonsense allied to skill is required in giving first aid to casualties in the conditions in which rescue personnel will work. The rescuer called to attend to casualties must be able to determine a sequence of action suitable for each case. Certain general principles, however, apply to practically all cases:
- (1) Bleeding, if severe, must be treated at the earliest possible moment, no matter what other injuries are present, for if it is not stopped death may quickly ensue. Bleeding can usually be

stopped by the application of a pad and bandage or prepared dressing, with a second one over the first if necessary.

- (2) A quick but efficient appraisal should be made of the casualty's position as this will greatly help in determining where his injuries are.
- (3) A casualty must, however, be moved at once from any continuing or imminent danger which cannot be removed from him.
- (4) Normal breathing should be ensured, so far as is practicable; if required artificial respiration should be started and maintained.
- (5) Handling should be extremely gentle in cases where there is a wound in the abdomen.
- (6) Fractured bones and the affected parts must be immobilised by one of the simple methods taught; if at all possible this should be done before the casualty is moved.

Life may be saved by prompt action. Aggravation of the casualty's condition can be prevented by careful handling and by protection of wounds and immobilisation of broken bones.

**4.5 Shock.** In all cases where casualties are encountered in damaged buildings some form of shock will have been sustained by them. Even when there is severe injury the shock may present the greater risk to life. If conscious the casualty will be impressed, either for good or bad, by the demeanour of the rescuer. A feeling of "well-being" can be created by the obvious capability of the rescuer to alleviate a shock condition.

**4.6** A good diagnosis of the injury will be of the utmost value when deciding on the method of removing the casualty from the position in which he is found prior to the application of first aid and placing him on the stretcher for subsequent handing over to the Ambulance and Casualty Collecting Section (in Scotland, the Warden Section). Running through all practices and exercises must be the theme for the closest possible association and working partnership between the leaders of rescue and first aid parties, as will in fact be the case in all actual rescue operations in war. This chapter is written in general terms, allied to the chapters in this handbook dealing with casualty handling and to the specific instruction in Civil Defence Handbook No. 6 "First Aid".

## CHAPTER 5

# Personal, Party and Platoon Manpack Equipment

### Introduction

- 5.1 In World War II the degree of devastation was rarely sufficient to impede the passage of vehicles for any length of time although, on many occasions, one way traffic was the rule for considerable periods. Moreover the pattern of bombing was spread out into comparatively easily managed incidents rather than widespread damage over a large area.

### Approach

- 5.2 As far as approach to one of these incidents was concerned, it was only on very rare occasions that rescue vehicles could not get up to or very near to the task. Because of the widespread areas of damage likely to be caused by a nuclear explosion, vehicles may be stopped by debris a long way short of particular objectives. In such circumstances it is necessary for rescue tools and equipment to be carried forward on foot. The provision of manpacks will ensure that rescue personnel will be able to reach their objectives on foot with the tools necessary to carry out the average rescue task. The utmost use must be made of broad highways and open spaces, such as sports grounds, parks and gardens, railway cuttings, etc.

### Manpack equipment

- 5.3 The technique of rescue remains much the same whatever the cause or nature of the devastation and, in order to carry out this work, tools are necessary. Some tools must be carried forward by the members of the Rescue Section, and the selection of tools and equipment carried in the manpacks and by hand, in the hands of well trained and determined personnel, who also have a sound knowledge of the methods of improvisation with materials to be found on the site, should enable them to carry out a wide variety of tasks.

### Manpack factors

- 5.4 Manpack equipment must satisfy the following conditions:
- (a) It must not be too heavy or awkward for any individual to carry.
  - (b) It must, to a large extent, leave the hands free.
  - (c) It must consist of the minimum variety of tools to enable a trained man to carry out as many tasks as possible.
  - (d) It must include some first aid equipment. This is carried separately.
  - (e) All tools must be capable of being easily removed and checked.

### **Personal manpack and party equipment**

- 5.5 The equipment decided upon falls into two categories—personal manpack, i.e. carried by each individual, and party equipment, i.e. additional light equipment shared among members of the Rescue Party. The fitting and stowage of the various items is standardised and should be adhered to in all demonstrations and practices. Details of this equipment, and instructions for its assembly and fitting, are given in Appendix D.

### **Carrying forward specialised platoon manpack rescue equipment**

- 5.6 Much thought has been given to the provision of equipment in order to allow rescue personnel to carry out an even greater variety of tasks. In other words, specialised equipment must be to hand when the need is there. The number of items of equipment to be carried has been kept to the minimum by selecting equipment capable of performing more than one rescue task.
- 5.7 It has been decided that one party in six, i.e. one party in each Platoon, will carry forward certain items of rescue equipment. These items are sorted out into man loads and fitted into eight manpacks Mark I. The weight of each load varies from 35½ lbs. to 43 lbs. and it will be appreciated that the loads will need to be allocated according to the physical capabilities of the members of any particular party. It should, however, be appreciated that *all* Rescue Section personnel should be trained in the Standard and Advanced Rescue syllabuses and that, during operations, they are available for all work, regardless of what equipment they personally carry in. Details of this equipment and weights are to be found in Appendix D.
- 5.8 It is visualised that the party wearing the platoon manpacks will travel as one party with the rest of the platoon in passenger carrying vehicles. In one of the three p.c.vs. there will be one party wearing standard party manpacks, and one party wearing the platoon equipment manpacks. The party wearing the platoon manpacks will at the outset debus at the most forward vehicle unloading point and proceed with the platoon rescue officer to where he sets up his headquarters (alongside or adjacent to the Post Warden or Patrol Post, as the case may be) and will remain there with the platoon equipment, perhaps dealing temporarily with casualties in the immediate vicinity, until the platoon rescue officer, after briefing and making his own appreciation, decides how the platoon equipment is to be used. The use can, in the main, be quite flexible according to the circumstances—Packs 1 and 2 can be used in conjunction or separately; Packs 3 and 4 must always be used in conjunction; Packs 5 or 6 can be used quite separately on their own, or in conjunction, or, if necessary, with Packs 1 or 2, or with 3 and 4; Packs 7 and 8 quite separately, or in conjunction, or in support of any other packs, or individual items may be used in support of any member of the whole platoon.
- 5.9 Stretchers and additional first aid equipment have been omitted on the assumption that first aid parties of the Ambulance and Casualty Collecting Section (in Scotland, casualty wardens) will be operating in the vicinity of rescue parties.

## CHAPTER 6

# Types of Damage from Modern Air Attack

### General Characteristics

- 6.1 When a nuclear weapon explodes an immense amount of energy is released almost instantaneously and the contents are transformed into a rapidly expanding white hot ball of gas at a temperature as high as that on the sun. From this "fireball" a pulse of intense light and heat is radiated in all directions. The materials in the fireball are also a source of radioactivity in various forms. As the fireball expands and cools, a powerful blast wave develops. As it cools still further, it shoots upwards to a height of many thousands of feet, billowing out at the top to give the appearance of a huge mushroom or cauliflower on its stalk.
- 6.2 The three forms of energy released in the explosion, namely, light and heat, radioactivity, and blast, all produce effects in different ways and in different proportions according to the position of the explosion in relation to the surface underneath. This chapter, however, deals primarily with the damage caused to buildings by the blast effect.
- 6.3 With nuclear weapons (as opposed to high explosive weapons), blast pressure rather than "impulse" tends to be the criterion of damage. If the effective blast pressure exceeds the static strength of the structure, failure must be expected. If it is less, no failure can occur however long the duration of the blast. In fact, nuclear bomb blast is more like a strong wind than the sudden blow of high explosive blast, and many of the failures observed at Hiroshima and Nagasaki and in subsequent tests resemble closely the kind of damage that might be done to buildings by a hurricane.
- 6.4 The scarcity of suction damage from the nominal bombs in Japan was due to the high blast pressures produced and to the fact that these were three or four times as great as the blast suction. With all such large explosions, if a building does not fail from blast pressure it is unlikely to fail under the lower stresses in the suction phase.

### Effect of blast on structures

- 6.5 The type of damage which long duration blast (from nuclear weapons) causes to structures can possibly best be appreciated by considering the forces to which a simple building is subjected during the passage of a horizontal blast wave. When the blast "front" strikes the front wall it is reflected back, and the pressure in the wave front builds up to more than double the original pressure. However, this build-up only lasts for a very short time and is mainly important for large flat surfaces such as walls of big buildings. As the blast wave passes over the building, the sides, roof, and finally the rear wall are subjected to what is known as the



“side-on” pressure in the wave, but since they are side-on and not face-on there is no extra pressure due to reflection. At this stage the front, roof, sides and back of the building are all subjected to more or less the full blast pressure, and the principal tendency then is for the building as a whole to be crushed.

- 6.6 But the pressure at and behind the blast front is accompanied by the blast wind which, while it exerts additional pressure on the front wall, exerts a suction\* on the back (since it is sucking air away from the back wall and to some extent also from the sides and roof) which tends to cancel out the pressure in the blast wave itself. The net effect is a much enhanced pressure on the front of the building, and most of the direct blast damage is produced there with comparatively little elsewhere. The building as a whole tends to be pushed over away from the explosion.
- 6.7 The above relates only to a building with blank walls. If the blast gets inside through openings in the front wall, the pressure inside, acting upwards on the roof, is the full side-on blast pressure, whereas the pressure outside is the blast pressure less the wind suction. The net result is therefore that the roof tends to be forced violently upwards, a feature which was noted in Japan and has been observed in published photographs of American nuclear weapon trials, where houses have appeared to “explode” when struck by the blast wave.
- 6.8 The ability of a building to withstand the shock of the blast wave depends upon its strength, its shape, and the number of openings into the building which serve to relieve the pressure on the outside walls. The strongest structures are heavily framed steel and reinforced concrete buildings, while among the weakest are shed type industrial structures having light frames and long roof spans.
- 6.9 The resistance to blast of brick structures is poor, partly because of their low resilience and partly due to their weakness against pressure from inside, since a comparatively small outward movement of the walls causes the floors to collapse.
- 6.10 The floors of a dwelling house are not constructed to carry tons of wreckage and so, in due course, they may bend, or break across at the centre of the joists, crashing down to form the roof of two voids, or they may remain fixed on one side and fall or sag down at the other, the bulk of the debris falling to the lowest point. The over-loading of the ground floor may well lead to similar collapse into the basement.
- 6.11 When external walls are sucked outwards, the bulk of the debris falls into the garden or street. The floors and roof, with some of the internal walls, are deprived of support and collapse in a heap, separated only by the furniture and such portions of the walls as remain. There may be voids formed by the furniture supporting the collapsed floors. It is possible to crawl through them in comparative safety provided that such supports are not disturbed.

---

\*The occurrence of “wind” suction in the positive phase of the blast wave when it strikes any form of structure must not be confused with the suction in the negative phase of the blast wave, which is independent of the presence of any structure.

### *Effect on framed buildings*

6.12 Framed buildings stand up well to blast and unless there is complete collapse, the debris from walls is prevented by floors from collecting in one large heap in the basement. (The panel walls are, in fact, no "lighter" than domestic house walls, e.g. 9-in., or 11-in. brick.) In framed buildings, whether of reinforced concrete or steel frame construction, there are usually reinforced concrete slabs (e.g. in floor, roof and sometimes in walls) and these, in the form of debris, present special problems that can be dealt with only by the experience and equipment of the fully trained rescue parties. Blocks of flats, modern cinemas and theatres, hotels, and city offices embody the framed types of construction.



Fig. 1. At or near ground zero, buildings are collapsed on themselves: Hiroshima, 1945



Fig. 2. Scene near ground zero: Nagasaki, 1945



Fig. 3. With specially strong buildings, roofs are crushed or dished in, even while the walls remain standing : Hiroshima, 1945

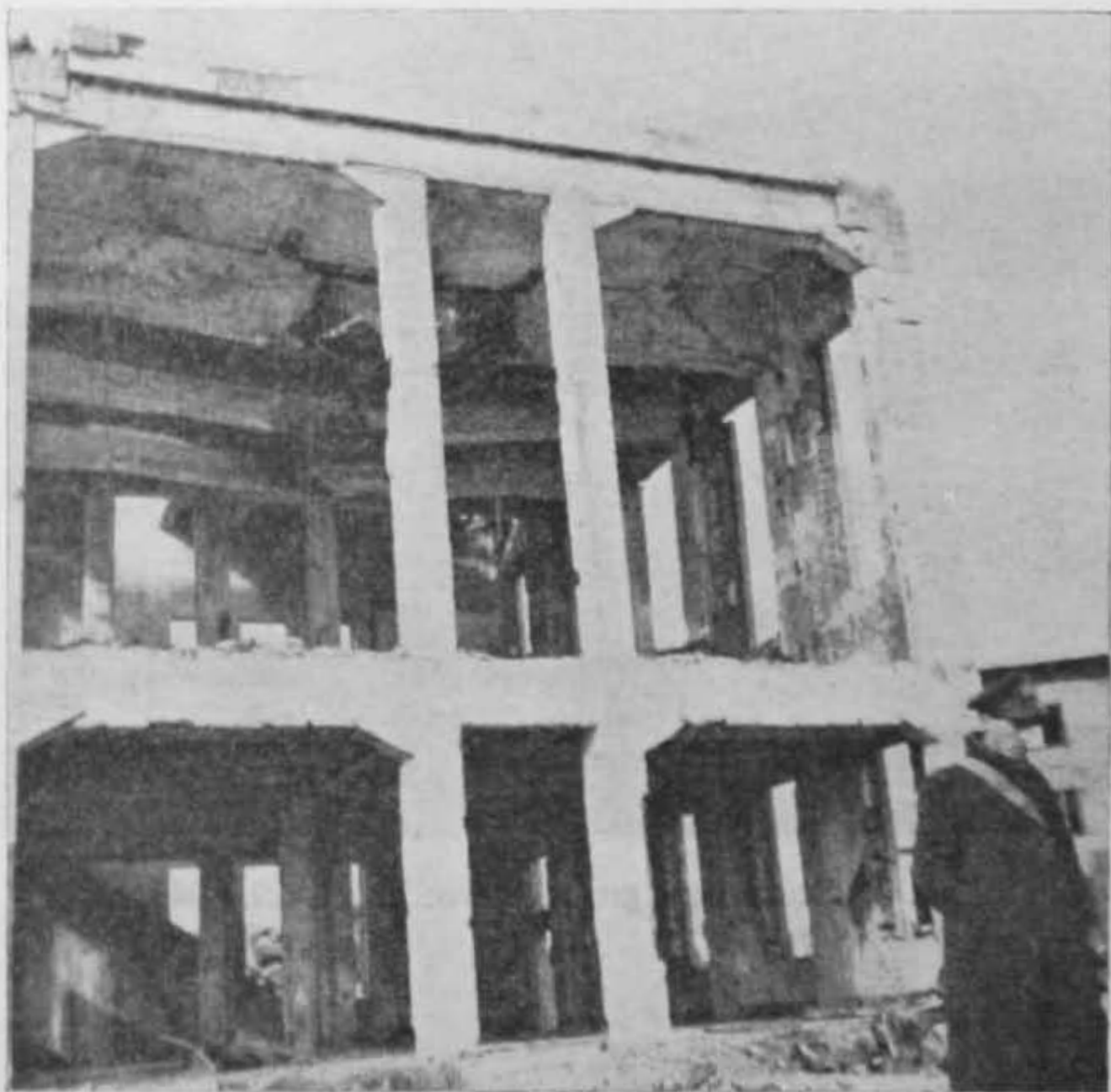

Fig. 4. Roofs are dished in by downward blast: Nagasaki, 1945



Fig. 5. Further away from ground zero, buildings are pushed over or distorted away from the explosion: Nagasaki, 1945

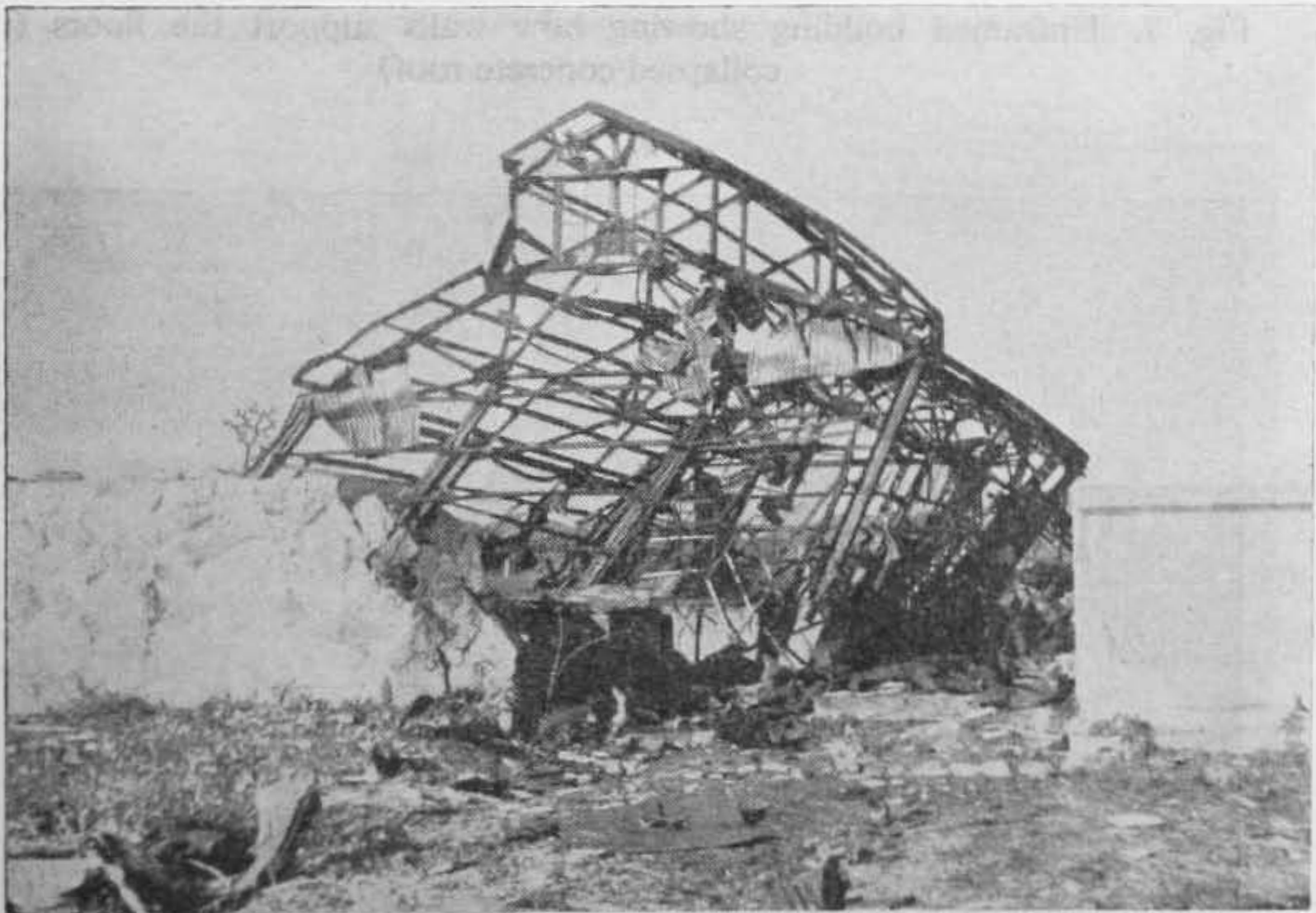
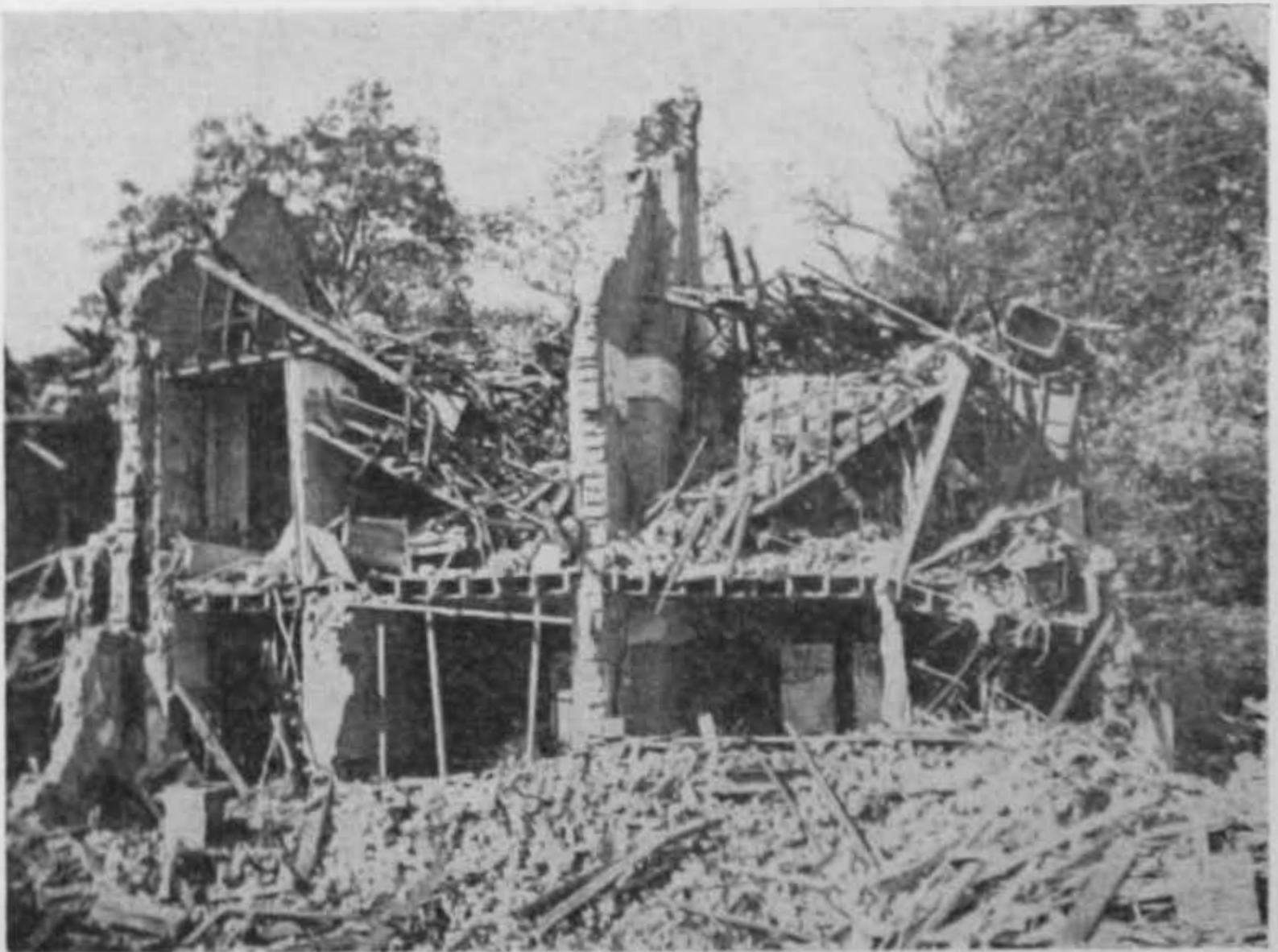

Fig. 6. Steel framed building distorted away from the explosion: Hiroshima, 1945



**Fig. 7. Unframed building showing how walls support the floors (note collapsed concrete roof)**



**Fig. 8. Effect of blast damage on unframed buildings**

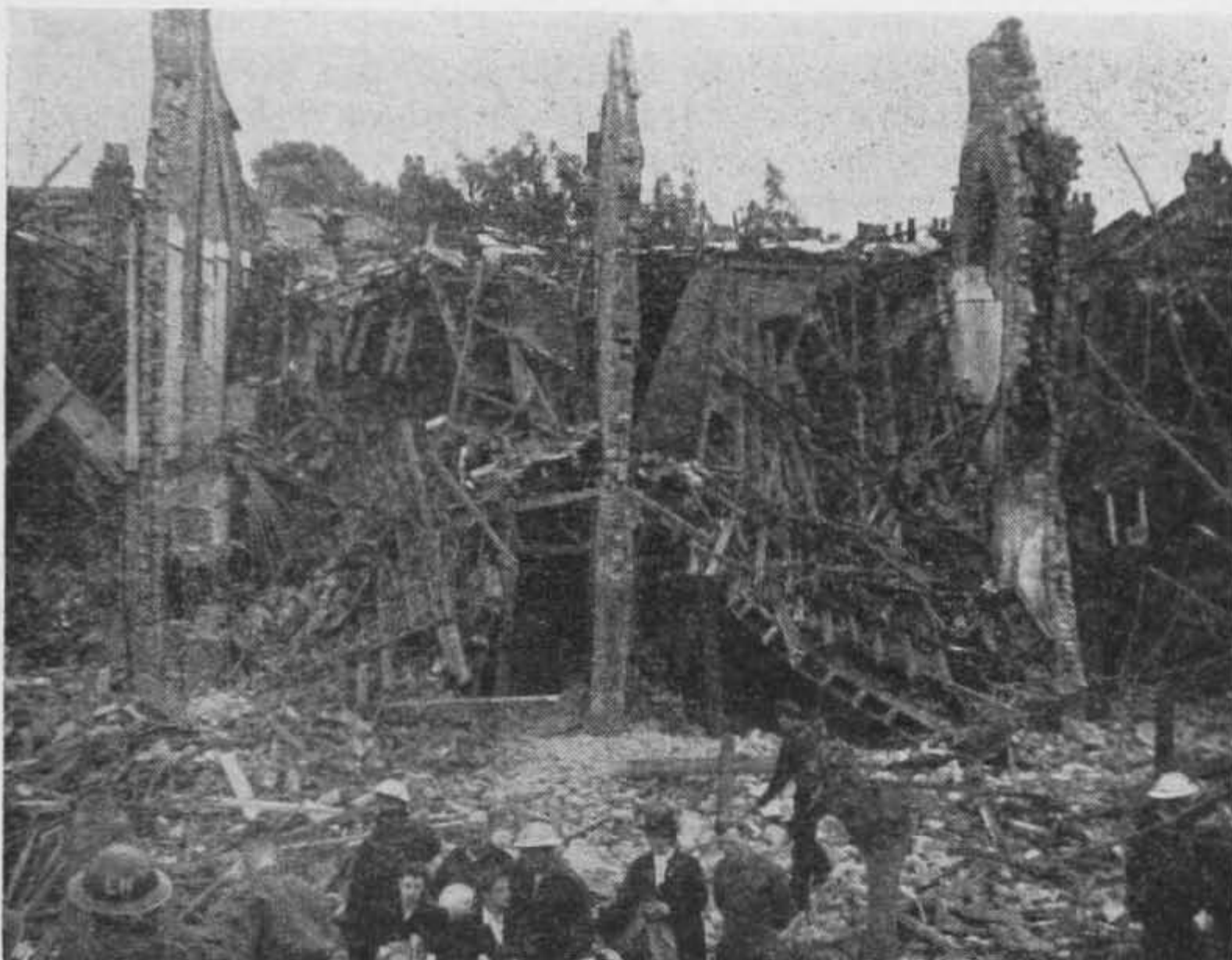

Fig. 9. Note how voids have been formed by the collapse of floors

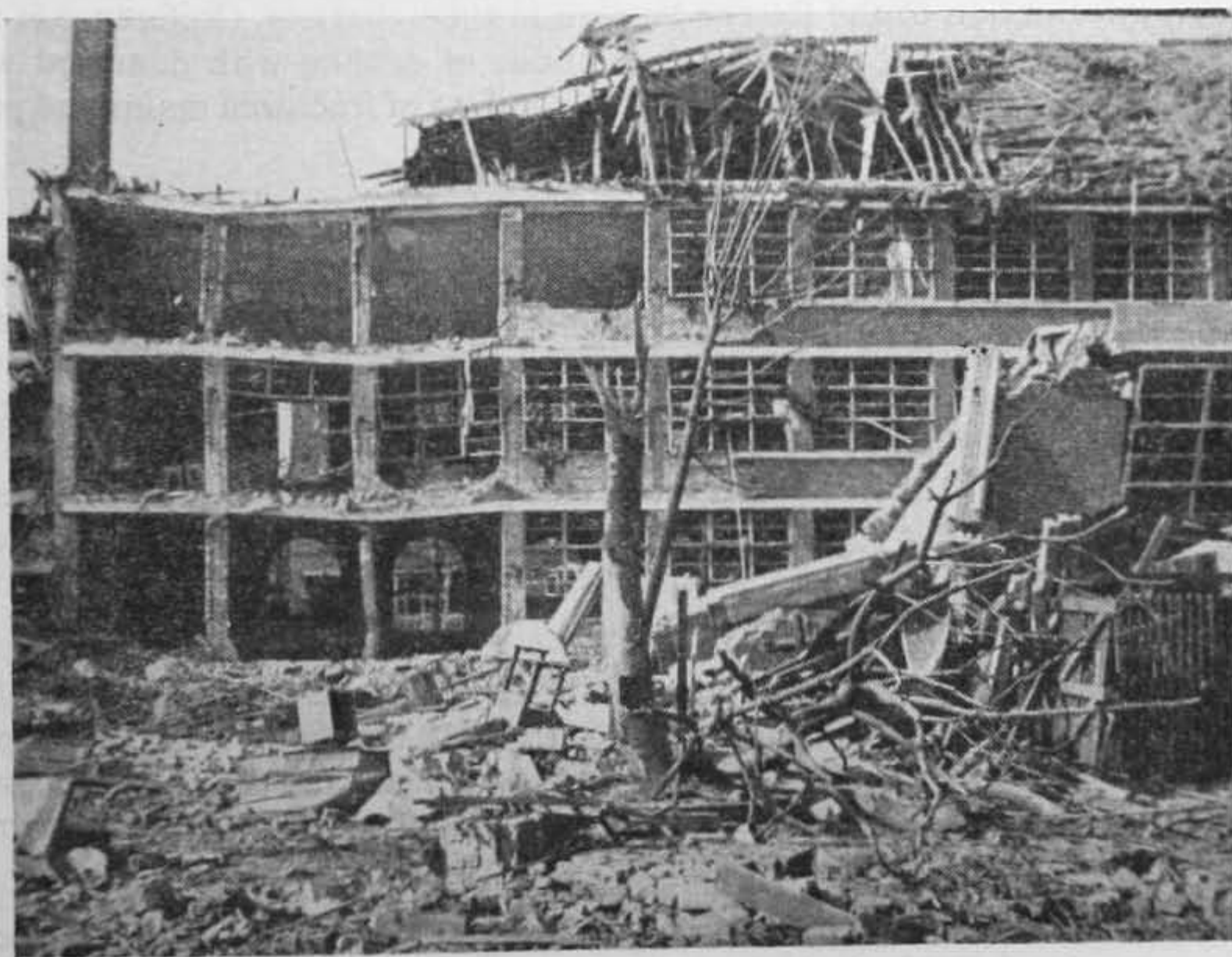

Fig. 10. Effects of blast damage on a framed building

## CHAPTER 7

### Damage to Public Services

- 7.1 Water, gas and electricity are supplied to almost all buildings and are liable, when damaged, to cause special complications and danger in rescue operations.
- 7.2 To deal with such problems and to ensure the rapid repair of these services, special repair parties will be formed from the employees of the public utility undertakings concerned, and will work in the closest co-operation with the civil defence organisation. During and after heavy attacks, however, these parties will have considerable work to do, and they may not be immediately available when required at a given spot. Rescue parties, therefore, must know sufficient about the service mains, supply pipes, and the like, to enable them to take any urgent measures necessary to minimise risk to life and to carry out their own work. At the same time they should realise that the consequences of cutting off a water main can be serious; for instance, it may deprive the Fire Service of water, and such measures should only be taken after consultation with a Post Warden or Senior Warden, as the case may be. The statutory undertakings concerned will assist by providing practical instruction and information to the Rescue Section in these matters. (Reference is made in Chapter 20 to emergency methods of dealing with damaged water, gas and electricity services, e.g., the sealing of fractured mains and pipes.)

#### Water

- 7.3 Water released from damaged or broken water pipes, or water accumulated as a result of fire fighting activities, may cause the flooding of part of a building below ground level, and the flooding, unless checked quickly, may endanger persons trapped in the basement. Where there is any risk of this happening the Fire Service should be asked through the Senior Warden either to pump out the water or to try to keep the level down until the trapped persons can be rescued. When the Fire Service is not available for this work, Rescue Officers and leaders should request the Senior Warden to send for any portable or other fire pumps there may be available in the district.
- 7.4 Unless a damaged building is well back from the road, it will usually be found that debris has buried the stopcock box containing the stopcock controlling the supply of water to the premises and made it inaccessible. It is, therefore, important to know where the stopcock box is normally situated and what other controls may be available.
- 7.5 If the stopcock can be found, flooding can be prevented or stopped by turning off this cock. It will usually be situated in the footpath at the front of the premises, just inside the boundary, or in a similar position at the rear of the premises. It may be in a small hole protected by an iron hinged cover appropriately marked or by a small square of stone.



7.6 Rescue personnel should be made acquainted with the form of surface box used by the water undertaking in their locality so that it can readily be recognised in any emergency. Some undertakings have adopted a special form of stopcock which can only be turned on and off by the use of a special key and bar. In these cases arrangements should be made locally for the rescue parties to be equipped with a suitable key for use in emergency.

7.7 In addition to the undertaking's stopcock there may often be found another stoptap on the service pipe close to the point where this pipe enters the building. In the same way this second stoptap controls the water supply to the whole building. If there is a storage cistern in the roof or top storey of the building, the supply pipe to this, usually known as the rising main, may also be separately controlled by a stoptap near the cistern. Services from the storage cistern to the various fittings or hot water supply may also be controlled by further stoptaps near the storage cistern. It should be the first object to control the water entering the building by turning off either the undertaking's stopcock or any stoptap on the rising main.

7.8 In some areas all supplies are taken direct from the main.

7.9 When water is running into basements from outside sources, such as damaged mains in the street, an attempt should be made to divert the flow either by constructing a rough dam with sandbags or other available material or by forming channels to convey the water away until the water undertaking can shut off the particular mains.

### Coal Gas

7.10 When a building is damaged, gas pipes are usually broken and there is consequently a considerable risk of escape of gas. Coal gas, being highly inflammable when mixed with air, will explode violently if ignited. **No lighted cigarettes or naked light of any kind must be taken near a damaged building until it is definitely known that there is no escape of coal gas.**

7.11 The presence of gas can generally be detected by the smell, but there is, of course, the possibility that the smell may be obscured by some other more powerful smell in the vicinity. It is important to remember that, in the event of damage to neighbouring underground gas mains, the gas may lose its characteristic smell in the act of filtering through surrounding soil, and dangerous concentrations of its deadly and odourless component (carbon monoxide) may be met in basements, cellars or shelters in the immediate neighbourhood of the damaged gas mains. It must also be remembered that the occurrence of an explosion does not necessarily mean that all the escaped or escaping gas has been burnt up.

7.12 The first effect of coal gas on human beings is to cause giddiness and loss of power in the limbs; further inhalation may cause unconsciousness and death.

7.13 As coal gas is lighter than air it does not remain highly concentrated for long except in enclosed places, and will normally disperse quickly as

soon as the escape is stopped. Whenever there is a smell of gas, the Senior Warden will initiate a request for the gas repair party to attend, but until they arrive an attempt should be made to locate and stop the escape of gas. As a first step, the tap controlling the main supply should be found, if possible, and the supply turned off. This tap is usually situated in the basement or the ground floor near the entrance or under the main stairs adjacent to the meter.

- 7.14 When the escape is on the supply side of the tap inside the building, a stopcock which sometimes exists in the road or footpath outside must be closed unless the point where the pipe is fractured can be located. Time should not be wasted in searching for this stopcock which may not exist; but the gas repair party should be summoned immediately.

### Electricity

- 7.15 In the great majority of bombed buildings, the electrical installation is so badly damaged that the main fuses are blown and the whole circuit rendered harmless. Care must always be taken, however, to avoid touching any cables, electrical tubing or fittings, until the supply has definitely been cut off or the installation is known to be dead.
- 7.16 Every installation is controlled by at least one main switch. When electricity is used for power as well as lighting, there may be two main switches, one for each supply. If there is more than one tenant in a building, there is sometimes a separate switch for each tenant. Main switches are placed as near as possible to the point where the supply cable enters the building. They are usually oblong or square iron boxes with an iron handle on one side. To switch off, this handle is pulled down. Usually the "on" and "off" positions are clearly marked on the box. Rubber gloves (or some other form of insulation, e.g. a dry blanket) should be worn on the hand when touching a switch, as the switch may be "alive" if it has received damage. It is an added safeguard to stand on a dry piece of timber before touching any electrical apparatus.
- 7.17 Even after the main switch has been turned off, the cable from the switch to the road outside will still be alive. This cable is easily identified as it is usually "armoured" about  $1\frac{1}{2}$  inches or more in thickness, or is laid in a cable box or trough.
- 7.18 If lamps within a building fail to light when the ordinary light switch is on, it should not be assumed that the current is cut off. Failure of the light may be due to broken filaments in the lamps or to blown fuses.
- 7.19 Fires caused by electric cables should be extinguished with dry sand or earth, not with water or fire extinguishers. Electrical cables, wires, switches and apparatus, should not be interfered with if coal gas is present; even the movement of a switch may cause a spark sufficient to ignite the gas.
- 7.20 Many factories and large buildings have their own transformer sub-station on the premises. This is usually in the basement and its entrance is always marked by a special "Danger" notice. These sub-stations, as well as any other electrical plant, motors, switchgear, and overhead

cables, should not be touched until some authorised person has rendered them harmless. The advice of amateurs who think they know all about electrical plant may be very dangerous and should not be relied upon.

### **Ammonia Fumes**

- 7.21** Many refrigeration plants contain ammonia, and when damaged, liberate this gas in large quantities. Ammonia has a very strong smell and is therefore easily detected. Some slight temporary protection from this gas is given by the Civilian Duty respirator, (or, in the case of the Armed Services, the General Service type of respirator) which, if used for this purpose, must have the container changed as soon as possible afterwards. Alternatively, a damp cloth placed over the nose and mouth gives reasonable temporary protection.
- 7.22** Certain other types of refrigerator employ refrigerants other than ammonia against which the above methods of protection are of no avail. In such cases an approach must be made through the Senior Warden for the services of members of the Fire Service with oxygen breathing apparatus.
- 7.23** Damaged refrigeration plants should always be approached from the upwind side.

between). The two sections are tied together with twisted metal strips or wire built into joints at intervals, the twist being necessary to prevent water running from the outside skin to the inner skin. Houses of three storcsys will, of course, have thicker walls and may be 13½-inch solid brickwork.

- 8.6** Partitions or division walls are the walls built inside the building to divide up into rooms the area confined by the outer walls. These partitions may also carry loads and may be constructed of 4½-inch brickwork, stone or timber framing with lath and plaster, or of breeze or other types of light-weight blocks. When they are load bearing they will usually rise from their own foundation and be continued vertically to the height required. Unloaded partitions on upper floors will not necessarily be placed directly above those on the floor below.

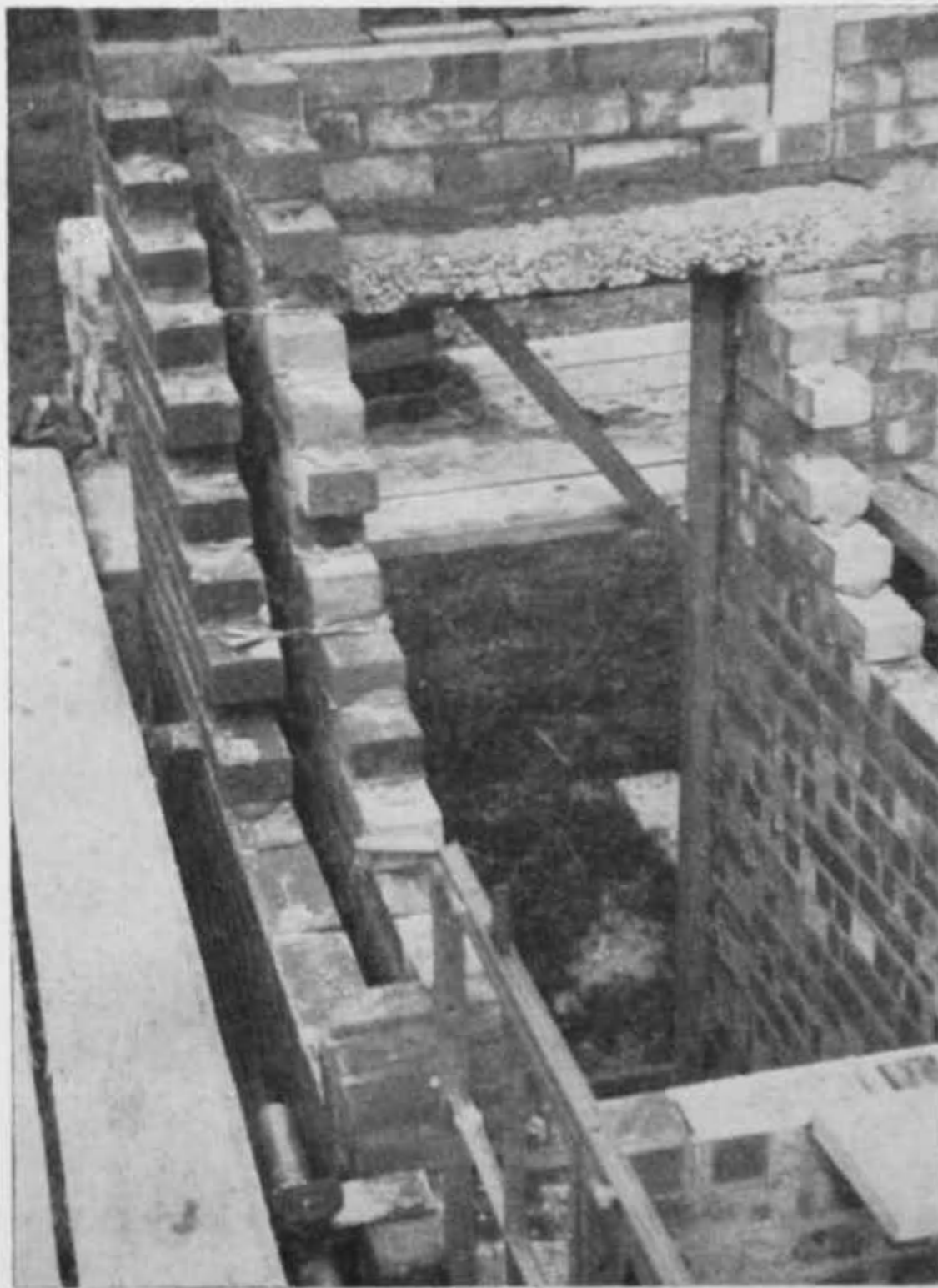

**Fig. 12.** Hollow wall construction

- 8.7** Openings in walls are formed as the wall proceeds, having arches or concrete and steel rod lintels built over the top to form a bridge or beam to carry the wall above. On external walls a sill or threshold, shaped and grooved to throw off water, is built in at the bottom of the opening. The frames of the windows and doors are usually built in as the wall is

erected and have metal straps or lugs attached to them for fixing, or they may have projecting ends for building into the wall to hold them in position.

- 8.8 *Damp proof courses.* Damp can penetrate a building from the ground on which it stands by rising up the walls, or rain may percolate through the walls or roof. This is most undesirable both from the point of view of health and also from the stability standpoint since dampness can set up rot in timber, rust steel, and decay brickwork, and so destroy the strength and stability of the building.
- 8.9 In view of these possible troubles, precautions are taken by covering the ground under the ground floors with a layer of surface concrete and leaving an air space between this and the wood floor through which air from gratings built into the walls at suitable levels can circulate. In walls



Fig. 13. Hollow walls built to damp proof course level

and partitions, at a height of approximately 6 inches above the natural ground level and below the level of any timber work, a layer of impervious material such as slate, bituminous felt or copper, lead or aluminium alloy foil is placed so that the rising damp cannot pass. The driving rain is kept out by the thickness of solid walls and by the cavity in the hollow walls.

- 8.10 Party walls are usually 9 inches thick solid brickwork, stone masonry, or concrete, for although they appear to be only partitions they separate two adjoining properties and therefore have to be thick to prevent the spread of fire and noise from one house to the next. These party walls are often carried up through the roof to make separation complete, and this can best be seen in a row of terrace houses where they will indicate the extent of each house or group of houses.

- 8.11** The fireplace and chimney stacks are often built as part of the party walls, so that the flues can be formed in one stack for two houses. The chimney stacks are built from their foundations, at the same time as the walls, to well above the roof line and make this wall stronger than the others. Party walls, and end walls which are carried up to the roof top (gable walls), usually carry the strong members of the roof, called "purlins".
- 8.12** Floors in the main are constructed of timber, the strength being given to them by the joists, which are usually about 4 by 2 inches for the ground



Fig. 14. Upper floor joists trimmed for staircase

floor, where they rest on timber wall-plates provided on the outer walls and intermediate dwarf walls. They are of small dimensions as they have only to bridge short distances. The joists for upper floors may be 7 by 2 inches or 9 by 2 inches, according to the distance they have to bridge or span. The ends usually rest on strip iron or timber wall plates to provide a level bearing, or in pockets in the walls.

- 8.13** All joists rest on their narrow edge, as they are stronger in the upright position, and they are usually placed across the narrow way of a room. Over the joists and laid at right-angles to them is nailed the floor boarding, so that the run of joists can be known by remembering that they run the opposite way to the boards of the floor. Where deep joists are used over wide spans, block or "herring bone" strutting is nailed between them across the middle of the span to strengthen the floor by preventing the joists from warping or twisting.
- 8.14** The underside of the joists will carry the ceiling of the room below. This is done by nailing narrow pieces of timber (called "laths") to the joists and at right angles to them. A narrow space is left between the

laths so that when the plasterer presses the soft plaster to them it is squeezed through, making a little bulge in the back which, when it sets hard, secures the plaster to the lathing. This holding arrangement is called the "key" of the plaster. In some buildings expanded metal lathing is used instead of wood laths. The ceiling can also be formed by using specially made sheets of various materials which are nailed to the joists. These sheets may be finished with a thin coat of plaster.

**8.15** It will be seen that all the members of a timber floor are tied together forming a sort of slab which depends for support purely on the walls.



Fig. 15. Details at eaves of roof

**8.16** In some cases parts of the ground floor (such as in sculleries, kitchens etc.) are made solid—that is made in concrete with no space left under them. This floor can be finished with tiles, linoleum or a composition floor surfacing.

**8.17** Roofs in dwelling houses are usually sloping (pitched roofs), although some may be flat and constructed like floors, but having a waterproof external covering. When the walls have been built to the required height, a timber wall-plate is fixed at the top to which will be attached the sloping members of the roof (the rafters). These extend to the apex,

where they are fixed to the ridge board, but if the span of the roof is such that they are not strong enough to do this unaided, they are supported on strong horizontal timber members called the purlins. Purlins usually take their bearings on the party and gable walls where the roof is sloping two ways only, but where there are more than two slopes (in hipped roofs) the purlins are fixed to sloping members (hips) running from the corners of the wallhead to the ridge, and may have struts supporting them from the internal cross walls. A shorter piece of timber called the "collar" is often fixed at about a third of the distance from the top of the roof to a rafter and its opposite number on the other side of the roof to tie them together and counteract outward thrust. Larger roof spans will require trusses, either of timber or steel, to support the purlins.

- 8.18 Resting on the wall-plates and fixed to the feet of the rafters are the ceiling joists, spanning the width of the building in the same direction as the rafters, and taking support from the partitions they pass over. To these ceiling joists is fixed a ceiling as already described. Over the rafters may be fixed boarding, felt and battens for fixing tiles or slates to form weather protection and to keep the house warm.
- 8.19 The bottom edge of the roof (the eaves) usually projects beyond the wallhead to give the wall protection from the weather. From these timbers brackets are framed to which boarding is fixed to enclose the roof space and exclude cold draughts. A channel, known as an "eaves-gutter", is fitted to the bottom of each sloping side to catch the water and conduct it to rainwater pipes which discharge into drains underground.
- 8.20 Another type of roof, called a "mansard", is often used when it is desired to make rooms in the roof space. Each of its sides is formed in two different slopes, and the lower slope, which extends from the eaves gutter to about half way up the roof, is at a steeper slope than the remaining half.
- 8.21 The staircase, usually made of timber and framed up complete in the workshops, is delivered to the site when required in the same way as an item of furniture, and, although not requiring support from the walls, is fixed to them and the floors. The stair does not support the floor, as the joists are usually trimmed to provide a well-hole ready to take the staircase. The vertical part of the step, known as the "riser", is fitted to the level part of the "tread", the ends of both resting on or sunk into the sloping members called "strings", one against the wall, called the wall string, and the other, the outer string, which also carries the balusters supporting the hand rail and finishing at top and bottom on to larger posts known as newels. Underneath the wider type of stair is occasionally to be found a rough sloping member, called a "carriage", its purpose being to provide extra strength.
- 8.22 The water service pipe is often provided with a stopcock in the pavement or path in front of the house so that supplies may be cut off when necessary. There is often a stopcock fitted also just above floor level at



the point of entry of the service into the house. Gas and electricity supplies may be cut off at the meters which are generally to be found under the stairs or in cupboards in the scullery, kitchen or basement.

- 8.23 Basements are provided to some houses, and it is desirable, before entering an old derelict or damaged house, to look for indications of the existence of a basement, evidence of which is usually revealed by the presence of a sunken area to enable admission of light to a window, access stairs, coal-plates, flaps or gratings or perhaps a doorway at a lower level than ground floor.

*(ii) Dwelling House with concrete floors*

- 8.24 Houses of this type are built on the same lines as those previously described, but as little site excavation as possible or necessary will be done in order that the solid concrete ground floors when laid will be at the appropriate level above the ground. To prevent damp rising through the concrete, a layer of asphalt may be placed in the concrete floor making a sort of sandwich. The floor can then be finished to receive linoleum or other floor covering. Alternatively the sandwich layer may be omitted and an impervious floor finish such as asphalt provided.

- 8.25 Upper floors may be formed of timber as previously described or be of precast concrete units or concrete laid in position, reinforced with steel bars for strengthening. The precast type of floor would not be likely to hold together as one slab as well as the "cast in position" type should the walls collapse. Clearing or cutting away a building of this type would be more difficult.

- 8.26 The roof may be of timber as previously described or of concrete, when it would usually be flat and constructed similarly to the floors.

*(iii) Larger houses, blocks of flats and Offices*

- 8.27 The construction of larger unframed buildings will be similar to those previously described although, for stability, the walls of a building having several storeys will be thicker at the bottom than at the top. The load bearing walls within the building will also be constructed to a correspondingly substantial thickness.

- 8.28 If the floors are of timber construction, it is likely the staircases will consist of similar material and, conversely, if the floors are of concrete, the stairs will usually be of concrete.

- 8.29 The roof may be timber or concrete, pitched or flat. Concrete roofs will usually be flat.

*(iv) Unframed buildings of stone masonry construction*

- 8.30 In districts where stone is readily available, foundations and walls will often consist of stone masonry rather than of brickwork. Owing to the irregular shapes and sizes of this stone, walls of this material will generally be found to be thicker than those built with bricks, and walls to two storey houses may be 14 to 18 inches thick. Stones in the footings or foundations will be laid as headers or bonders, i.e., long stones laid

across the thickness of the wall to spread the load as evenly as possible. If the stones are worked on all faces, then the wall need not be any thicker than a brick wall.

- 8.31 More often, however, the wall will be faced with squared rubble or ashlar and backed with random rubble (stone as quarried) or even brickwork. Alternatively the outside and inside faces of the wall may be built as two separate walls held together with "through stones" or "bonders", and the space between filled in with dry rubble, or rubble in mortar. Sometimes the walls are built without any through bonding; such walls are not so strong as walls of similar thickness built in brickwork, and are therefore built in greater thickness than brickwork.
- 8.32 The wall head will be levelled off and timber plates fixed for the roof as previously described. The inside face of the wall may be plastered straight on to the stonework, but very often wooden plugs are driven into the stonework to which battens are fixed to take lath and plaster. This reduces the possibility of damp penetration. Damp-proof courses can be of dense stone, slate, metal or bituminous felt, etc.
- 8.33 Openings in walls for doors and windows are formed as the work proceeds, and usually have dressed stone sills, reveals and lintels. As stone in long lengths breaks easily when loaded, great care has to be taken to ensure that rough arches or, in some cases, wooden inner lintels are formed behind the stone lintels to carry most of the weight.
- 8.34 Staircases may be constructed of wood, but can also consist of hard dressed stone, sometimes having one or both ends built into the walls. The former is known as a cantilever stair, because it receives its support from only one wall and the step immediately below. Balusters, usually iron, are held in position by housing the bottom end of them into holes made in the steps.
- 8.35 Floors will be similar to those already described, but the ground of basement floors may consist of large flat stones known as "flagstones".
- 8.36 Roofs in some cases will be covered with thin stone slabs, necessitating stronger roof timbers to carry the load, but slates or similar finishes as already described will more often be used.
- 8.37 Larger type buildings will be generally similar in construction but will have thicker walls built with very large stones. Floor and roof timbers will also be large.

(v) *Converted buildings*

- 8.38 It should be remembered that there are many cases of domestic buildings, with walls of the load bearing type, which have been converted into industrial or shop premises. This has usually been done by forming wide openings at ground floor level and supporting the upper walls on beams or rolled steel joists carried by steel stanchions or brick piers.

(b) *Partially framed buildings*

- 8.39 Partially framed buildings characterise those that are halfway between unframed and fully framed, i.e., buildings containing a share of each.

The external walls form the unframed section as they are load-bearing, and the framed section comprises the posts and beams erected to replace the thick load-bearing internal partitions. This treatment, it will be observed, permits larger open floor spaces.

- 8.40 Partially framed buildings of an old-fashioned type usually incorporate timber posts and beams, providing support for timber floors, or cast-iron columns, moulded for strength and appearance, and beams of iron and timber or inverted tee section cast-iron. In the more recent buildings of this type, however, the columns and beams are constructed of steel and are similar to those used in modern fully-framed buildings.
- 8.41 The walls in both cases will be constructed in the same manner as in an unframed building but, where the beams enter the wall, the wall will probably be thickened, to form a "pier". The beams will rest on a block of hard stone or concrete, known as a "template" or "padstone", or a steel plate may be used. These blocks or plates spread the load transmitted by the beam and thus avoid crushing of the brickwork; where very heavy loads are imposed, blocks and plates are used together. Whilst the walls will have their continuous concrete foundation, the columns or piers as they are often called will have individual foundations of solid concrete placed deeper into the ground since they have to carry more load.
- 8.42 Floors may be of timber or, alternatively, have low brick arches spanning between the "tee" section beams over which concrete is laid to form a level floor. They may also consist of small steel beams with concrete in between, precast concrete slabs, or hollow blocks set in reinforced concrete.
- 8.43 Roofs may be flat or pitched. A flat roof can be of similar construction to the floors, but if pitched it will probably be of timber and comprise a series of small roofs joined together. Eaves-gutters, or box gutters, formed behind parapet walls, will be fixed to take the water from the outside slopes. Channels are formed in the roof valleys with falls to the outlets at the external wall, so that the water will enter a rainwater head, and descend by the rainwater pipe to the drains.

**(c) Fully framed buildings**

- 8.44 Fully framed buildings are so described because they have a skeleton frame which carries all the loads including the weight of the walls. The frame may consist of steel or reinforced concrete.
- 8.45 Foundations are usually formed individually for each stanchion, and may consist of comparatively small blocks of solid concrete, large reinforced concrete joists or steel joists encased in concrete. Where steel is employed, steel joists may be laid side by side, each layer running at right-angles to the one beneath and bolted together. This type of foundation is known as a "grillage" to which the base-plate of the stanchion is bolted. When the stanchions have been fixed the whole floor area is excavated and covered with solid concrete with or without steel reinforcement.

- 8.46** The frame is formed by fixing the stanchions to the concrete bases or grillages, and fixing between them at suitable levels steel beams which will support the floors and transmit the loads to the stanchions. These stanchions and beams may be encased in concrete or brickwork to protect the steel in case of fire. When the frame is of reinforced concrete, steel rods will be incorporated in the concrete in place of steel stanchions and beams.
- 8.47** Floors are laid on the beams and may be constructed of concrete having steel joists incorporated, called a "filler joist" floor. The joists span from beam to beam of the frame and are placed close enough together so that when solid concrete is placed between them it will support the loads without any further reinforcement. Precast concrete beam floors are constructed of precast reinforced concrete members which span between the beams; they are laid side by side and are jointed and screeded in cement to take the floor finish.
- 8.48** Hollow block floors have rectangular hollow clay or concrete blocks in short lengths laid end to end in rows. Steel rods are placed in the spaces between the rows and concrete grouted around the rods and over the top of the blocks, forming a level surface. The reinforced concrete ribs thus formed between the blocks give the strength to the floor.
- 8.49** Solid reinforced concrete floors have a mattress of steel rods formed between and linking over the beams. The bars are hooked at the ends and wired together where they cross each other. Concrete is poured over and around the rods completely to encase the mattress and form a reinforced concrete slab. In place of a mattress of steel rods, some reinforced concrete floors are constructed with a specially designed mesh of expanded metal, or wire rods, or pierced thin steel sheeting.
- 8.50** Roofs may be flat or partly pitched and partly flat. If flat, they can be formed like the floors and finished on top with asphalt or bituminous felt as desired. If partly pitched and partly flat, the frame is carried up to give the required slope. It can then be concreted and finished in the same way as a flat roof, or covered with metal, or timber may be fixed to the concrete to receive slates or tiles.
- 8.51** The walls can be erected after the floors and roof are in position since these elements do not rely on the walls for their support as they do in unframed buildings. The external walls are merely weather protecting panels placed between the various members of the frame. They may be of any material which will give the necessary weather protection, appearance and stability, the latter quality only in so far as it must stand up securely without deteriorating or becoming a danger to the public or occupants.
- 8.52** Internal partitions, if required to be of heavy construction, for, say, dividing up space for fire protection or for any purpose connected with the user of the premises, will be built over members of the frame, but if they are light partitions forming rooms and corridors they can usually be placed on the floor.

8.53 Staircases will usually be of concrete, reinforced and cast in position, or formed of precast reinforced concrete steps. They may take support from walls, or from steel supports fixed to the frame, or be cantilevered from one wall.

8.54 Shed type framed buildings are single storey framed buildings with pitched roofs and are used mostly for manufacturing or storage purposes. The frame is usually of steel, but sometimes precast concrete units are employed. The ground is excavated, and concrete bases laid at regular intervals for stanchions as previously described. Stanchions and beams are erected and a roof is formed by bolting steel trusses or precast concrete ribs to the heads of the stanchions or beams. Roof trusses are framed of light steel members and arrive on the site in one or two

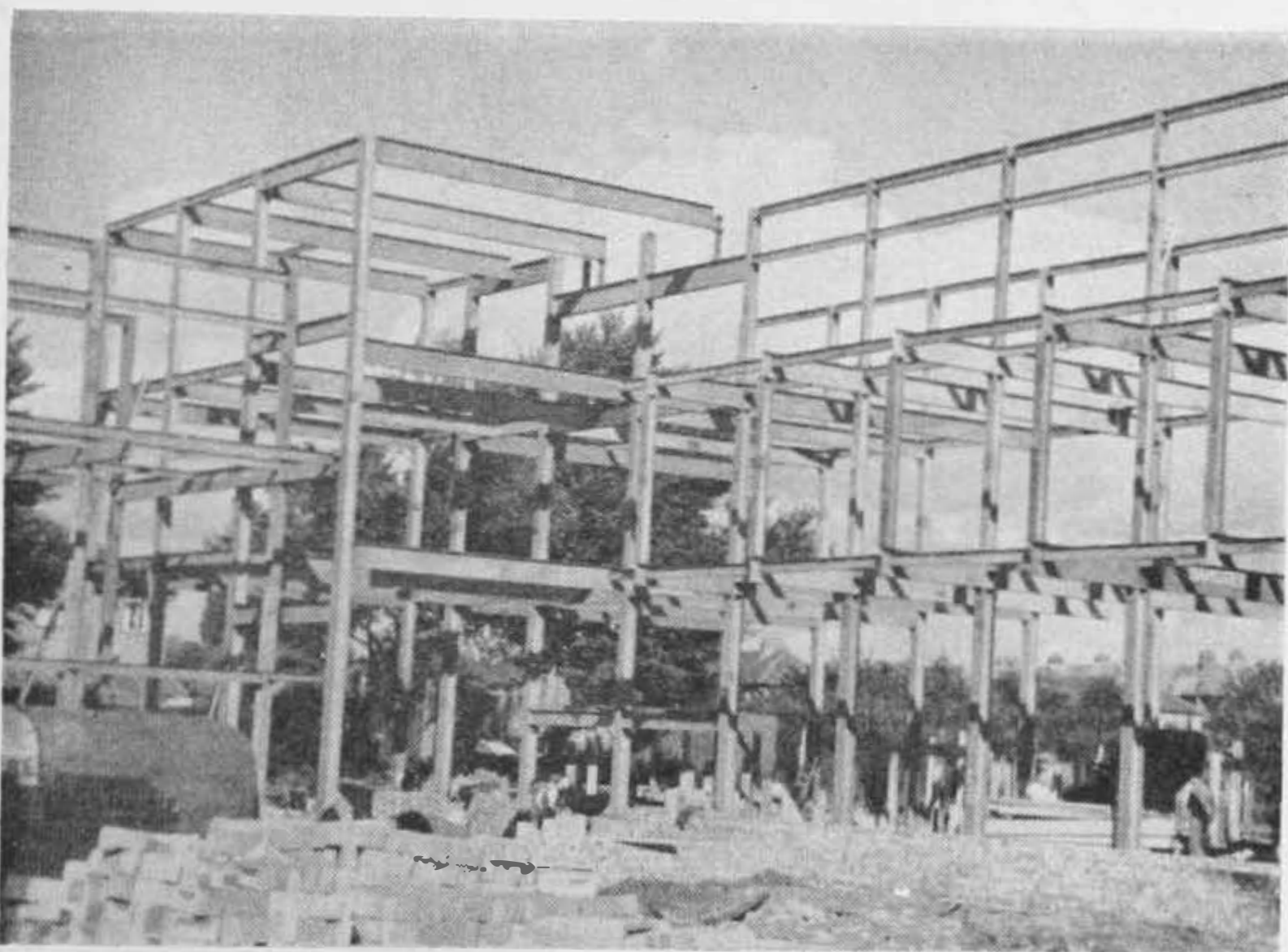

Fig. 16. Typical steel-framed building

sections, ready for fixing in position. Steel beams and angles are fixed between the stanchions giving them support and also to take the wall and roof covering, which is usually of corrugated asbestos or steel sheeting. This sheeting or cladding is fixed with hooked bolts to the steel frame. The walls and roof may be lined to keep the building warm in the winter and cool in the summer. The walls can also be built of brickwork or concrete blocks.

8.55 The steel frame in such buildings is not normally encased in concrete and is not therefore protected against fire. In a severe fire, the steel work may quickly distort and bring about the collapse of the building at an early stage of the fire.

**(d) Monolithic buildings**

8.56 Monolithic buildings, as the name implies, are built in one piece, which means that the foundations, the frame, walls, floors, staircases and roof

are formed of reinforced concrete on the site as they occur in the building as it rises. The mass of reinforcing rods is carefully set out with each bar hooked and wired in position, to form the raft or base of the building and partly up the walls and piers or columns. The timber or metal form-work for the walls is then fixed in position, the steel reinforcement placed and the concrete poured over and worked around the bars. When the concrete is set, the form-work is removed and the next stage proceeds, and so on upwards to the top of the roof, the floors being placed as the walls rise. The roof is constructed in the same manner as the rest of the building, and when the building is completed all the various elements are intimately linked together.

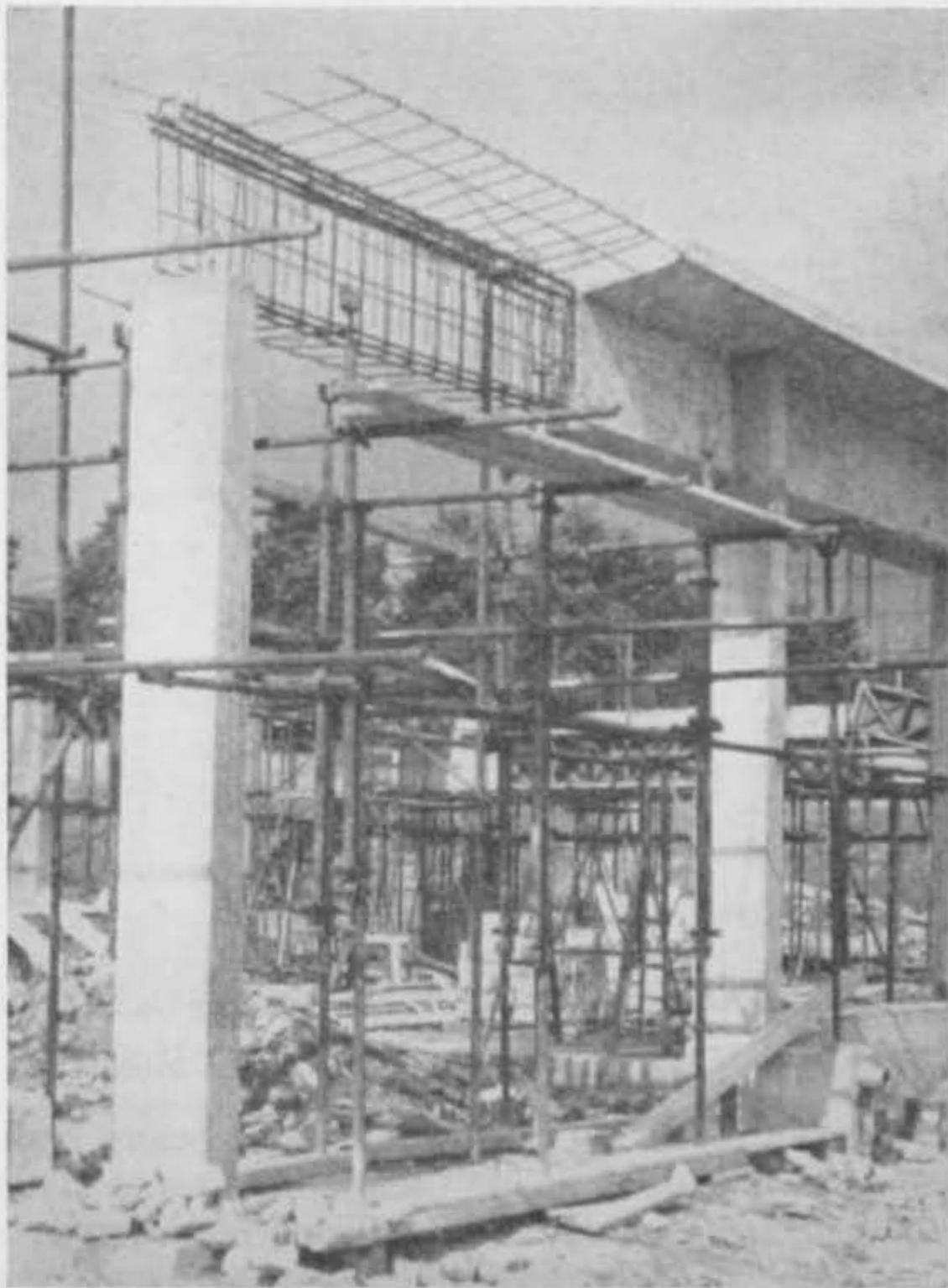

Fig. 17. Typical reinforced concrete building

**8.57** Reinforced buildings of this type may have non-load bearing panel walls similar to steel-framed buildings, or the walls may be designed to share the loads. In either case the building will be very strong and be capable of withstanding considerable blast or damage without danger of the whole building collapsing. Such buildings are also very resistant to fire.

## CHAPTER 9

### Manpack Equipment—Improvisation

#### Rescue tactics

- 9.1 Manpack equipment is essentially immediate action equipment with which much can be done pending the arrival of the specialised rescue equipment issued to each rescue platoon and company. As explained in Chapter 1, the fully trained rescue party no longer goes into action in its own fully equipped rescue vehicle. Parties of manpack-equipped rescue personnel now move to vehicle head in personnel-carrying vehicles (P.C.Vs.) whence they proceed on foot over the debris to their task sites. On arrival there, it is unlikely that they will always work in their normal parties of 8, but far more probable that some members of each rescue party will be allotted able-bodied survivors, ignorant of rescue technique, and without equipment. These they will have to organize and train actually during operations, the only tools available being those in the manpacks carried by the rescue personnel.
- 9.2 In short, every member of a rescue party must now be capable of acting as a party leader of untrained survivors in an emergency, though it is desirable that any such party should always include at least two members of the Rescue Section.

#### The importance of improvisation

- 9.3 It should be clear, therefore, that the keynote of success in rescue work—certainly in the initial stages of operations—is the ability to **improvise**. It is clearly impossible to enumerate or to describe every rescue task or technique to which manpack equipment can be applied. There will of course always be some tasks that cannot be attacked in the absence of the specialised equipment of each rescue platoon, but there will nevertheless be many problems that can be solved with a combination of initiative, commonsense and improvisation.

#### Rules for use of manpack

- 9.4 (a) A rescueman should not 'dump' his pack until it is essential for him to do so to carry out work.
- (b) When he does 'dump', he should place the pack as near as convenient to hand and note carefully the position. This is of particular importance when working at night or in conditions of darkness e.g. cellars.
- (c) Before moving on to a further task the rescueman should quickly check the contents of his manpack and carry it with him to the new task.
- (d) Where there are several man-pack equipped men engaged on the same task, all packs should be dumped in the same spot—the spot

to be selected by the leader or his deputy. In the event of any rescuer being moved to another task he must inform his leader before going that he has collected his pack.

- (e) Generally speaking equipment in manpacks should be used only by trained rescue personnel. Survivors are unlikely to have any knowledge of the use to which these tools can be put, nor sufficient discipline to realise the importance of replacing them in the pack when not required. Survivors should only use these tools when supervised personally by a trained man.
- (f) Manpack equipment is there to be used and not to be left in the pack; therefore use it to the maximum extent.

#### **Suggestions for improvisations using manpack equipment**

##### **9.5 (a) *Blanket***

As improvised stretcher by means of the 'blanket lift', or in conjunction with two 7 feet to 8 feet poles or lengths of timber 2 inch by 2 inches to which the blanket is fastened by safety pins.

##### **(b) *40 ft. 1½ in. lashing***

Raising or lowering casualties from basements or heights respectively; using a chair knot (emergency cases only); using 4 such lashings each fastened to the ends of an improvised stretcher for lowering or raising a casualty; securing a casualty to a stretcher (this must be done in all cases where a casualty has to be moved by hand on a stretcher over debris).

##### **(c) *Short ladder***

Improvised stretcher.

##### **(d) *Brick chisel and club hammer***

For cutting through brickwork or masonry: cutting through metal sections which are too tough for the saw.

##### **(e) *Entrenching tool***

With handle fitted—used as a pick for clearing debris: or as a lever for raising light loads an inch or two.

Without handle—used as a shovel (very useful as such in confined spaces).

##### **(f) *Pliers***

For cutting through wire up to ½ in.

##### **(g) *Webbing bands* (1 long and 1 short in each manpack).**

For use as an improvised stretcher for short distances or to remove casualties to stretchers from positions to which it is not possible to get a stretcher.

##### **(h) *Auger 10 in.***

The auger can be used for making inspection ("peep") holes, or for starting cuts for the saw. It should be noted that no tommy



bar is provided for this with the manpack equipment. It should always be possible to find a suitable piece of wood or metal among the debris which can be adapted for use as a tommy bar.

(i) *General purpose saw*

For cutting through floors, timber, partitions, metal etc.

(j) *Wrecking bar*

For prizing up floors, opening jammed doors, breaking open wooden or composition partitions etc. Can also be used as a small lever and for pulling out and hammering in nails.

(k) *Wire bond*

For use as sling for lifting heavy debris which would otherwise be difficult to manipulate with the hands alone. In conjunction with timber found on the spot, wire bonds can also be used as an adaptable sling in place of levers or jacks etc., e.g. in floor lifting, and for laminating spars to form levers, derricks and sheer legs (see Chapter 10).

## CHAPTER 10

### Some Uses of the Wire Bond

- 10.1** The wire bond is a hemp core galvanized wire rope,  $\frac{1}{4}$  inch in diameter, and 15 ft. in length. One end is spliced, forming a thimble, and the other fused into a ferrule. In good condition it will take a load of approximately 5-cwts. It is also known as a scaffold lashing, and is carried in the manpack by each member of the Rescue Section. It can be used for a number of purposes in rescue work beyond its normal use as a lashing. Some of these are given below.

#### Laminating timber to form a spar

- 10.2** Timbers can often be found on the site of operations, and they will frequently be 4 in.  $\times$  2 in. in dimension, as used in the construction of the roofs of buildings and ground floor joists. Upper floor joists of 6 in.  $\times$  2 in. and 7 in.  $\times$  2 in. may also be available. When using the smaller sections the cross sections of two of the timbers should be equal, and the third should be of a thickness which when lashed to the others should equal their total width, thus making up a rectangular timber. This, and the method of securing these by means of wire bonds using round turns about 4 ft. apart, is shown clearly in Fig. 18. The turns are tightened by driving a wooden wedge under them and this should be about half the width of the timber.



Fig. 18. Securing laminated timbers

#### Another method of laminating timbers to form a spar

- 10.3** It may not always be possible to find timbers of one length in which case it will be necessary to make up shorter timbers into the length required. This is done by staggering the joints of these shorter lengths as much as possible and placing a piece of board, e.g. flooring board, over the joint. The wire bond is then lashed over the board and the joint.



Fig. 19. Improvised lever

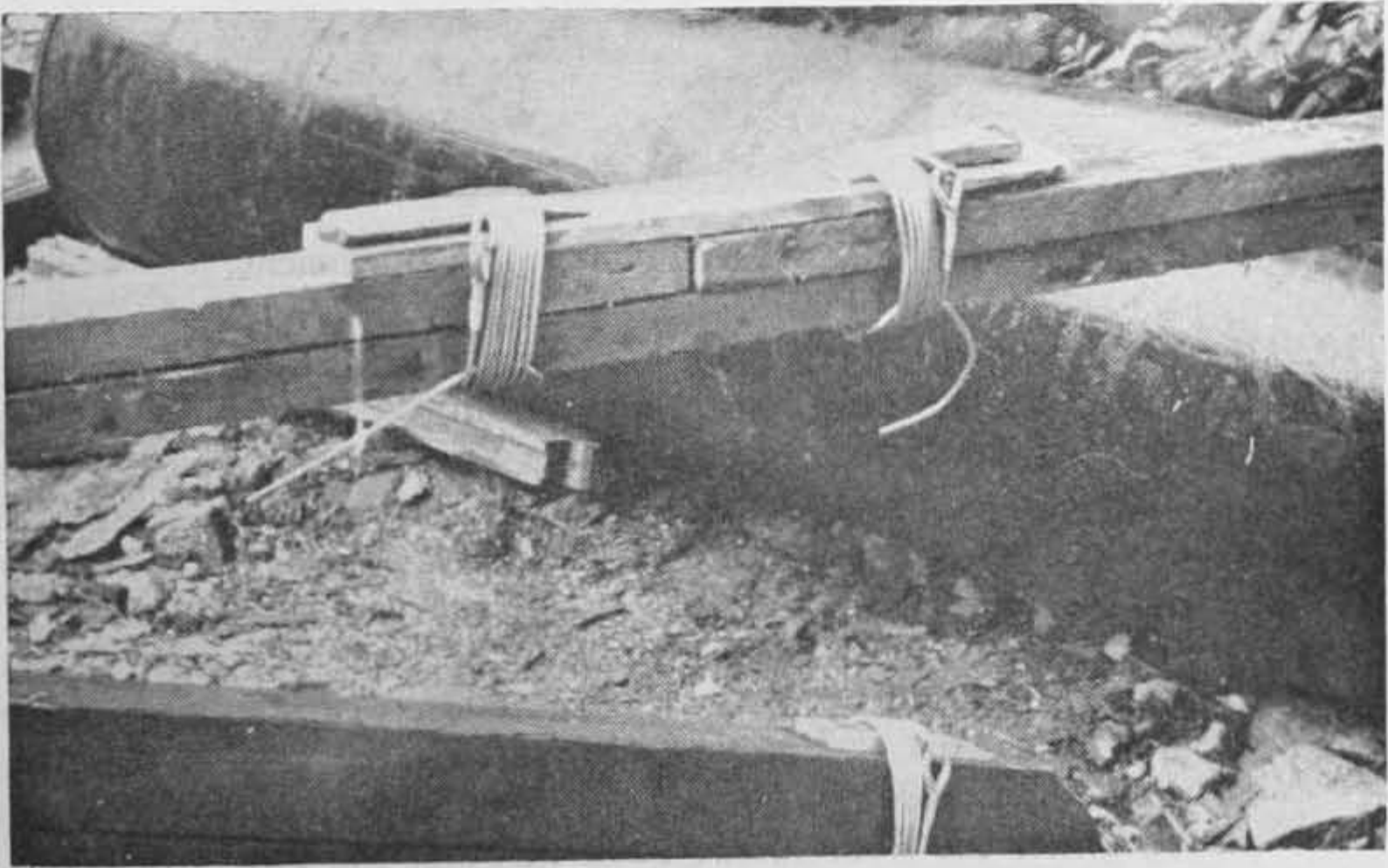

Fig. 20. Another method

## Wire bond

- 10.4** A simple method of making a wire bond sling is by passing the running end of the wire through the thimble, around the back of this, and then passing it underneath itself on the front, thus forming a single bend as shown in Fig. 21. A longer length can be achieved by joining two or more bonds in a similar fashion. Having made the single sling, it can often be doubled or trebled as required according to the size of the load to be lifted.

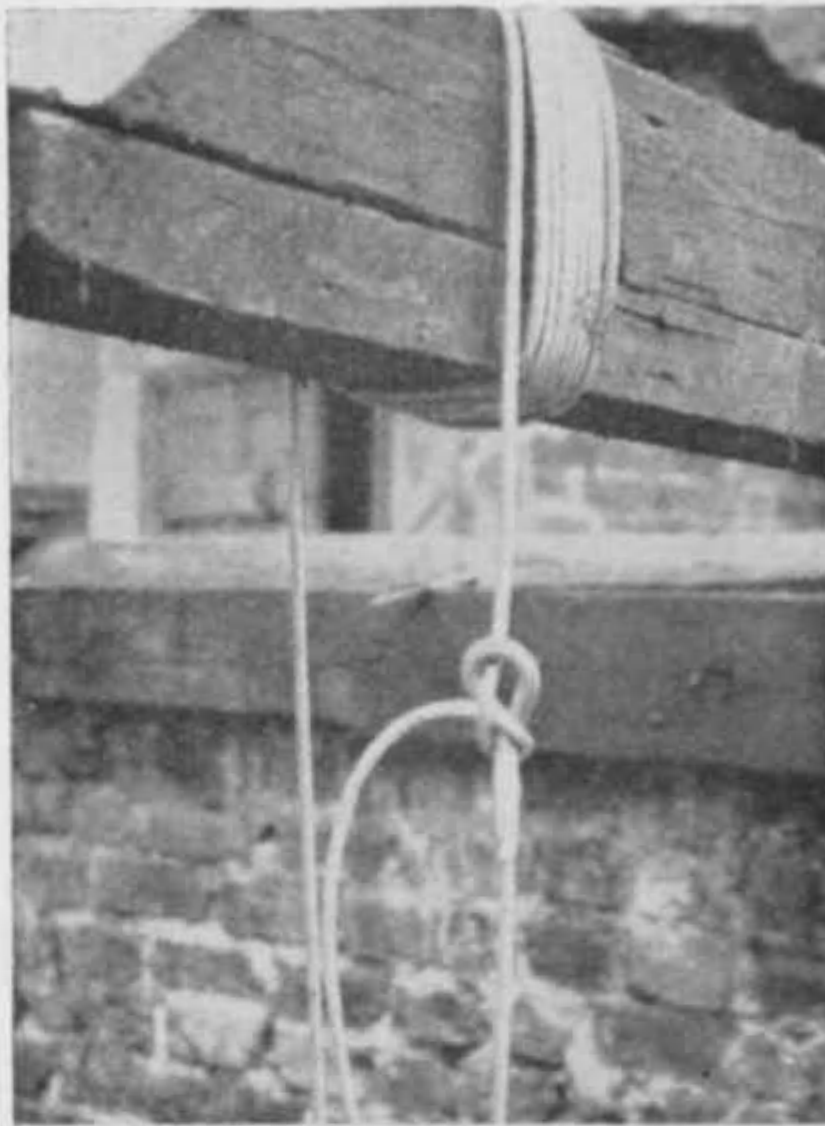

Fig. 21. Wire bond sling attachment

- 10.5** It should be remembered that the greater the number of the returns of the wire the greater the strength of the sling. See Fig. 21. In all applications of the wire bond, the wire can easily be straightened after use by applying pressure to the kinks by the thumb and forefinger of the one hand and feeding to this hand by the other.

### Vertical support of a load

- 10.6** The wire bond can be used in conjunction with a spar to support an unsafe floor. This can be done by passing the end of the wire bond through a hole which has been made in the floor, around a short timber placed under the floor joists, back through the hole, and over a spar positioned on a solid foundation. The sling is then tied off in a single sheet bend.

### Horizontal support of an unsafe wall

- 10.7** A firm anchorage is necessary and this may be found to be a door opening some little distance from the unsafe wall. A piece of strong timber is placed across this opening. The running end of the wire bond(s) is taken round behind this and thence to a timber placed across the unsafe por-

tion of wall. It is passed behind this timber then returned and tied off through the eye in a single sheet bend. A piece of timber e.g. broom handle is then passed through the sling, and the sling twisted by means of this until the timbers behind the door opening and the damaged wall are held firmly in position. The "twisting" timber is then made fast, or anchored by debris at one end to prevent untwisting. See Fig. 22.



Fig. 22. Horizontal support of unsafe wall

#### **Lifting in conjunction with a spar**

**10.8** A floor or heavy load can be lifted by means of the wire bond using this as a sling passed around a spar. The latter will give the necessary leverage for raising the floor or load. The sling is passed under the load to be lifted and the other end over the timbers to be used as a lever. A sound wall or upright spar of sufficient thickness will act as a fulcrum. Power is then applied downward by the man to the lever in the normal way, and this has the effect of raising the other end, the lifting being exerted to the floor or load by means of the sling. See Figs. 23 and 24.

**10.9** A similar technique can be applied to lifting a heavy load such as a block of masonry or girder, except that in this case the wire bond slings are passed under the weight to be lifted. Fig. 24 shows a 10-ft. laminated lever being used to lift a weight of approx. 8-cwts. In this the maximum leverage is shown.

#### **Applying direct lift to a load**

**10.10** The wire bonds can also be used as slings in applying direct lift to a heavy load, such as a large piece of masonry or heavy tank which cannot be manhandled owing to its weight and awkward situation, e.g. in a

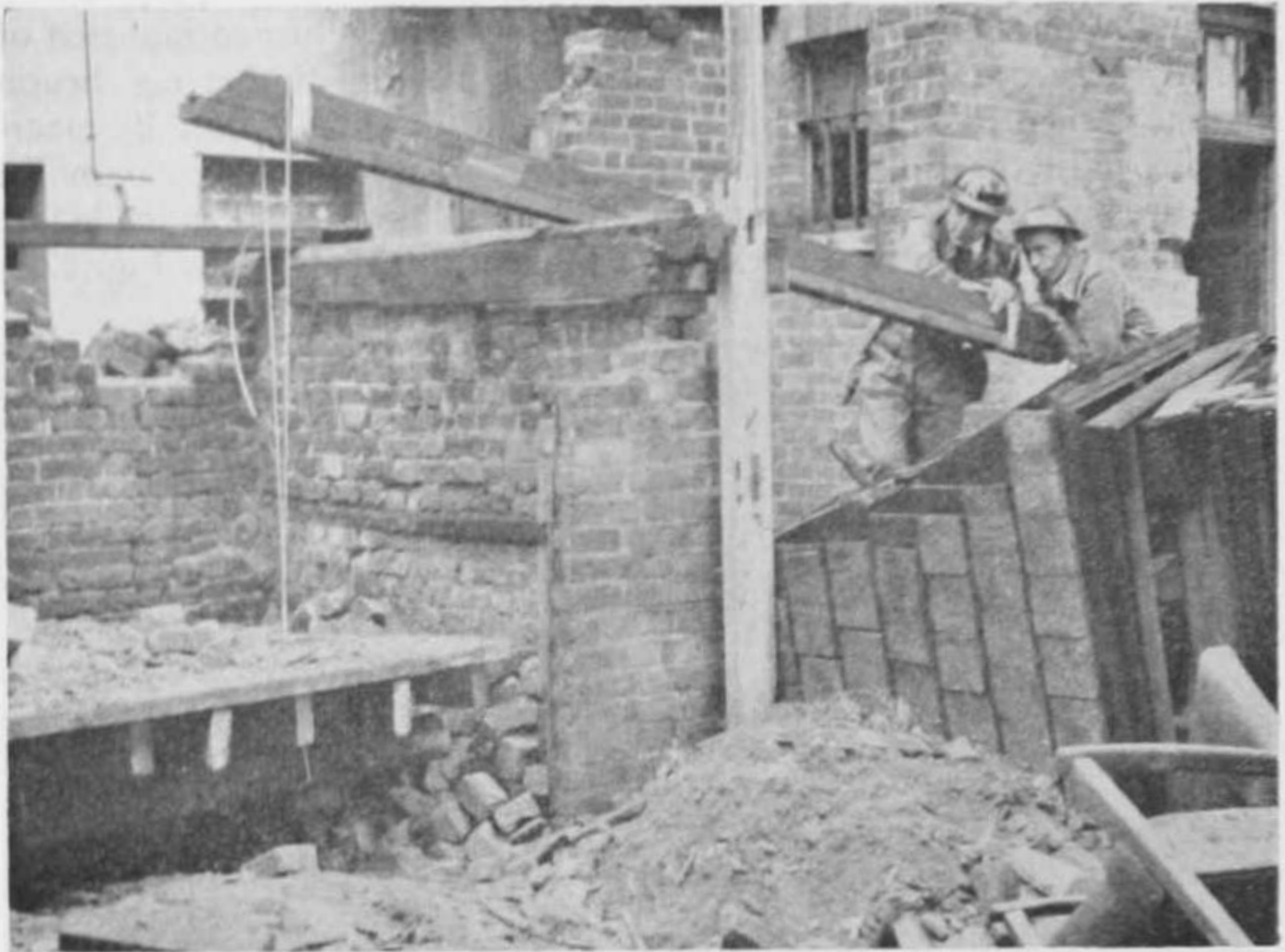

Fig. 23. Wire bond sling in conjunction with a spar



Fig. 24. Another wire bond sling in conjunction with a spar

confined space such as a narrow area in front of a building. In this case the wire bond slings are passed under the load to be lifted. A piece of timber is inserted under the slings above the load and lifting power is applied by men to this spar. See Fig. 25.



Fig. 25. Sling in applying direct lift

## CHAPTER 11

# Casualty Handling in Rescue Operations— Normal Methods

### General principles of casualty handling

- 11.1 The aim should be to prevent further shock and injury by:
- (a) keeping calm thus reassuring the casualty;
  - (b) stopping bleeding with pad and bandage and/or attending to other injuries;
  - (c) keeping the casualty warm;
  - (d) moving and handling the casualty as little as possible when giving treatment;
  - (e) not unnecessarily cutting or removing clothing;
  - (f) removing trapped casualties as quickly and carefully as possible, then taking or sending them towards further medical attention.
- 11.2 Before a casualty is sent away, a note should be made of his name, address and any relevant information he can give. If casualties are unconscious or requiring priority of treatment, etc. a label must be tied to the casualty's clothing giving the necessary particulars—name, address, time and place where found, etc. NOTE: every effort should be made to have unconscious or dead persons identified before sending them away. Rescuers should give this information to the Party Leader at the first opportunity.

### First aid for casualties

- 11.3 The casualty should be given first aid treatment as soon as possible during or after the work of extrication. To some extent the work of extricating the casualty may have to be specially arranged so as to enable this first aid treatment to be given before the casualty is actually released, e.g. crush injuries, etc. Regard must always be had for the *nature of the casualty's injuries* (if these can be determined) during extrication from wreckage, and especially in the handling process necessary to get the casualty away to a casualty collecting point or ambulance loading point, etc.

### Normal method of removing casualties

- 11.4 All seriously injured casualties, and indeed some apparently lightly injured, will require transporting from the point where found, to the Forward Medical Aid Unit. There is nothing better on which to convey a badly injured casualty than a STRETCHER and this should be brought as near to the casualty as practicable. The casualty will require loading on to a properly prepared stretcher; the blanketing



should then be completed and the stretcher carried to the collecting point or loading point. If ambulances are in readiness at the loading point the stretcher must be carefully and correctly loaded into the ambulance.

### Methods and drills for loading a casualty on to a stretcher

**11.5** A casualty may be loaded on to a stretcher with the assistance of webbing bands, by means of a blanket lift, or by the bearers themselves without the use of equipment. These three ways of loading a stretcher are described below.

#### Webbing bands

**11.6** Sets of webbing bands are carried by rescue parties and are used:

- (i) for lifting a patient from the ground on to a stretcher;
- (ii) for lifting and carrying a casualty from a place where it is impossible to use a stretcher.

**11.7** Some of the advantages of webbing bands are:

- comfort for the casualty;
- little effort for the bearers;
- speed if necessary;
- slow movement if advisable;
- heavy casualties can be lifted with ease;
- a casualty can be turned over;
- no undue pressure need be put on any injured part.

**11.8** Each set consists of four bands made of stout canvas webbing  $4\frac{1}{2}$  inches wide and of two different lengths, two being 2 feet long and two 3 feet

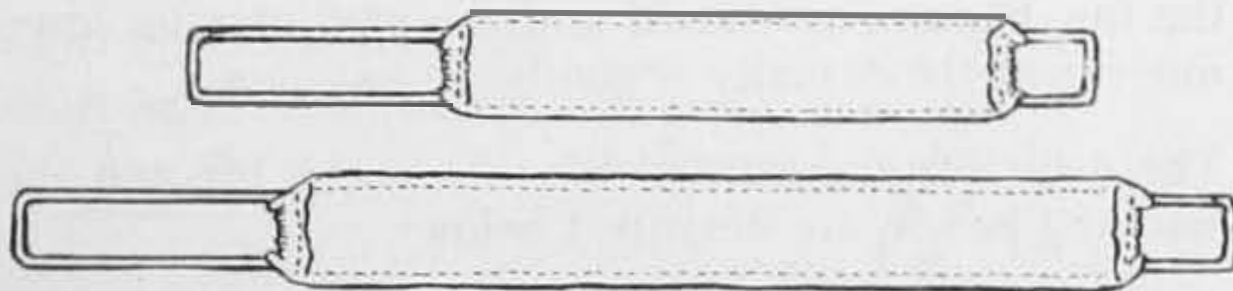

Fig. 26. Webbing bands

long. The shorter bands are intended to go under the head or neck and the feet, and the longer ones under the chest and hips (or small of the back). Each band has a long handle at one end and a short handle at the other. The handles are made of  $\frac{1}{4}$  inch drawn steel wire welded at the joint, the long handle being 12 inches long and the short 4 inches. The long handles are used for pushing under the body of a casualty lying on the ground, after which the webbing band is pulled through so that there is a handle at each side.

**11.9** *To insert a band* the bearer grasps the long handle with his right hand at the point where the handle joins the canvas and, slightly raising the casualty with his left hand, he pushes the handle under him. The bearer on the other side raises the casualty slightly with his left hand and pulls the handle and band through with his right hand. The casualty need be raised only a quarter of an inch, i.e. the thickness of the metal handles.

**11.10** When a casualty is lying close to a wall or other obstruction it is not possible to pull the long handle through, so the short handle is bent over the long handle and pushed through by it; the short handle is then pulled through and the long handle withdrawn simultaneously.



Fig. 27. Inserting bands

**11.11** To turn a casualty from the prone to the supine position, or vice versa, the bearers proceed as for a normal lift but ensure that the four handles on one side are close to the body. The bearers then lift the casualty off the ground with the handles on one side low and on the other side high; the low handles are raised and the high handles lowered, and by this movement the casualty is gently turned over.

**11.12** The drills for the normal lift, the heavy lift and the wall lift, using webbing bands, are described below.

**11.13** *The normal lift*

*Position of bands:*

- (a) Short band under head (supporting band only)
- (b) Long band under shoulders
- (c) Long band under pelvis
- (d) Short band under calves.

*Inserting of bands:*

*1st Stage*

No. 1 bearer to left of casualty at shoulder with long band, pushes through.

No. 2 bearer to right of casualty pulls above band through.

No. 3 bearer to left of casualty at calves with short band, pushes through.

No. 4 bearer to right of casualty pulls above band through.

### *2nd Stage*

No. 1 bearer pushes short band under head.

No. 2 bearer pulls short band under head.

No. 3 bearer pushes long band under pelvis.

No. 4 bearer pulls long band under pelvis.

NOTE: All bands in this lift (unless casualty needs turning, see para. 11.11) must be centralised in order to get a level lift.

### *Position of bearers*

No. 1 and No. 2 take head and shoulders.

No. 3 and No. 4 take feet and pelvis.

The casualty is now raised and placed on the stretcher.

*Orders*—by No. 1 bearer

“Prepare to Lift”—Bearers take appropriate handles in each hand, standing close to casualty.

“Lift” —Bearers lift together and take a short pace forward, close up to casualty to prevent his swaying.

The stretcher is now loaded.

**11.14** *The heavy lift*—for lifting very heavy casualties where five bearers are available.

### *Position of bands:*

- (a) Long band under shoulders
- (b) Long band under small of back
- (c) Short band under thighs
- (d) Short band under calves.

### *Inserting of bands:*

#### *1st Stage*

No. 1 bearer to left of casualty at shoulders with long band, pushes through.

No. 2 bearer to right of casualty, pulls above band through.

No. 3 bearer to left of casualty at calves with short band, pushes through.

No. 4 bearer to right of casualty, pulls above band through.

#### *2nd Stage*

No. 1 bearer at small of back, with long band, pushes through.

No. 2 bearer pulls above band through.

#### *3rd Stage*

No. 3 bearer at thighs with short band, pushes through.

No. 4 bearer pulls above band through.

The bands are centralised, unless the casualty needs turning (see para. 11.11), and dropped to the ground.

### *Position of Bearers*

Nos. 1 and 2 bearers take bands (a) and (c) (see Fig. 28).

Nos. 3 and 4 bearers take bands (b) and (d) (see Fig. 28).

NOTE: Another bearer is co-opted to support the head.

The casualty is now raised and placed on the stretcher.

*Orders*—as in the normal lift.

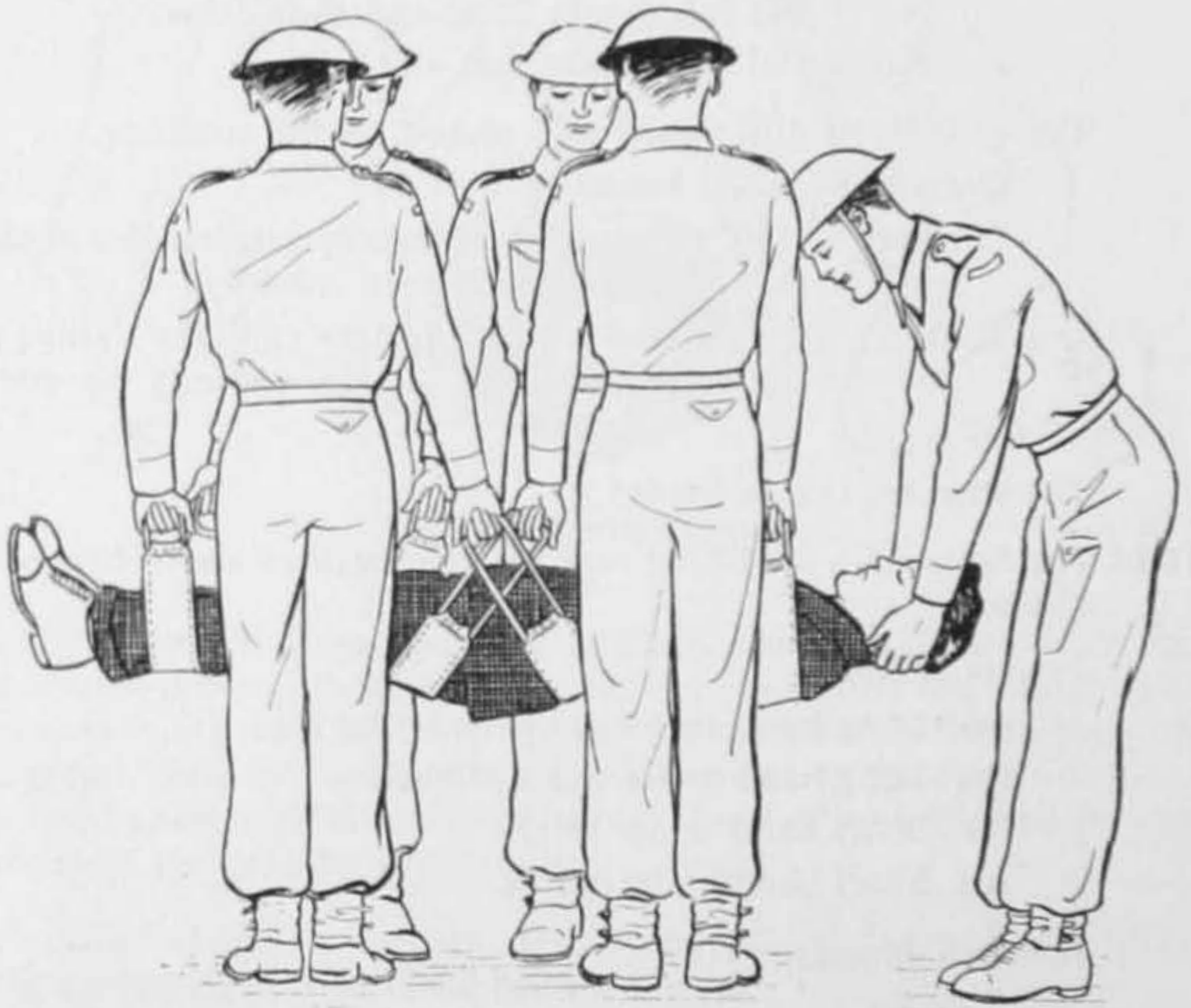

Fig. 28. Heavy lift

NOTE: This method may be adopted for moving a *spinal* casualty in which case the bearer at the head maintains gentle traction (on the head). Where it is certain, or suspected, that the fracture is in the lumbar region, a sixth fully trained bearer is necessary to apply gentle traction to the feet and legs, while the fifth bearer supports but does not maintain traction on the head.

### **11.15** *The wall lift*

#### *Position of bands*

Three only as in the normal lift.

#### *Inserting of bands*

See para. 11.10 and Fig. 29 (a) and (b) opposite.

### *1st Stage*

No. 1 bearer at shoulders, long band, pushes through.

No. 2 bearer at shoulders assists and pulls through.

No. 3 bearer at calves, short band, pushes through.

No. 4 bearer at calves assists and pulls through.

### *2nd Stage*

No. 3 bearer at pelvis, long band, pushes through.

No. 4 bearer at pelvis, assists and pulls through.

Bands are centralised unless the casualty needs turning (see para. 11.11).

### *Position of Bearers*

No. 1 bearer supports the head

No. 2 bearer at shoulders

No. 3 bearer at pelvis

No. 4 bearer at feet

} facing head of casualty.

When the appropriate orders have been given each bearer takes up the handles of the band in front of him—the casualty is raised and may be turned, or moved, as required. N.B. The normal lift may be reverted to—and casualty placed on the stretcher.

### **Loading by means of a blanket**

**11.16** Four bearers are required for a blanket lift. A blanket is placed lengthwise on the ground in line with the casualty and rolled up for half its width. The casualty is carefully turned on his side. The rolled portion of the blanket is then placed close to the casualty and he is gently eased



Fig. 29 (a). Wall lift—inserting of bands



Fig. 29 (b). Bands in position

over the roll so that his back rests upon the unrolled portion; the rolled portion is then unrolled so that he lies in the centre of the opened blanket. The two edges of the blanket are then rolled up against the casualty's body and grasped by two bearers on each side, all four bearers acting together lift the casualty. A fifth bearer, if available, slides the stretcher under him. If there is no one to slide the stretcher under the casualty, the bearers should move with short smooth side paces until the casualty is over the stretcher; and then slowly lower him on to it.



Fig. 30. Blanket lift

- 11.17 If only three bearers are available, one should go to each side of the casualty and grasp the edge of the blanket with his hands wide apart and opposite to the casualty's shoulders and hips, while the third bearer supports the head. All three bearers acting together lift the casualty and carefully lower him on to the stretcher.
- 11.18 When a casualty is being removed from a void, space may not permit of the use of a standard stretcher. In these cases a blanket lift may be more comfortable for the casualty and easier for the party to handle.
- 11.19 The blanket lift may be used, with certain additions, for spinal cases.

#### **Loading by bearers without equipment**

- 11.20 Four bearers are required for the "bearers' lift".

#### *Positions and procedure*

No. 1 bearer on one side of the casualty at his hips.

Nos. 2, 3 and 4 on opposite side.

No. 2 bearer (feet and legs) at casualty's knees.

No. 3 opposite No. 1 at casualty's hips.

No. 4 (head and shoulders) at casualty's shoulders.

All kneel on left knee and pass their hands beneath the casualty.

Nos. 1 and 3 join hands on a hook grip.

On orders from No. 1 the casualty is carefully lifted on to the knees of Nos. 2, 3 and 4.

No. 1 can then position the stretcher, return to his former position, join hands with No. 3 and on the given command the bearers lower the casualty on to the stretcher.

#### **Blanketing a stretcher**

- 11.21 Before a casualty is laid upon a stretcher, it must be covered with a blanket folded lengthwise, (or an overcoat), so that he does not lie directly upon the canvas. This adds to his comfort and reduces shock. It is more important to put blankets under him than over him. With two layers of blanket underneath and one on top a casualty is better off than with one layer underneath and two on top.

#### *With two blankets*

- 11.22 Two blankets only are required to blanket a stretcher properly. The way to do it is as shown in Figs. 31 a-c.
- (i) lay one open blanket (A) lengthwise across a stretcher with one side close to the head end, and one end of the blanket having a slightly longer overlap of the stretcher than the other.



**Fig. 31 (a). Blanketing a stretcher**



**Fig. 31 (b). Blanketing a stretcher**





Fig. 31 (c). Blanketing a stretcher



Fig. 32. R.A.M.C. method with two blankets

(NOTE: R.A.M.C. teaching is that this blanket is to be placed on the stretcher in similar fashion to the above but the top side of the blanket should be positioned halfway down the stretcher handles at the head end of the stretcher (see Fig. 32)).

- (ii) Fold a second blanket (B) in three folds lengthwise and lay it on top of the first blanket (A) along the stretcher with its upper edge about 15 in. below the upper edge of the first blanket (A). There will now be four thicknesses of blanket upon which the casualty will lie.
- (iii) Open out the two ends at the foot of blanket (B) for about 2 ft. to form two flaps.
- (iv) Pleat in concertina fashion the overhanging ends of blanket (A) and place them on the edges of the stretcher so that they will not drag on the ground when the stretcher is brought close to the patient.
- (v) When the casualty is laid upon the stretcher, wrap the two flaps of blanket (B) round his feet and tuck the ends between them.
- (vi) Open out the rolled up folds of blanket (A) and wrap first the short then the long end round the patient, tucking it well in at one side.

The casualty will now be warmly blanketed.

*To secure blankets as a pack on a stretcher*

- 11.23
- (i) Lay blankets (A) and (B) on the stretcher as described in para. 11.22(i) and (ii) above.
  - (ii) Fold in the two edges of blanket (A) taking the folds to the sides of the stretcher twice, then once again on to the stretcher.
  - (iii) Place the foot-end of blanket (B) on the stretcher, then fold it over and over with blanket (A) to form a flat pack. Secure the pack thus formed to the stretcher with a strap passed round it and the stretcher.

*With one blanket*

- 11.24 It may be that only one blanket is available for blanketing. This can be used in the following manner (Figs. 33(a) and (b)):
- (i) place blanket diagonally over the stretcher
  - (ii) wrap from side to side and tuck in
  - (iii) wrap head and feet.

**Stretcher Lashing**

11.25 During rescue operations there is a possibility:

- (a) of the bearers stumbling and of debris moving with a consequent risk of the casualty being thrown off the stretcher;

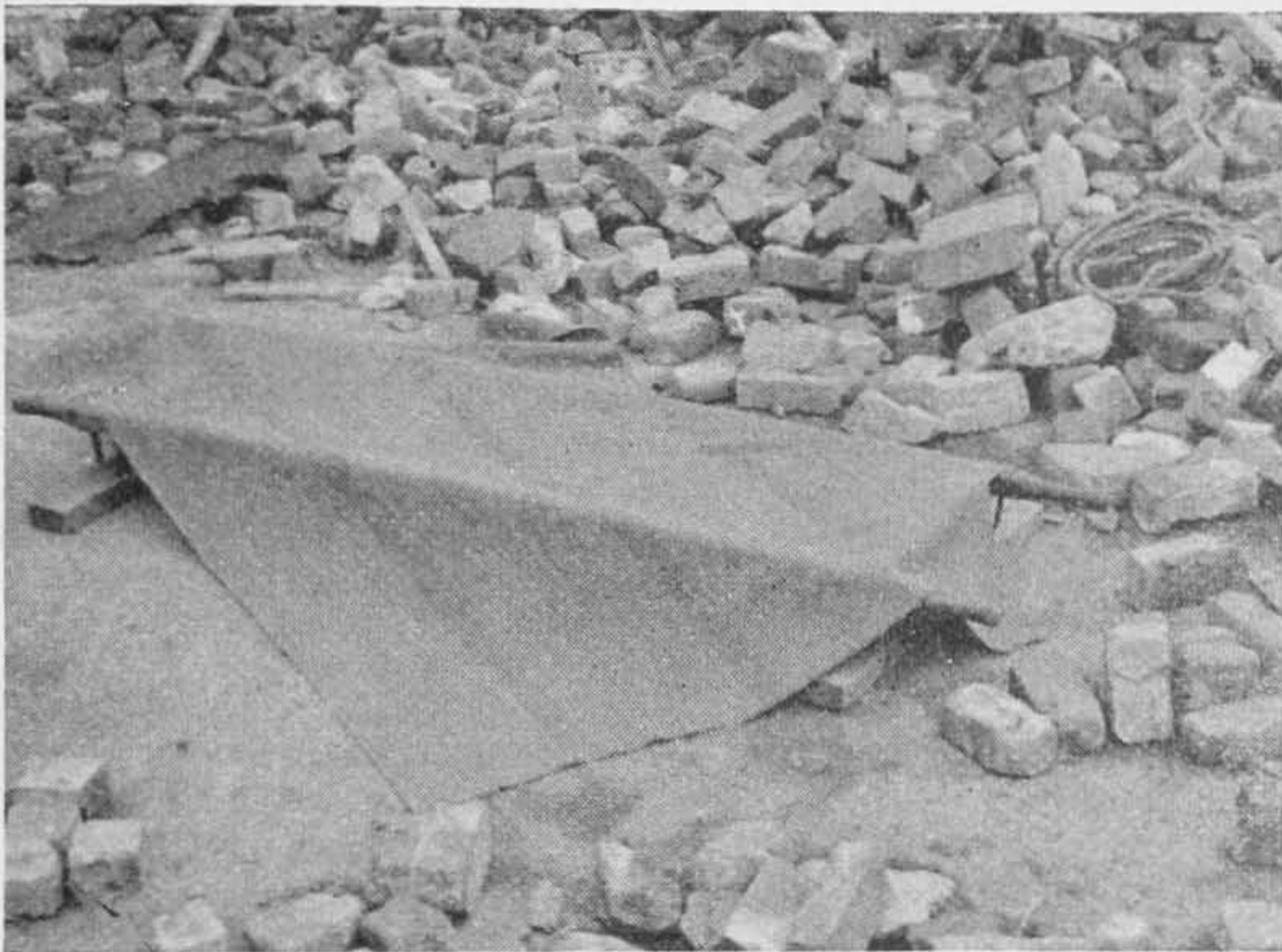

Fig. 33 (a). Blanketing a stretcher with one blanket



Fig. 33 (b). Blanketing a stretcher with one blanket

(b) in some instances of the stretcher having to be turned on to one side, or up-ended, to pass some obstructions, or lowered or raised by ropes;

(c) the casualty may be tossing about.

In view of these possibilities it is necessary for the casualty to be "secured" to the stretcher.

**11.26** This is done by improvising with the 40 ft. lashing line. Form a clove hitch on one of the stretcher handles near the head of the casualty, pass the lashing down the side of the stretcher taking a complete turn under the stretcher and back over the casualty's chest. Form a half-hitch on the side of the stretcher and repeat the operation above the casualty's knees (over hips or thighs) and again just below the knees.

**11.27** Take a complete turn of the lashing around the casualty's feet, then working up the other side of the stretcher make half hitches on the side of the stretcher at each point where the lashing crosses the casualty, and finish off with a clove hitch on the opposite handle. Care should be taken to prevent the turns and the half hitches of the lashing from pressing on injuries to the casualty.

**11.28** Quick release is obtained by the following method when a 40 ft. lashing has been used. Two men, one on each side of the stretcher, undo both clove hitches and working in unison proceed towards the casualty's feet, gently releasing by a slight pull on the lashing the turns around the casualty; they then remove the turn around the feet and release the lashing from under the stretcher.



Fig. 34 (a). Stretcher lashing



Fig. 34 (b). Stretcher lashing



Fig. 34 (c). Stretcher lashing



Fig. 34 (d). Stretcher lashing

### Stretcher Drill

11.29 It is essential that rescue men should receive some training in the form of drill for correct carriage and practice in loading, unloading and handling stretchers. Any form of drill must of necessity be modified to meet war conditions and cannot be too rigidly followed. The result of an efficient training, however, will be to promote and maintain concerted action and good team work among rescue personnel. The No. 1 bearer gives all orders.

#### *Lifting a stretcher*

11.30 Four men of approximately the same height are allotted as bearers to carry each stretcher. For convenience they are numbered 1, 2, 3 and 4, each four men constituting a stretcher squad. The No. 1 bearer of each squad is the leader and gives all orders. The positions which these bearers take up in relation to a stretcher are:

- (a) No. 1 on the right of the stretcher with his toes in line with the front end of the right pole.
- (b) No. 2 on the left of the stretcher in line with No. 1.
- (c) No. 3 on the right of the stretcher behind No. 1 with his heels in line with the rear end of the right pole.
- (d) No. 4 on the left of the stretcher in line with No. 3.

These positions are permanent.

11.31 On the command "lift stretcher—collect wounded" all four bearers stoop together and lift the stretcher from the ground with the hand nearest to the stretcher. They then go by the shortest route to the patient and halting three paces from and in line with his head, place the stretcher on the ground and stand up to await further orders.

### *Loading a stretcher*

- 11.32 On the command "Load stretcher" No. 1 bearer goes to the right of the casualty at his hips, Nos. 2, 3 and 4 to the left of the casualty at his knees, hips and shoulders respectively. All bearers now turn inwards together, kneel on the left knee and pass their hands, palms upwards, beneath the body of the casualty, No. 2 bearer supporting the legs, Nos. 1 and 3 (by joining hands) the thighs and hips, and No. 4 the shoulders and head. At a given signal the casualty is lifted gently off the ground on to the knees of Nos. 2, 3 and 4 bearers, No. 1 disengages and brings the stretcher which he places in front of the bearers ready for the casualty to be lowered on to it. He then takes up his former position and again links hands with No. 3. On the command "lower" the casualty is lowered gently on to the centre of the stretcher, the bearers disengage, rise and resume their permanent positions at the poles of the stretcher.

### *Loading a stretcher with only two bearers*

- 11.33 The stretcher is again placed in line with the casualty. After giving first aid the two bearers stand astride the casualty facing the stretcher. The casualty's arms are folded across his chest if he is unconscious, but if not, he may be able to help by grasping the leading bearer round the neck with one or both hands as he bends down. The bearers both bend together, lift the casualty by the shoulders and thighs, and shuffle forwards straddling the stretcher as they reach it.

### *Lifting and carrying the loaded stretcher*

- 11.34 On the command "Prepare to lift" all bearers stoop together, with bended knees and back erect, and grasp the stretcher poles. On the command "Lift stretcher" the stretcher is lifted at the full length of the bearers' arms. At a given word of command they step off together with the inner foot, i.e. that nearest the stretcher, so as to be out of step to prevent the stretcher from swinging. Should there be only two bearers, the front bearer will step off with the left foot and the rear bearer with the right foot.
- 11.35 Normally it is easier for the bearers to carry a casualty feet first, but when going uphill it is more comfortable for him to be carried head first, unless there is some reason to the contrary.

### **Handling a stretcher in difficult situations**

- 11.36 A stretcher should, whenever possible, be carried in the horizontal position. There may be times when this is impossible as the casualty may have to be carried over debris and bearers will have to climb up and down piles of rubble. In such cases 4 or 6 bearers are an advantage.
- 11.37 If four bearers are available, one should be at the front end, one at the rear end, and one at each side of the stretcher. When they have to climb over an obstacle or a heap of debris, the bearers at the sides turn inward towards one another and take the full weight of the front end of the stretcher, while the front bearer climbs up on the debris; the front end of the stretcher is then lifted for him to grasp. The stretcher is then



Fig. 35. Moving a stretcher over debris

advanced, and the bearers at the sides take the weight of the rear end of the stretcher, while the rear bearer climbs on to the debris and grasps the rear end. A similar procedure is adopted when climbing down (see Fig. 35). If only two bearers are available, it may be necessary to lay the stretcher down when they reach an obstruction so that they can ascertain the best method of getting over it. The bearer at the front end climbs on to the debris while the bearer at the rear end passes the front end of the stretcher up to him to grasp. The rear end bearer then resumes his position and lifts the stretcher to a horizontal position and the bearers cross the obstacle. Care must be taken to see that the stretcher, if laid down, is resting on each "D" with the bed of the stretcher clear of obstruction so that debris will not move under the weight of the casualty or injure him.

*Using a stretcher in a confined space*

- 11.38** In confined spaces, if there is sufficient height and the casualty has been secured to the stretcher, it may be stood on end and, by grasping the sides, can be moved round sharp corners. Where the height is insufficient to permit of this method being used, as in the case of shelters, a compromise between the horizontal and vertical positions is necessary. The casualty should be carried feet first as far as the middle of the right-angled bend, where the front end of the stretcher is placed on the ground and the rear end lifted as high as the roof will permit. The stretcher can then be worked round the bend, one bearer easing the front end and another the rear end. It should not be turned on its side or height will be lost and difficulties increased. At the same time there will be a risk of the casualty banging against the inside of the bend.



### *Crossing over gaps*

- 11.39** *Gaps in floors:* When taking a casualty out of a damaged building it is often necessary to cross a gap in the floor. A ladder may be used as a bridge providing that the precautions outlined in Chapter 17 are followed. Alternatively, two or more joists may be laid across the holes as illustrated in Fig. 36. They should be twice as long as the hole to ensure that they rest on the sound joints of the damaged floor.



Fig. 36. Carrying a stretcher over a gap

- 11.40** *Gaps in debris:* It is wise to use six bearers as a safety precaution when crossing a pile of debris which contains gaps. Two bearers go across the gap while the remaining bearers turn inwards and, lifting the stretcher, pass the front handles to them across the gap (See Fig. 37). The two rear bearers support the stretcher as it goes over then relieve the front bearers, who cross the gap and take up their position ready to take over the rear end of the stretcher. The remaining bearers then cross the gap and take up their position at the sides of the stretcher.
- 11.41** *Bridging a gap:* The ladder, ladders or timbers must be quite long enough to bridge the gap and give adequate support at either end.

### **Ambulance loading**

- 11.42** Ambulance personnel remove stretchers from an ambulance at the ambulance loading point so that an empty rack is always available



Fig. 37. Passing a stretcher over a gap



Fig. 38. Bridging a gap

immediately a casualty is brought to an ambulance. Stretchers and blankets removed are placed at the side of the ambulance where they will not be in the way of loading.

**11.43** Casualties should generally be loaded into an ambulance head first. The order of loading, unless there is any special reason to depart from it, is:

- Upper berth (off side)
- Upper berth (near side)
- Lower berth (off side)
- Lower berth (near side)

**11.44** If the stretcher is brought to the ambulance by four bearers:

- (i) The stretcher is lowered to the ground one pace from and in line with the vehicle, the patient's head towards the vehicle.
- (ii) No. 1 bearer, having satisfied himself that the ambulance is ready for loading, will assume his position and give the command "Load".
- (iii) All four bearers turn inwards, lift the stretcher together and, taking a side pace to the ambulance, arise the stretcher gently and evenly to the level of the berth to be loaded; (for an upper berth the "shoulder carry" may be used).
- (iv) Nos. 1 and 2 bearers place the front "D's" of the stretcher on the tracks and then assist Nos. 3 and 4 bearers to slide the stretcher into its place.

The ambulance attendant guides the stretcher and secures it in position.

## CHAPTER 12

# Casualty Handling in Rescue Operations— Improvised and Emergency Methods

### Improvised stretchers

- 12.1** When there is a shortage of stretchers it is better to improvise rather than manhandle the casualty unnecessarily. An old door, a sheet of galvanised iron, a blanket, or a short ladder are all examples of improvisation.
- 12.2** The method of blanketing a door is the same as for blanketing a stretcher (see paras 11.21-24). One method of securing the casualty to the door, with the exception of the start and finish, is the same as the stretcher lashing. With this particular lashing, start at the head end with a complete turn around the door, making fast with a clove hitch on the standing part of the rope, and then continue down the side of the door as for the normal stretcher lashing, up the opposite side to the first turn around the door, there make a turn on the rope on the top side, over the door and complete with a clove hitch on the rope on the opposite side of the door, or come back to the round turn around the door and finish with a clove hitch, as clearly shown in Figs. 39 a-b. Another method is to leave about 1 ft. of rope beyond the centre of the door at the head end. The rope should be pinned between the brick supporting the corner of the door and the door itself before proceeding to the actual lashing of the casualty to the door. To finally secure this lashing the running end of the rope should be passed over the door and tied off with a reef knot on the top edge of the door (see Figs. 39 c and d).
- 12.3** One method of using a blanket as a stretcher is described in para. 11.16. Another way of using a blanket is to first lay the blanket on the ground or the floor and then place two short broom handles, poles or pieces of timber about 6 ft. in length, or whatever are used for the supports, across the narrow width of the blanket, approximately 2 ft. apart, then take one edge of the blanket and fold over the pole furthest away and tuck underneath as shown in Fig. 40(a). Then take the second edge of the blanket, fold over to the opposite fold and tuck underneath (Fig. 40(b)). Then fix the three thicknesses of the blanket together on the outside of the pole with safety pins or nails as shown in Figs. 40(c) and (d).
- 12.4** The ways in which webbing bands can be used to improvise a stretcher are described in paras 11.6-15.

### Emergency Methods

- 12.5** When casualties are in danger from fire, coal gas, flooding or dangerous structures such as leaning walls, it is necessary to remove the cause of danger from the casualty, or the casualty from the danger. If it is vital



Fig. 39 (a). Using a door as a stretcher



Fig. 39 (b). Using a door as a stretcher



Fig. 39 (c). Using a door as a stretcher



Fig. 39 (d). Using a door as a stretcher



Fig. 40 (a). Another form of improvised stretcher



Fig. 40 (b). Another form of improvised stretcher



Fig. 40 (c). Another form of improvised stretcher



Fig. 40 (d). Another form of improvised stretcher



to remove the casualty to safety, he must be moved regardless of his injuries, but only when the casualty is in imminent danger of death by remaining where he is does removal take priority over the stoppage of bleeding. There are several methods by which he can be moved, among them the pick-a-back, human crutch, fireman's lift, rescue crawl, fore and aft method, two and four handed seats. These are described and illustrated below. EMERGENCY METHODS SHOULD ONLY BE USED WHEN TIME WILL NOT PERMIT THE USE OF MORE NORMAL METHODS.

#### Methods of hand carriage suitable for one rescuer

##### *Pick-a-back*

- 12.6** Carry the casualty in the ordinary pick-a-back position. This is the best way if he is conscious and able to hold on.

##### *Human crutch*

- 12.7** Where the casualty can help himself the rescuer stands at his injured side and places the casualty's arm round his shoulder, grasping the wrist with his hand. At the same time he passes his other hand round the casualty's waist gripping his clothing at the hip, and thus assists him



Fig. 41. Human crutch

by acting as a crutch. Each person should step off with the outside foot—the rescuer using his nearest to the casualty as a prop—as in a three legged race.

#### *Fireman's Lift*

- 12.8 This is one way of carrying a helpless or unconscious casualty and allows the bearer a free hand. It is easier for the bearer than pick-a-back, but not so comfortable for the casualty. Various stages of the lift are shown in Figs. 42 a-d.
- 12.9 If the casualty is lying on his back, kneel on one knee (usually the right) at his head, place the right hand upon his right shoulder, and with the left hand beneath his left shoulder turn him over gently on to his face so that his forehead and face are supported on the right forearm (see Fig. 42(a)). Place your hands beneath the casualty's shoulders and lift him up to a kneeling position, supporting him against the body with his head on your right shoulder.
- 12.10 With your hands in the casualty's armpits stand up and lift him on to his feet, pressing his body close to your own; shift your hands from his armpits and clasp them together round his waist (see Fig. 42(b)).
- 12.11 Keep your right arm round the casualty's waist and grasp his right wrist with the left hand, carrying the limb away from the body. Stoop and place your head beneath his right arm and hoist him up on to your right shoulder, still retaining hold of his right wrist with the left hand. Pass the right arm between the casualty's thighs, or round both thighs if it be a woman, and grip his right wrist with your right hand, at the same time removing your left hand which becomes free (see Fig. 42(c)). Shift the weight of the casualty well on to the centre of the back and rise to the erect position (see Fig. 42(d)).
- 12.12 *To lower to the ground an insensible person* being carried as above, withdraw the right arm from between the casualty's legs and pass it round the legs and, at the same time, grasp the casualty's right wrist with the left hand. Drop on to the left knee, swing the casualty's legs clear of your own across the front of your body and lower the casualty to a sitting position allowing your right hand to slide up his body to support the waist. Place your right arm behind the casualty's shoulders, remove the casualty's right arm from behind your neck and lower the casualty gently into a prone position, taking care that his head does not strike the ground.

#### *Rescue crawl*

- 12.13 If a rescuer finds an unconscious casualty, or one who is unable to help himself, or is too heavy for one of the above three methods to be applied, the rescue crawl can be used. The casualty is turned on his back and his wrists tied together. The rescuer kneels astride him facing his head and places his head through the loop thus formed by the casualty's arms. The rescuer by crawling on hands and knees can then drag the casualty with him, even though he may be heavier (see Fig. 43). It may



Fig. 42 (a). Fireman's lift



Fig. 42 (b). Fireman's lift



Fig. 42 (c). Fireman's lift



Fig. 42 (d). Fireman's lift

be necessary to support the casualty's head with one hand, or by placing a triangular bandage under the casualty's head and round the rescuer's neck, or by some other convenient method.

*Removal downstairs*

- 12.14** To remove the casualty downstairs he is laid on his back, head downwards on the stairs. The rescuer places his hands under the casualty's armpits so that his head rests on the crook of the rescuer's arm and he is eased gently downstairs (see Fig. 44).



Fig. 43. Rescue crawl



Fig. 44. Removal downstairs

## Methods of hand carriage suitable for more than one rescuer

### *Human crutch by two rescuers*

- 12.15** Where two rescuers are available they take up their positions, one on each side of the casualty. They place the casualty's arms round their shoulders and grasp his wrists with their outside hands. They pass their arms round the casualty's waist, grasping his clothing at the hip and thus assist him by acting as crutches. This method can be used for an unconscious casualty.



Fig. 45. Human crutch—two rescuers

### *The fore and aft method*

- 12.16** The casualty is placed on his back. One rescuer raises the casualty's shoulders and passes his hands under the arms from behind, clasping them in front of the chest. The other rescuer takes one leg under each arm and they carry the casualty feet first. If a leg is broken, both legs should be tied together, or put in splints, and both carried under one arm (see Fig. 46).
- 12.17** An alternative method of fore and aft carry is as follows. The casualty is placed on his back. One rescuer raises the shoulders and passes his hands beneath the armpits to grasp the flexed forearms of the casualty. The other rescuer passes one arm around both legs of the casualty and walks forward, keeping one arm free.

### *Two handed seat*

- 12.18** Two rescuers face one another on either side of the casualty and stoop. Each rescuer passes his arm nearest the casualty's head under the



Fig. 46. Fore and aft method

casualty's back just below the shoulders and, if possible, grips his clothing. They raise the casualty's back and slip their arms under the middle of his thighs, clasping their hands with a hook grip. The rescuers rise together and step off with short paces (broken step) (see Fig. 47 a-d).

NOTE: A rolled handkerchief should be placed between the locked hands when forming the hook grip.

#### *Three handed seat*

12.19 The two rescuers (Nos. 1 and 2) face each other on either side of the casualty and stoop. No. 1 grasps his own left wrist with his right hand, No. 2 grasps No. 1's right wrist with his right hand and No. 1 then grasps No. 2's right wrist with his left hand. No. 2 reaches across with his left arm and grasps No. 1's right arm just below the shoulder.

12.20 The casualty is seated on the hand seat and places his arms round the rescuers' necks. The rescuers rise together and step off with short paces (broken step). This method can be used for an unconscious casualty, the rescuers having to place the casualty's arms round their necks (see Fig. 48 (a) and (b)).

#### *Four handed seat*

12.21 The rescuers face each other and each grasp their own left wrist with their right hand. Their hands are then put together, the free left hand grasping the right wrist of the man opposite. The casualty puts one arm or both arms round the necks of the rescuers. The rescuers rise together and step off with short paces (broken step) (see Fig. 49 (a) and (b)).



Fig. 47 (a). Two handed seat



Fig. 47 (b). Two handed seat



Fig. 47 (c). Two handed seat



Fig. 47 (d). Two handed seat





Fig. 48 (a & b). Three handed seat



Fig. 49 (a). Four handed seat

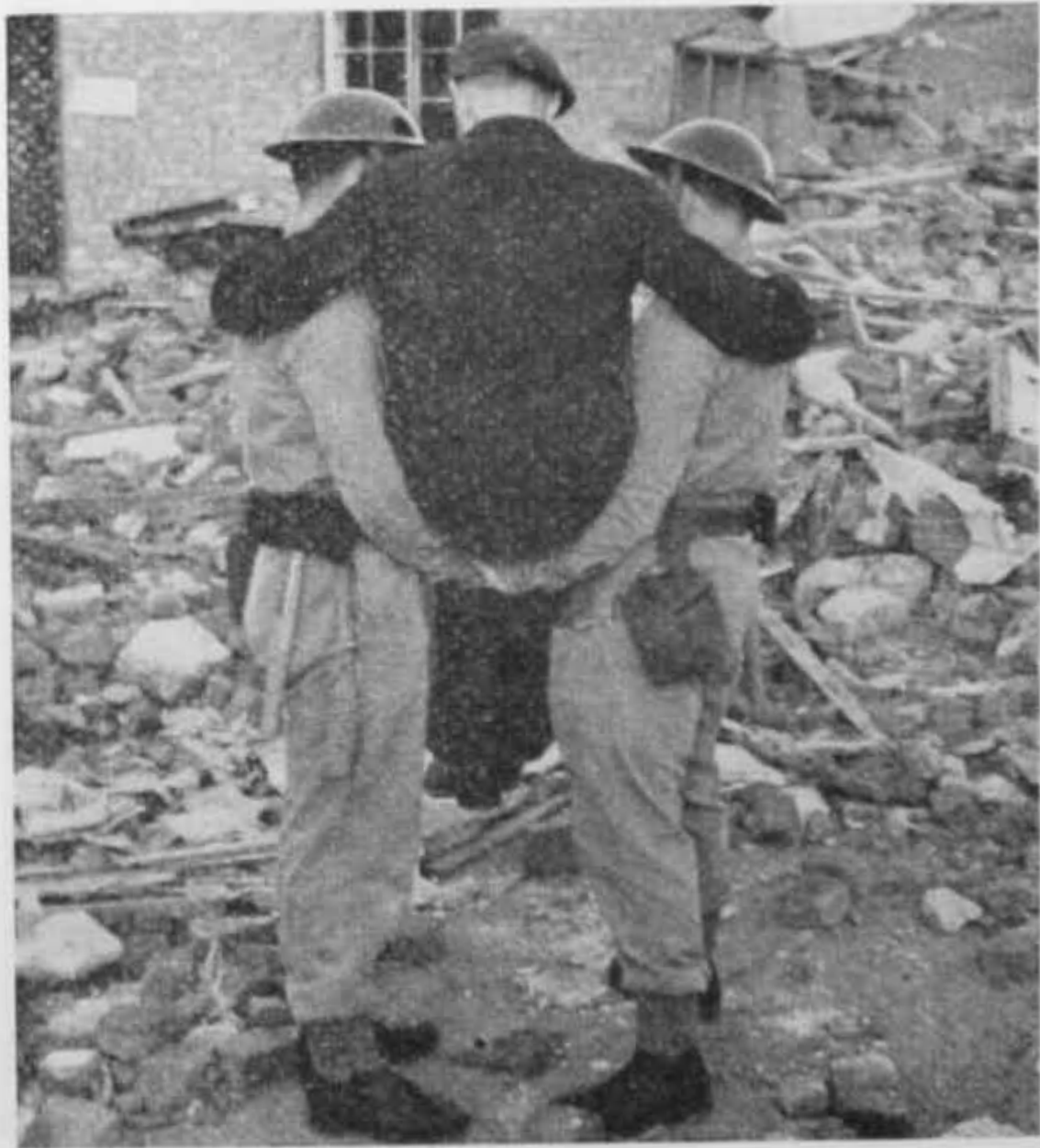

Fig. 49 (b). Four handed seat

## **Method for more than two rescuers**

### *Clothes lift*

- 12.22** The clothes lift should always be used in preference to lifting a casualty by his limbs. Taking up convenient positions beside the casualty, the rescuers stoop and take firm hold of his clothing in such a way that the weight of the casualty is evenly distributed between the rescuers when lifted.

### **Labelling casualties**

- 12.23** To assist with subsequent identification, a label should be attached to every serious or unconscious casualty, or body, stating the exact spot where the casualty or the body was found, etc. The reverse side of the label should indicate the nature of any special first aid treatment, e.g. crush injury, and the priority mark when required.

### **Confirming death**

- 12.24** Unless casualties (e.g. by reason of mutilation) are obviously dead they should be treated by rescue parties as alive until death is confirmed by a doctor. If there is no doctor available a Rescue Party Leader should take the responsibility of confirming death in clear cases but, whenever there is doubt, the casualty should be handed over to the Ambulance and Casualty Collecting Section (in Scotland, the Warden Section).

## CHAPTER 13

### Fibre Ropes

**13.1** The Rescue Section is supplied with fibre ropes of various sizes and also with steel wire ropes. The latter are dealt with in Chapter 27. They all require continual attention and care if their usefulness is to be maintained.

**13.2** Both fibre and wire ropes are made up of three or more strands twisted together. The size of manilla and other fibre ropes is denoted by the circumference of the rope in inches. Thus the two inch rope has a circumference of about two inches.

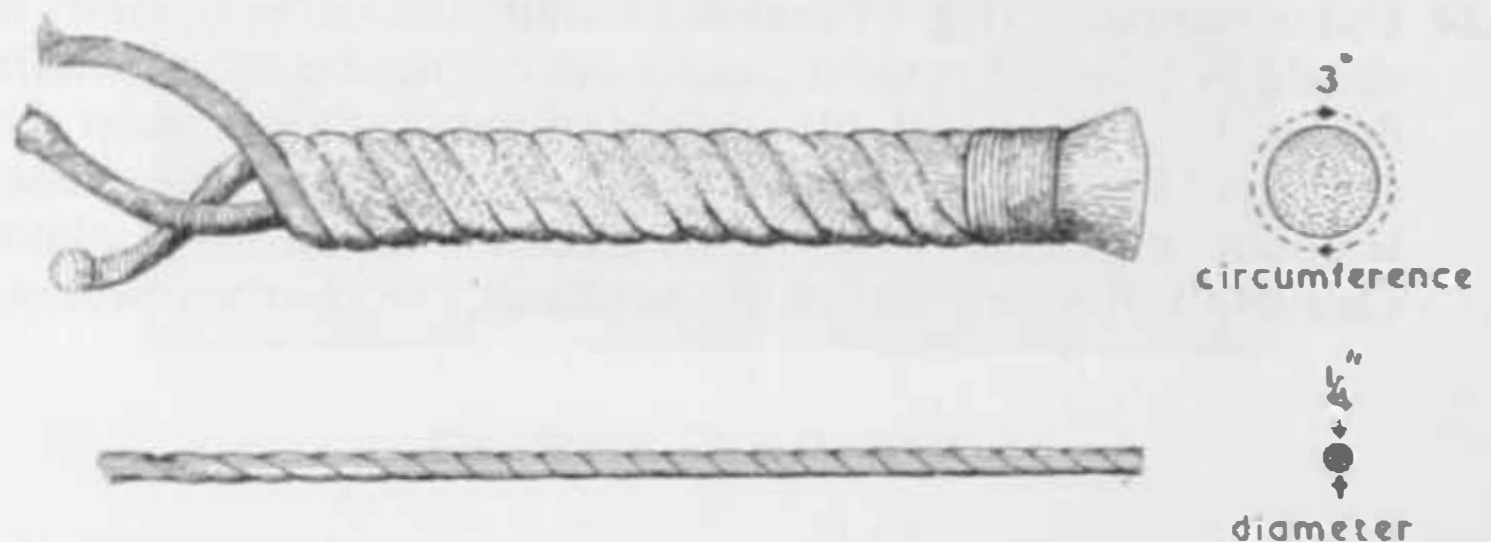

Fig. 50. Fibre and wire ropes

**13.3** Fibre ropes supplied for rescue work are "hawser laid", i.e. they have three strands, each consisting of a number of yarns, and the three strands are twisted together to form the rope. During manufacture they are adequately lubricated as an oil-base cream is essential for spinning the fibre into yarn, the amount of such lubricant being carefully restricted so that the finished rope will not be greasy. Apart from the manufacturing necessity, this lubricant has beneficial and preservative effects upon the finished rope as it reduces friction between fibres, yarn and strands and renders the rope pliable and easy to use.

#### Importance of care and upkeep

**13.4** Members of the Rescue Section must be made to realise the importance of upkeep and care of the ropes in their charge. If they are not kept in good condition and used with care they will not be sound and thoroughly efficient for rescue work. It must always be remembered that lives may depend on the condition of the ropes used in rescue work. Fibre ropes are liable to damage in a variety of ways and too much care cannot therefore be taken in their handling, inspection and storage.

#### Uncoiling a new rope

**13.5** It is not usual for ropes to be supplied to the Rescue Section in large coils, but in the event of this happening it must be remembered that

there is a right and a wrong way of dealing with the coil when removing the rope from it for cutting into the required lengths.

- 13.6 To take a length of rope from a large coil, lay the coil on one end so that the end of the rope in the centre of the coil is at the bottom; loosen any bands which may be fastening the coil, reach down through the centre and draw the end of the rope upwards, uncoiling it in an anti-clockwise direction. The rope thus drawn out can then be cut to the required length after which the ends must be whipped to prevent fraying.

#### **Possible sources of damage**

- 13.7 Rescue work is often carried out under difficult conditions and where there is considerable debris, and unless care is taken, ropes may well be damaged beyond use, or their effective life may be shortened and dangers may arise to those using the ropes or to casualties being rescued.

#### *Damage from rough surfaces*

- 13.8 In rescue work it is often necessary to use a rope over a window sill, etc., and unless care is taken to protect the rope from the sharp edge of the sill by packing with sacking or similar material or rounded timber it can easily be damaged, as any rough or sharp edge will chafe the outer fibres of the strands and rapidly reduce the strength of the rope. Grit or dirt picked up by the rope may work its way between the strands and so cause internal damage which is not readily seen.

#### *Wet*

- 13.9 When rescue work has to be done in wet weather the ropes in use become saturated with water. If they are left lying while in this state, or stowed away while still wet or even damp, they are liable to be affected by rot. They should be dried out as soon as possible by hanging them over a spar, or better still by spreading them on a ladder set horizontally off the floor of a room in which there is a good circulation of air, and so arranging them that the air can pass freely over them. Before returning them to manpacks, vehicles or into store, they should be examined to see that they are clean and dry.

#### *Extra heat and cold*

- 13.10 Exposure to extremely cold weather, very hot sunshine or direct heat can cause damage to fibre ropes. Freezing renders the fibres brittle and the ropes may break without warning. Frozen ropes must be thawed out slowly by hanging them up in a moderately heated room. When ropes are subjected to direct heat the natural oil from the fibres may also be removed causing the ropes to become brittle and break easily.

#### *Chemical action*

- 13.11 If ropes have been in contact with acids or chemicals, inspection by a competent person is essential as deterioration through contact with certain chemicals and acids may be very rapid. Such ropes should immediately be taken out of use, and stored away from all other ropes until the inspection has been made.

### *Undue strain*

- 13.12 Ropes used for hauling or lifting may be damaged when subjected to too heavy a load or by sudden jerks on the rope which set up violent stresses within the fibre.

### *Safe working load*

- 13.13 As a rough guide, the safe working load of a new, dry, fibre rope in cwts. can be taken as its circumference (in inches) squared.

Example: To find the safe working load of a 2 in. fibre rope—  
 $2 \text{ in.} \times 2 \text{ in.} = 4 \text{ cwts. safe working load.}$

The strength of a rope is greatly reduced when it is wet, when knots have been left in it and when it has been in use for a considerable number of times and the fibres may have become strained or damaged. Only a thorough examination can gauge the wear and tear on the rope or the loss of strength in the fibre by deterioration.

### *Stretching a new rope*

- 13.14 New rope must be stretched before putting it into use. This can be done by using a snatch block. Attach the hook of the block securely to a strong holdfast, reeve one end of the rope round the pulley and fasten off to itself with two half-hitches. The rope can then be run out and if the weight of two men is slowly applied to it the fibres will be gently straightened. As the hook of the block is on a swivel, any twist in the fibres will automatically be adjusted by the block being able to rotate.

### *Inspection of fibre ropes*

- 13.15 Fibre ropes must be examined regularly whether in use or in store, and especially if there is reason to believe that any rope which has been in use has been subjected to harsh treatment or undue strain. Commencing at one end, the rope should be examined throughout its entire length for signs of wear and to determine whether it needs replacement. Look for such signs of wear as chafing of the crowns and of the strands, and broken or frayed yarns.
- 13.16 A rope which may appear perfectly sound externally may have been subjected to severe internal wear by grit or dirt which has worked its way between the fibres and caused internal damage; this can often be detected on examination by noting the presence of grit between the strands, in which case the pieces of grit should be carefully picked out with a splinter of wood. On no account should a knife or other metal object be used to remove grit, or further damage may be caused. In some cases where the grit has worked its way out of sight, powdered fibre from the inner side of the strands may be found, thus directing attention to the fact that there is likely to be internal damage.
- 13.17 Rot and mildew are detected by the presence of coloured stains and an unpleasant smell. Mildew is a fatal cause of deterioration and in some cases its presence can be detected only by the most careful examination. It is caused by "moulds" which render the fibres weak and unable to stand up to normal strains.

- 13.18 If ropes have picked up oil during use, they should be cleaned with soap and warm water, then thoroughly rinsed and dried.
- 13.19 Any ropes considered defective should be labelled and placed in store, away from ropes in good condition, until they can be examined by a competent person.

### Storage of fibre ropes

- 13.20 Fibre ropes in store must be protected from dampness or heat, and it is advantageous to hang them on wooden pegs or galvanised iron hooks in a well ventilated store so that air can freely circulate around them. The ideal temperature for a room in which ropes are stored is from 50 degrees to 70 degrees F. but not exceeding the latter, and with efficient ventilation. In some cases it may be found more suitable to erect racking, with open spaces between the slats to ensure thorough circulation of air. The place selected for storage should not contain, or have had stored in it at any time, acids, alkalis, or paints or any materials containing alkalis or acids, as all of these are detrimental to the life of fibre ropes. If there is a possibility of rats or mice in the vicinity of the store, steps must be taken to keep them out as they will attack the ropes especially when nesting. Care must always be taken to ensure that rope which has been used is clean and dry before it is coiled up and put away in the store.

### Whipping a rope

- 13.21 Avoid cutting a rope unless it is essential to do so. If it is necessary, ensure that the cut end is whipped as soon as possible, preferably with waxed twine, to prevent fraying. As a temporary measure to prevent fraying, tie a figure of eight knot near the end of the rope.

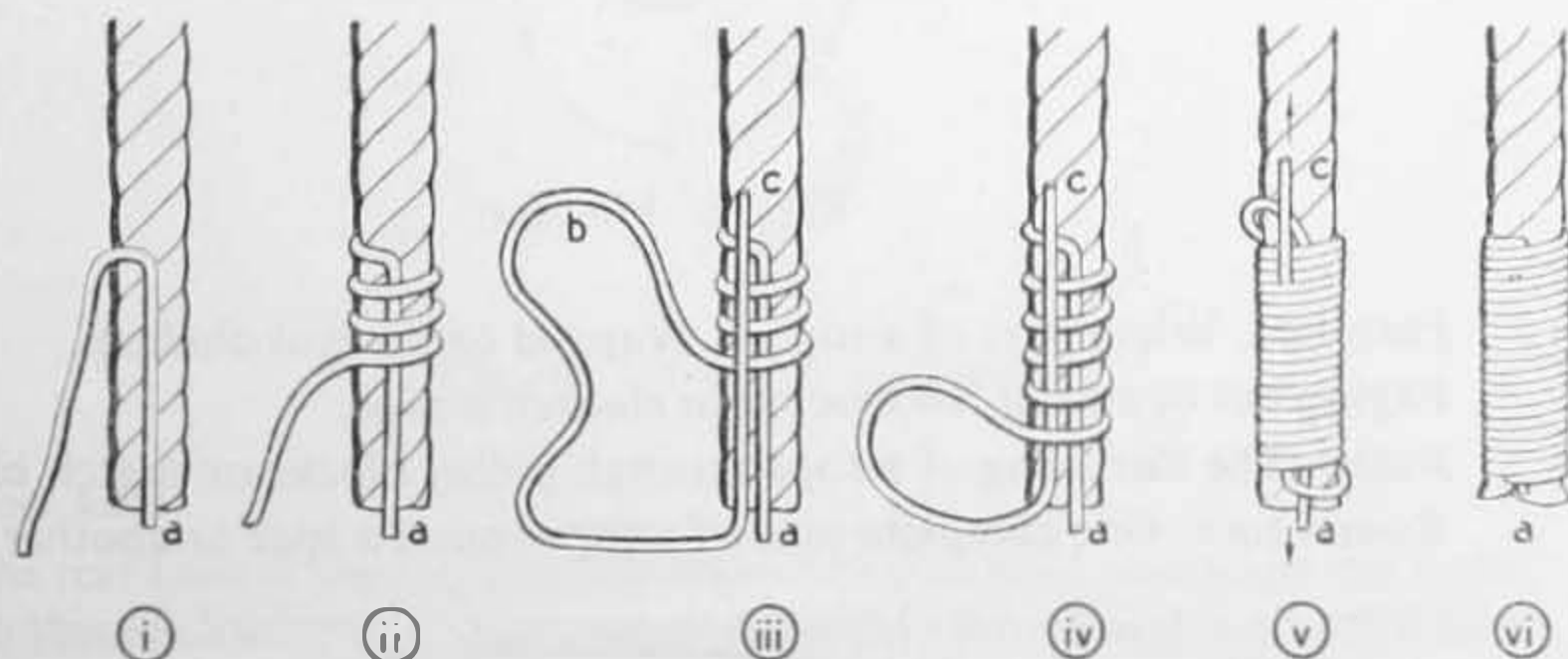

Fig. 51. Whipping the end of a rope

### Terms used in connection with ropes

- 13.22 Anchored. Fastened to some immovable object, such as a large tree, post or a well-driven picket.

Bight. An open loop in a rope.

Frapping. The binding together of a lashing between two poles.

Haul. The act of pulling on a rope.

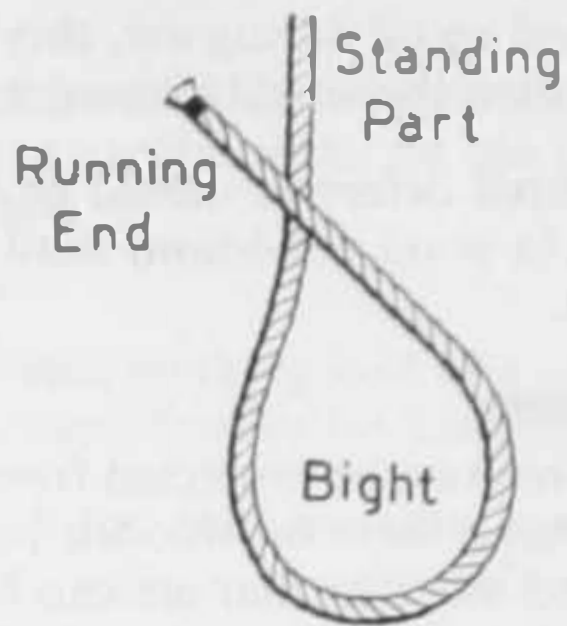

Fig. 52. A bight

**Hitch.** A closed loop on a rope; a simple fastening of a rope around some object by winding and crossing one turn over another turn so that one bites on the other without actually knotting the rope.

**Mousing.** Tying a piece of cord across the jaws of a hook to prevent a rope or sling from jumping out when the weight is temporarily supported.

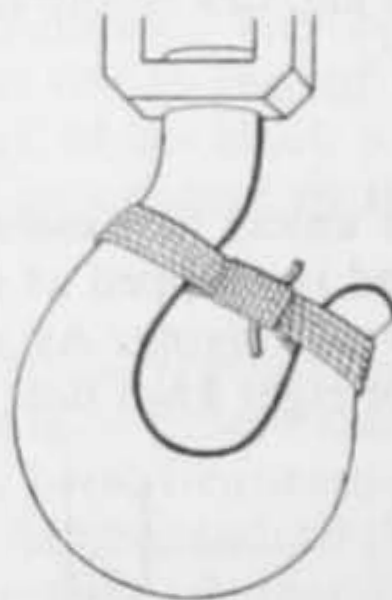

Fig. 53. Mousing

**Parcelled.** When part of a rope is wrapped to prevent chafing.

**Paying out or easing.** To ease off or slacken a rope.

**Reeve.** The threading of a rope through pulley blocks or snatch blocks.

**Round turn.** One complete turn of a rope round a spar or another rope.

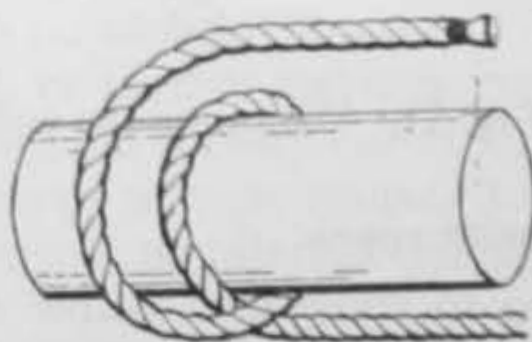

Fig. 54. Round turn

**Running end.** The free end of a rope.

**Standing part.** The part of the rope which is taking the load.



## CHAPTER 14

### Knots and Lashings

**14.1** Rescue Section personnel should be familiar with the following knots, and by constant practice must learn how to adapt them with speed and proficiency. Knots must always be tied tightly.

#### Figure of eight knot

**14.2** With the rope "away" from you, take the standing part in the left hand, palm upwards, and the running end in the right hand. Pass the running end over the top of the standing part making a loop, then carry on with the running end round behind the standing part, over the top, then down through the loop which you have formed. Draw the running end tight and the knot should resemble the figure-of-eight (see Fig. 55). It should be used temporarily to prevent the end of a rope from fraying when the whipping has been lost, or to check a rope from running through a pulley block.



Fig. 55. Figure of eight knot

#### Reef knot

**14.3** The reef knot is used to join two ropes of equal thickness when the strain on them is likely to be constant. It is quickly untied and is a useful knot for general purposes. Take running ends of ropes, one in each hand, pass end in right hand over that in left hand and tie single knot, then pass end in left hand over that in right hand and tie another single knot. The ends when pulled tight will be parallel with the turns of the ropes. The rule for tying a reef knot is right over left, and left over right (see Fig. 56).

#### Sheet bends

**14.4** There are two types of sheet bend, the single sheet bend and the double sheet bend. Both are used for uniting two ropes of different thicknesses,

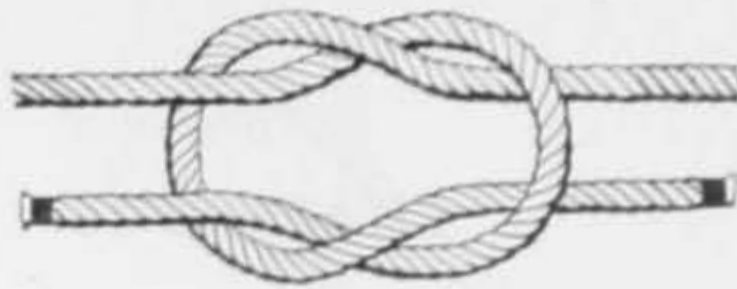

Fig. 56. Reef knot

or when ropes are wet or when the strain on the rope is likely to be variable: e.g. in a rope used as a guy line. The double sheet bend is more secure and should always be used in rescue work. To form a double

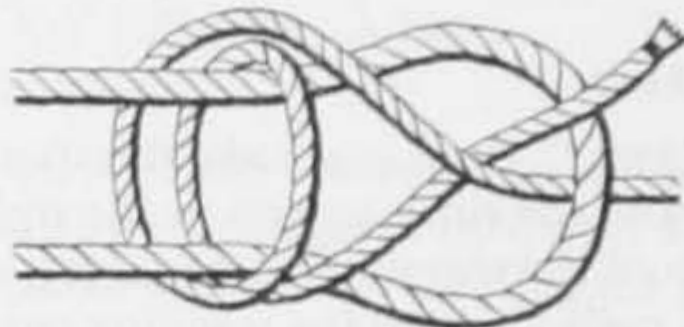

Fig. 57. Double sheet bend

sheet bend, make a loop in the thicker of the two ropes, hold this in the left hand, and pass the end of the thinner rope upwards through the loop to form a half hitch round the two thicknesses of the thicker rope. Continue turning its short end to make another round turn around the two thicknesses of the thick rope and towards the bight (see Fig. 57).

#### Clove hitch

- 14.5 This forms the basis of many securing knots and can be used in the end of a rope or in the centre. (a) To tie at the end of a rope, pass the running end round a pole bringing it out underneath the standing rope. Pass the running end round the pole again above the first half hitch, bringing the running end under itself. To tighten, pull both the running end and the standing rope. When tied thus in the end of a rope, it is a good anchoring knot and is easily untied. (b) To tie in the centre of a rope, two loops are formed, one in the left hand (anti-clockwise) and one in the right hand (anti-clockwise) the latter being passed in front of the left hand loop. Both loops are then passed over the spar and drawn tight (see Fig. 58).

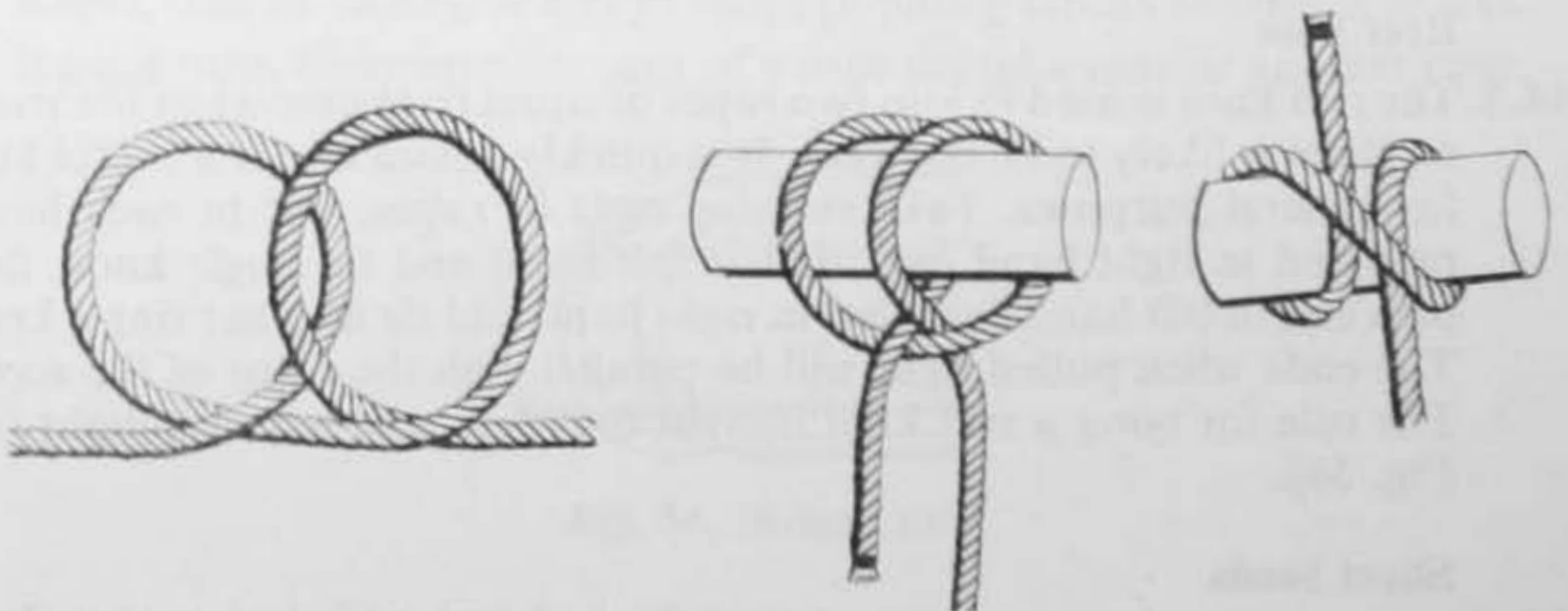

Fig. 58. Method of making a clove hitch. Left and centre: by means of two locking half-hitches slipped over an object or spar. Right: on a rope or spar

## Bowline

- 14.6** This forms a non-slip loop at the end of a rope and is a most useful anchoring knot. It may also be used for lowering or raising purposes and for attaching a rope to a person as a safety line. To tie this knot take the running end of the rope in the right hand, pull it across the upturned palm of the left hand and lasso the fingers of that hand, making sure that the loose end of the rope will make a loop of the required size. Next, pass the running end (still held in the right hand) up through the loop, then underneath the standing rope and back downwards through the loop. To tighten, pull the standing rope and running end (see Fig. 59).



Fig. 59. Bowline

## Chair knot

- 14.7** This knot is a good general purpose knot and one which is very important for emergency rescue work. Its purpose is to form an efficient and quickly made sling in which a person may readily be raised or lowered. The sling formed by this knot gives support to the chest and legs of the person being rescued.
- 14.8** The chair knot is formed by grasping the rope, near its centre, in the left hand, palm down. Approximately a yard from the left hand take the rope in the right hand, palm uppermost. Turn the left hand palm upwards forming a loop (anti-clockwise), turn the right hand palm down forming a loop, bring the loops together, then pass the standing ropes through the loops of the opposite hand pulling them through thus forming two loops with a knot in the centre. These loops can be adjusted to the required size. A half-hitch is then made on each loop to keep them at their required size. One loop will be slightly larger than the other to keep the person being raised or lowered in a "chaired" position (see Fig. 60).
- 14.9** To place the person properly in the knot, the small loop must go under the armpits, and the longer loop at the back of the knees. When properly fixed in this knot and slung, the person cannot get out however much he may struggle. At the same time no undue pressure is caused upon his body. The chair knot may also be used as a stretcher sling, made by forming a chair knot complete with half hitches, in the centre of a 40 ft. lashing. The sling is attached to the stretcher handles by means of half

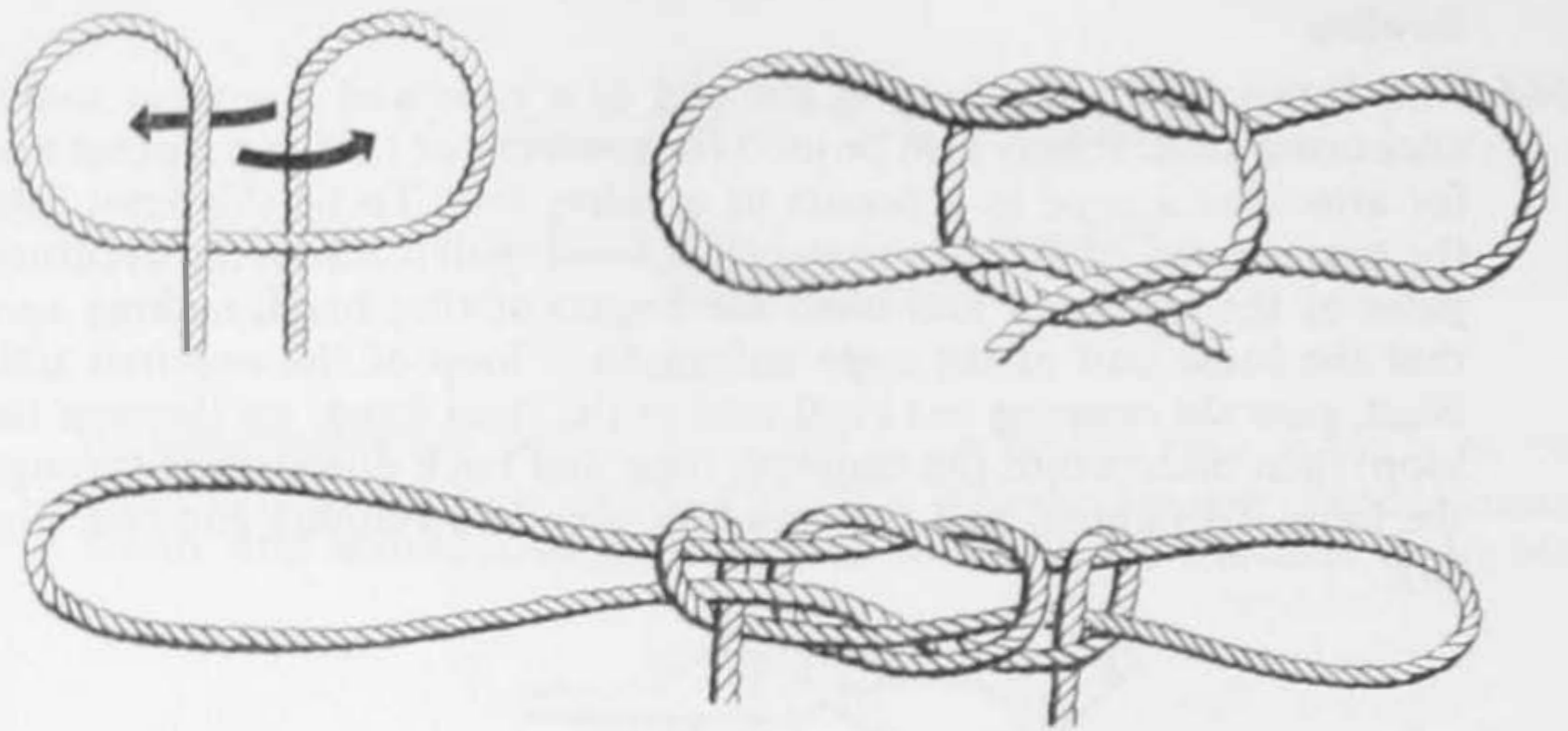

Fig. 60. Method of making a chair knot

hitches and adjusted. The point of balance is found and using the ends of the 40 ft. lashing an eye is formed and secured by means of a clove hitch. The 2-in. rope is passed through this eye and attached by forming a bowline. This method is used when a casualty has to be removed in a horizontal position.

#### Round turn and two half hitches

- 14.10 This also is used for securing a rope to a spar (or holdfast) and is formed by a round turn on the spar (or holdfast) with two half hitches on the rope.

#### Timber hitch

- 14.11 This is a quickly made knot used to secure a rope to a plank, spar or pole, and is formed by making a half hitch on the rope, leaving a long end which is twisted back again and given a minimum of three turns around its own part of the hitch. When used for lifting spars, planks or poles, this hitch should be used in conjunction with a half hitch at the upper end of the spar in order to keep the spar, etc., reasonably upright and prevent it catching on obstructions.

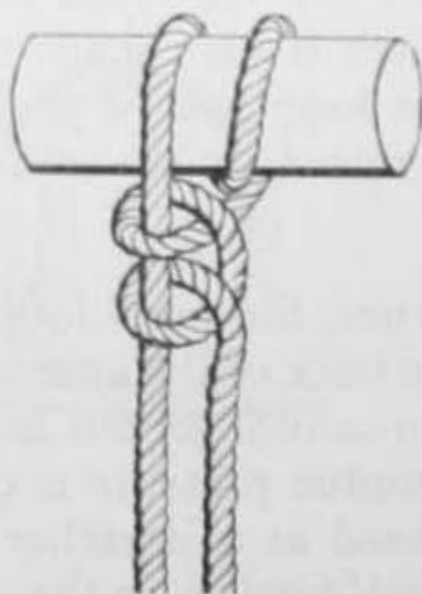

Fig. 61. Round turn and two half hitches

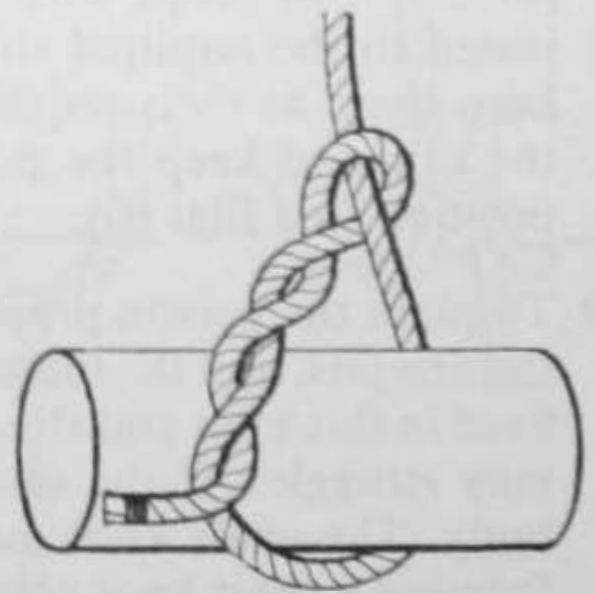

Fig. 62. Timber hitch

## Draw hitch

- 14.12 The draw hitch is reliable on a round spar or ring, but not on any square or angular object. It will hold a strain on the standing end and can be released by jerking the free end. It enables the rope to be recovered from places where the knot cannot be reached and untied by hand.
- 14.13 A bight is made in the rope as shown in (a), and a second bight which is then formed as shown in (b) is passed through the first bight (c). A third bight is formed on the other part of the rope (d) and passed through the second bight and the whole tightened up. NOTE: The bights should be tightened as much as possible at each stage.

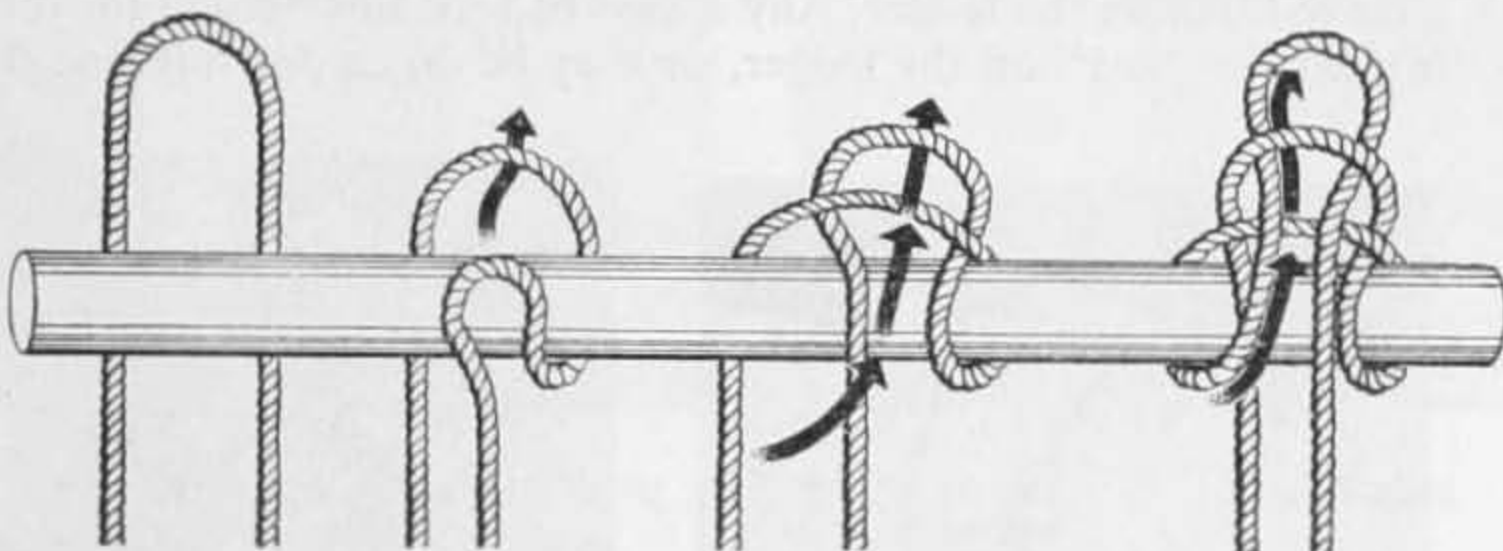

Fig. 63. Draw hitch

## How to throw a line

- 14.14 It may be necessary in rescue operations to throw a line quickly and accurately to another person whilst retaining one end of the rope; for example, across a gap from one building to another, or from ground to first or second floor level. The best way of doing this is to coil the line clockwise in the left hand from the standing end to the running end, thus taking out all kinks; hold the main part of the coil loosely in the left hand, take two or three coils in the right hand, then swing and throw them underarm, letting the line run off the left hand. If one end of the line is not made fast, hold it in the left hand and hang the coil on the wrist.

## Lashing

- 14.15 Lashing is the term applied to the act of securing one object to another, such as a spar to another spar, or a pulley block to a spar. Whenever possible wire bonds should be used as they remain tight whereas cordage lashings are liable to become loose. Both wire and rope lashings are, however, made in a similar manner. When making lashings, the spars should be raised above the ground on some sort of support to enable the operator to pass the rope under or between them. The 40 foot  $1\frac{1}{2}$  inch lashing lines carried should be used for the lashings described below.

### *Square lashing*

- 14.16 One often employed is the square lashing, used to lash together two spars or timbers that touch and cross at right angles. The example shown in Fig. 64 is the commencement of the square lashing as applied

to the attachment of a cross head on a single derrick. The square lashing is started with a clove hitch round the spar below the cross head or ledger, twisting or marrying the running end round the rope before taking these married ends up and around both the spar and the ledger. Repeat the circuit of the pole and ledger three or four times drawing the rope as taut as possible. Make three or four frapping turns around the whole lashing between the spar and ledger, draw taut and finish off with a clove hitch. Frapping turns are turns of a lashing taken round other turns of the same lashing in order to make them tight.

- 14.17 Fig. 65 shows the completed square lashing. Note the finishing off with a clove hitch on the ledger. Any excess of rope not needed for this lashing can be "lost" on the ledger, or may be taken down beside the spar

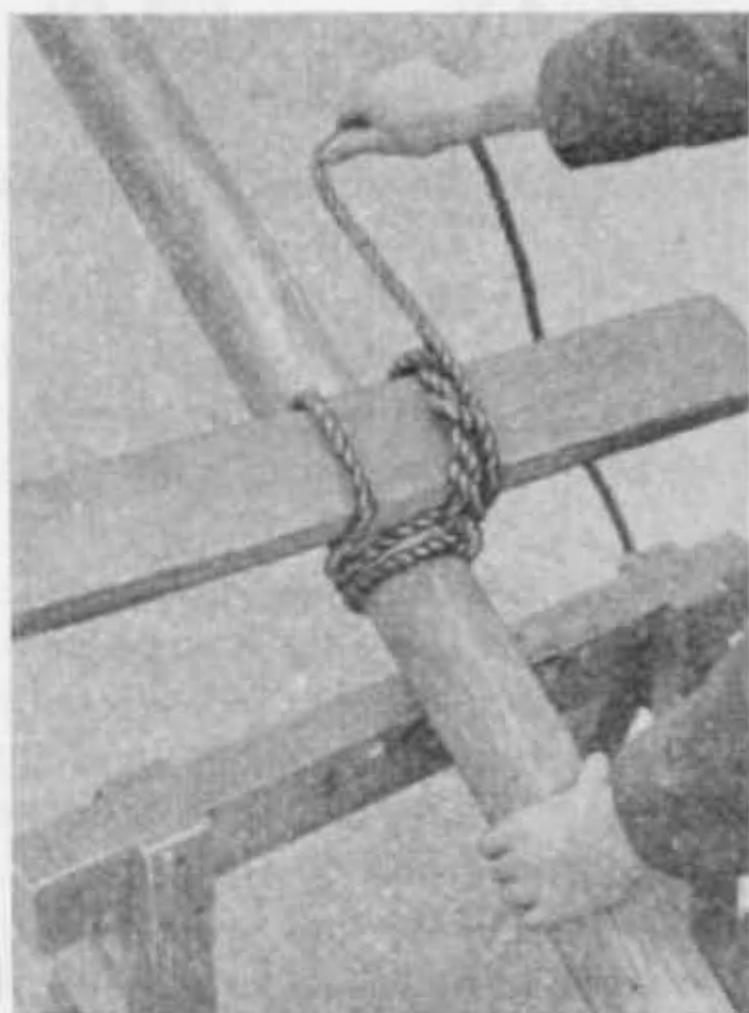

Fig. 64. Start of a square lashing

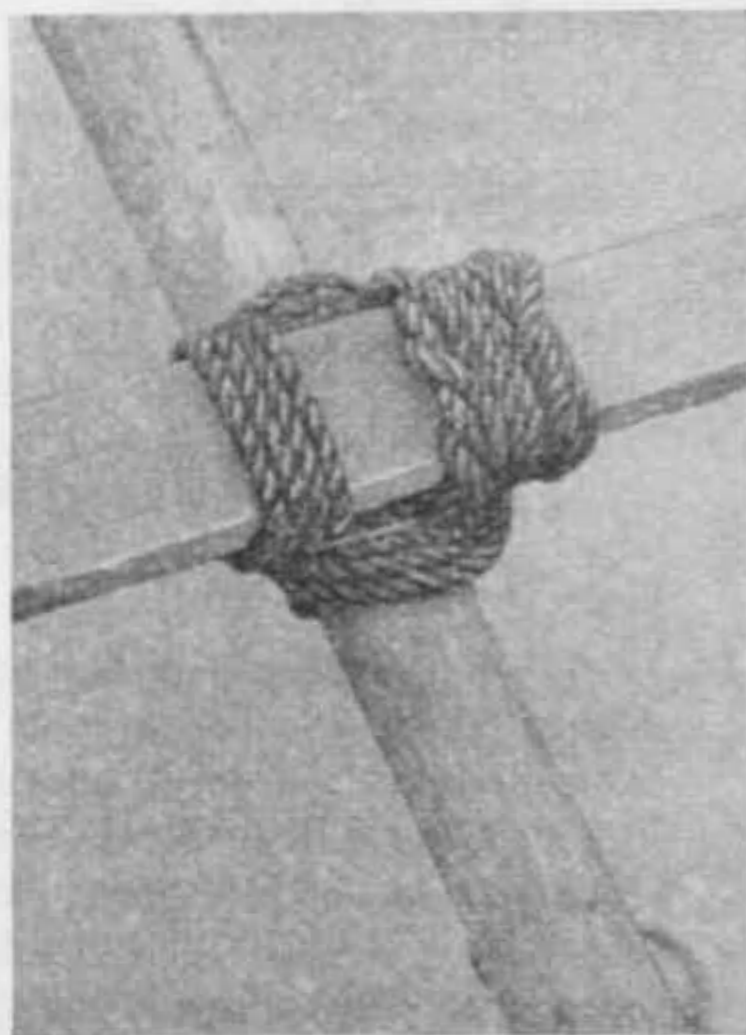

Fig. 65. Completed square lashing

and used to lash the lifting equipment temporarily to the pole while the derrick is being raised.

#### *Diagonal lashing*

- 14.18 Diagonal lashing is used to lash together two spars touching at an angle, especially when their mode of use may cause them to spring apart. To make a diagonal lashing, support the spars above ground and start with a timber hitch around both spars horizontally (Fig. 66 (a)). Then make four vertical turns between the spars and draw taut (Fig. 66 (b)). Then take four horizontal turns around the spars and draw taut (Fig. 66(c)). And finally put four frapping turns over the lashing between the spars and draw well taut, finishing off with a clove hitch (Fig. 66 (d)).

#### *Round lashing*

- 14.19 This is used to lash two or more spars together to strengthen them for use as a derrick, or when suitably spaced and frapped, for lashing two spars together for subsequent crossing and use as sheer legs.

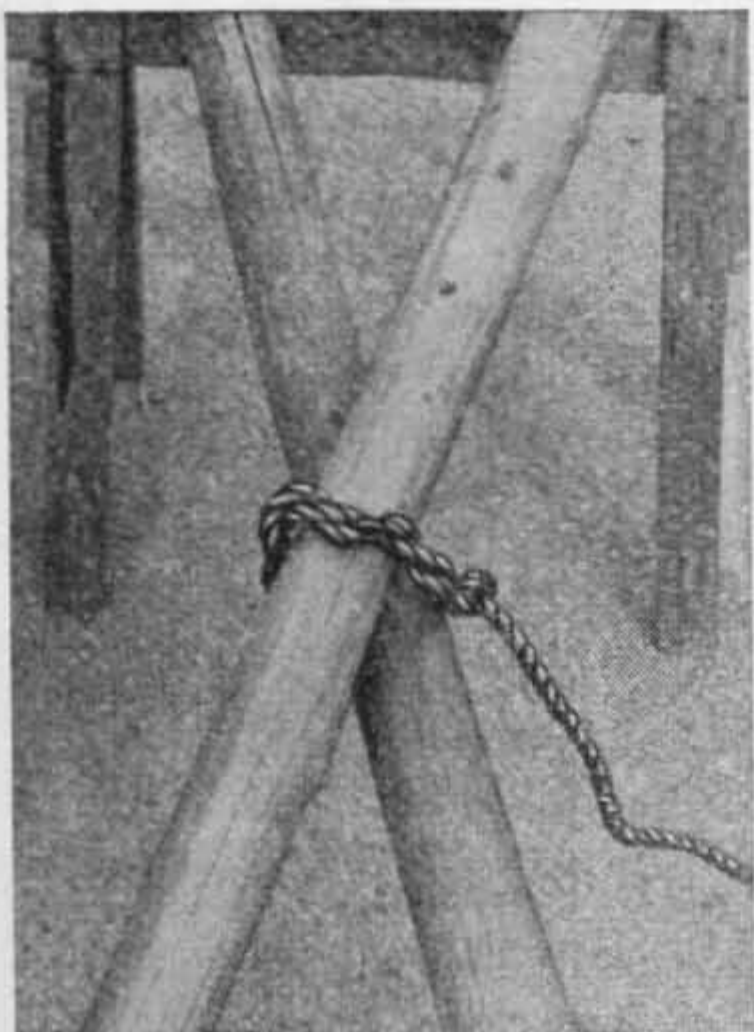

Fig. 66 (a). Diagonal lashing

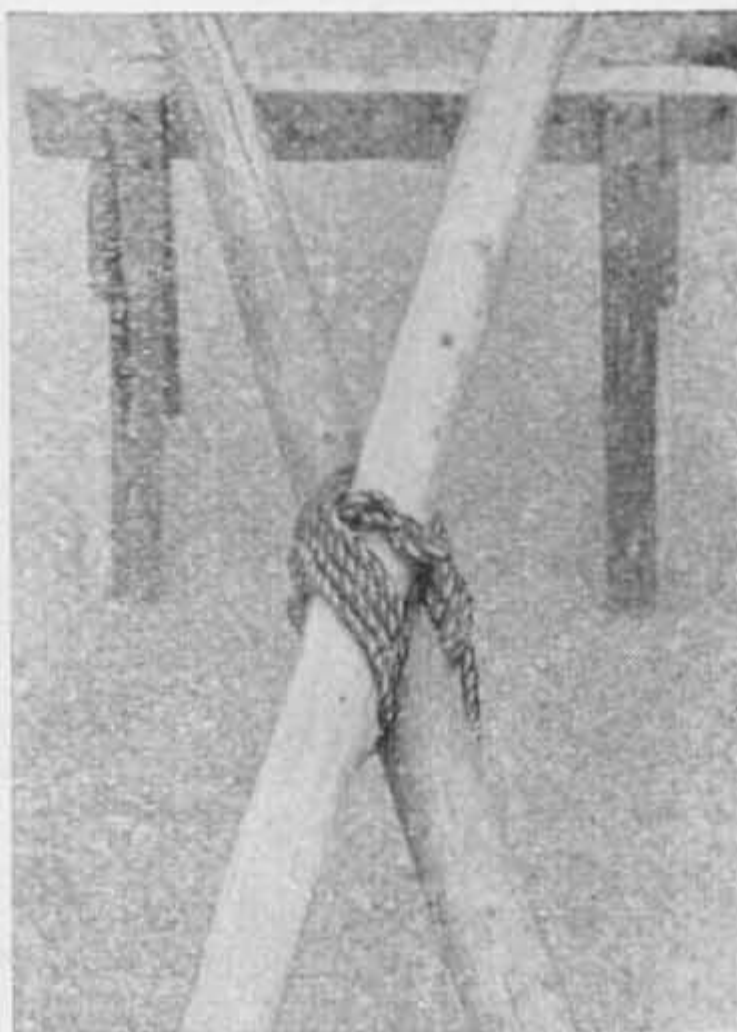

Fig. 66 (b). Diagonal lashing

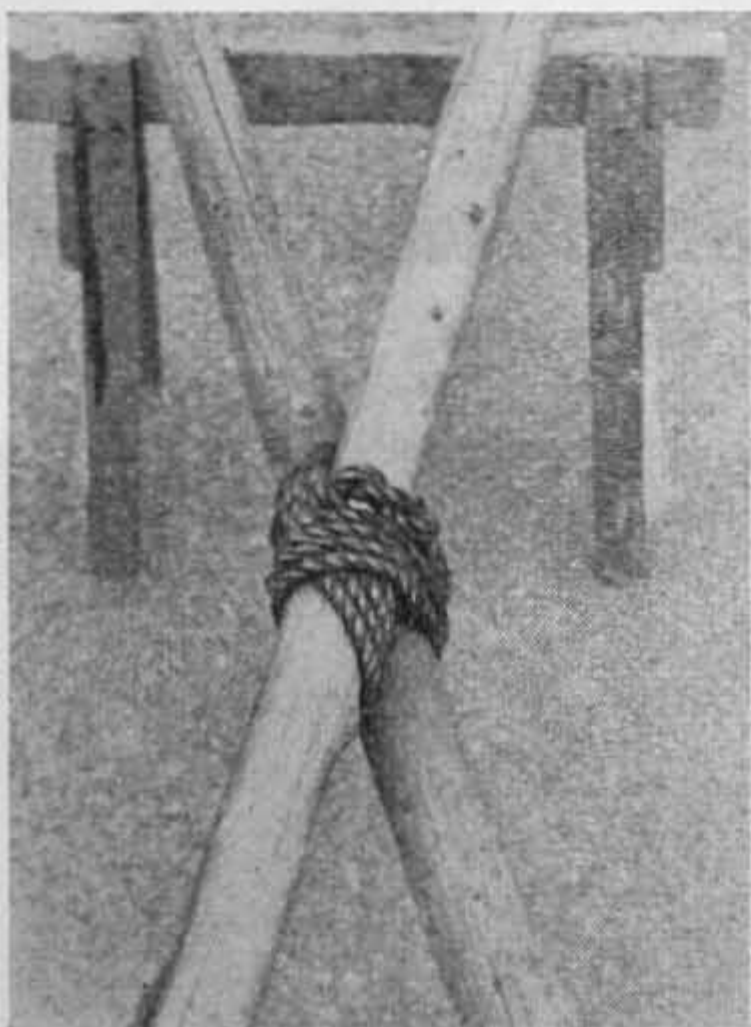

Fig. 66 (c). Diagonal lashing

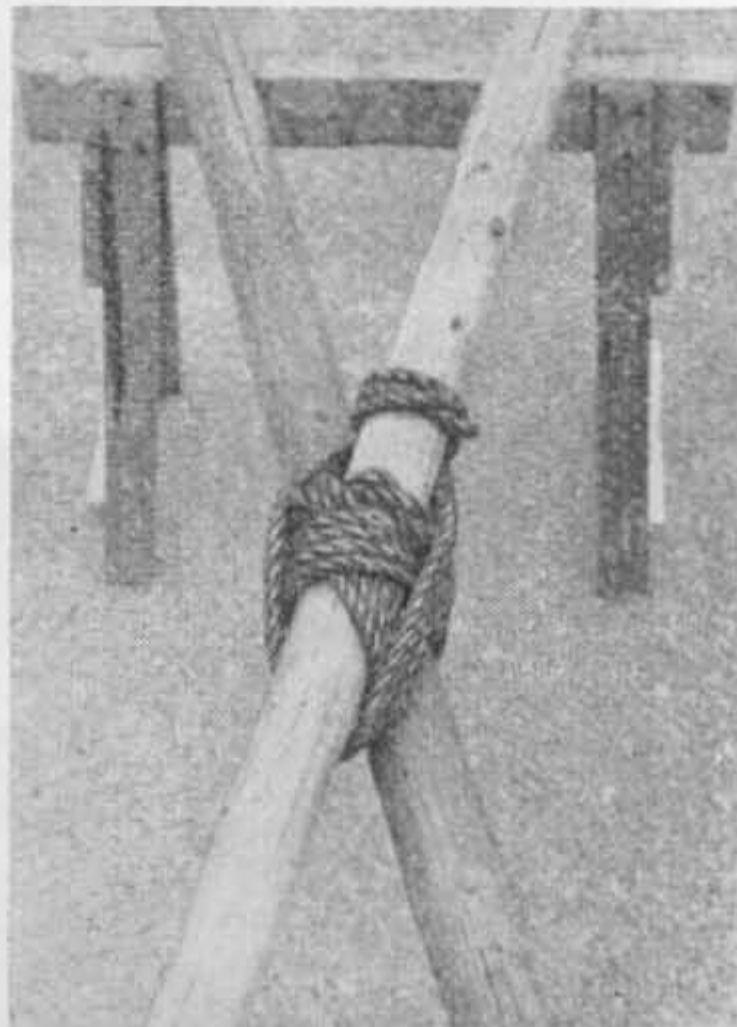

Fig. 66 (d). Diagonal lashing

**14.20** The example shown in Fig. 67 is a round lashing for use with sheer legs. Support the spars off the ground and insert a packing piece or pieces between them to keep them apart during the lashing process. These packing pieces should be 2 to 3 inches wide. Make a clove hitch on one spar and twist or marry the running end of the rope as shown. (Fig. 67 (a)). Take six or eight close turns around both spars above the clove hitch travelling towards the top of the spars (Fig. 67 (b)). Make two or three frapping turns round the lashing in the space between the spars formed by the packing pieces and finish off with a clove hitch above

the lashing. Lose any remaining rope on one of the spars, or take it down one spar where it could be available for temporarily lashing the lifting equipment to the spar during the raising of the sheer legs. Fig. 67 (c)).

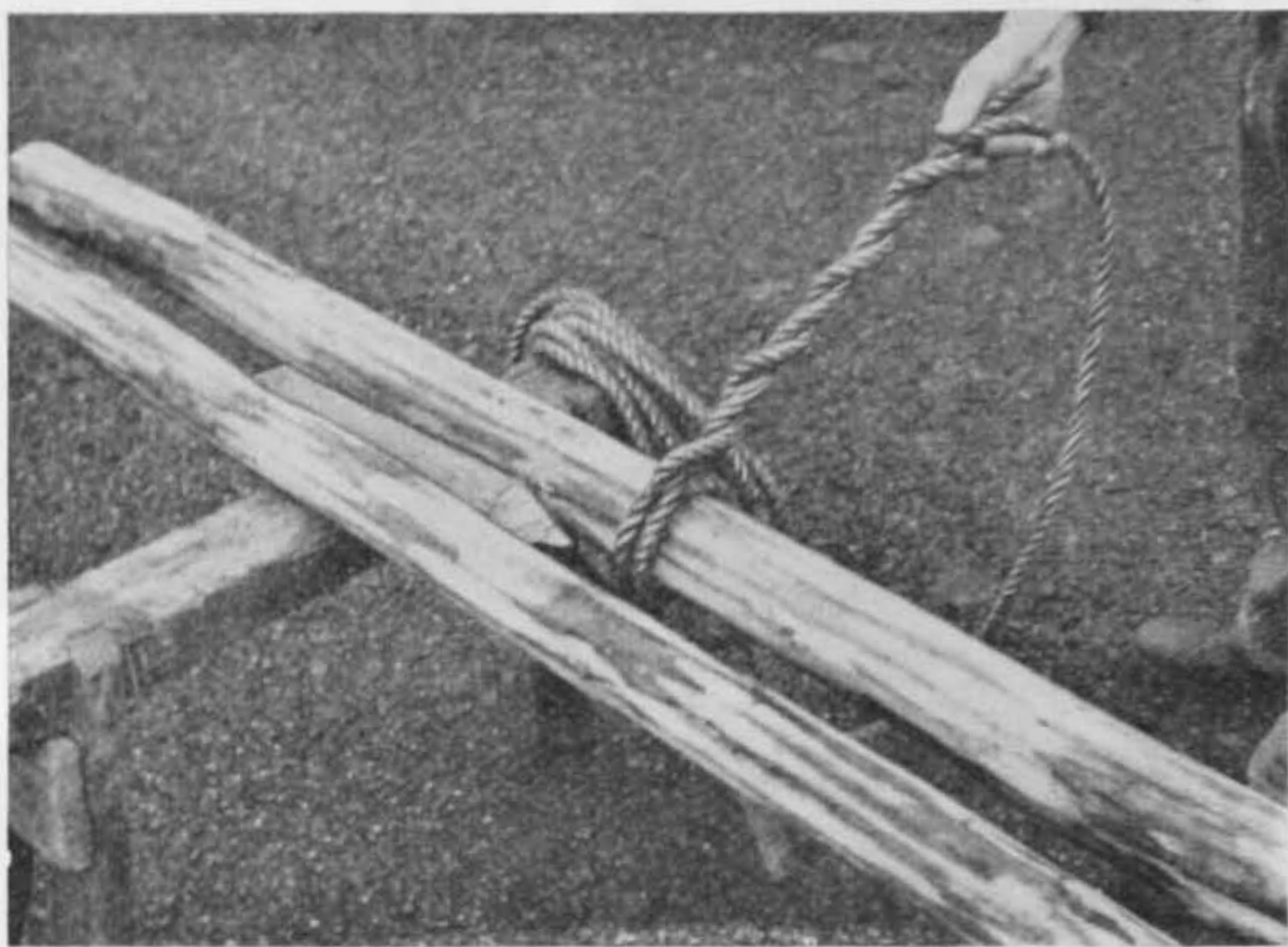

Fig. 67 (a). Round lashing

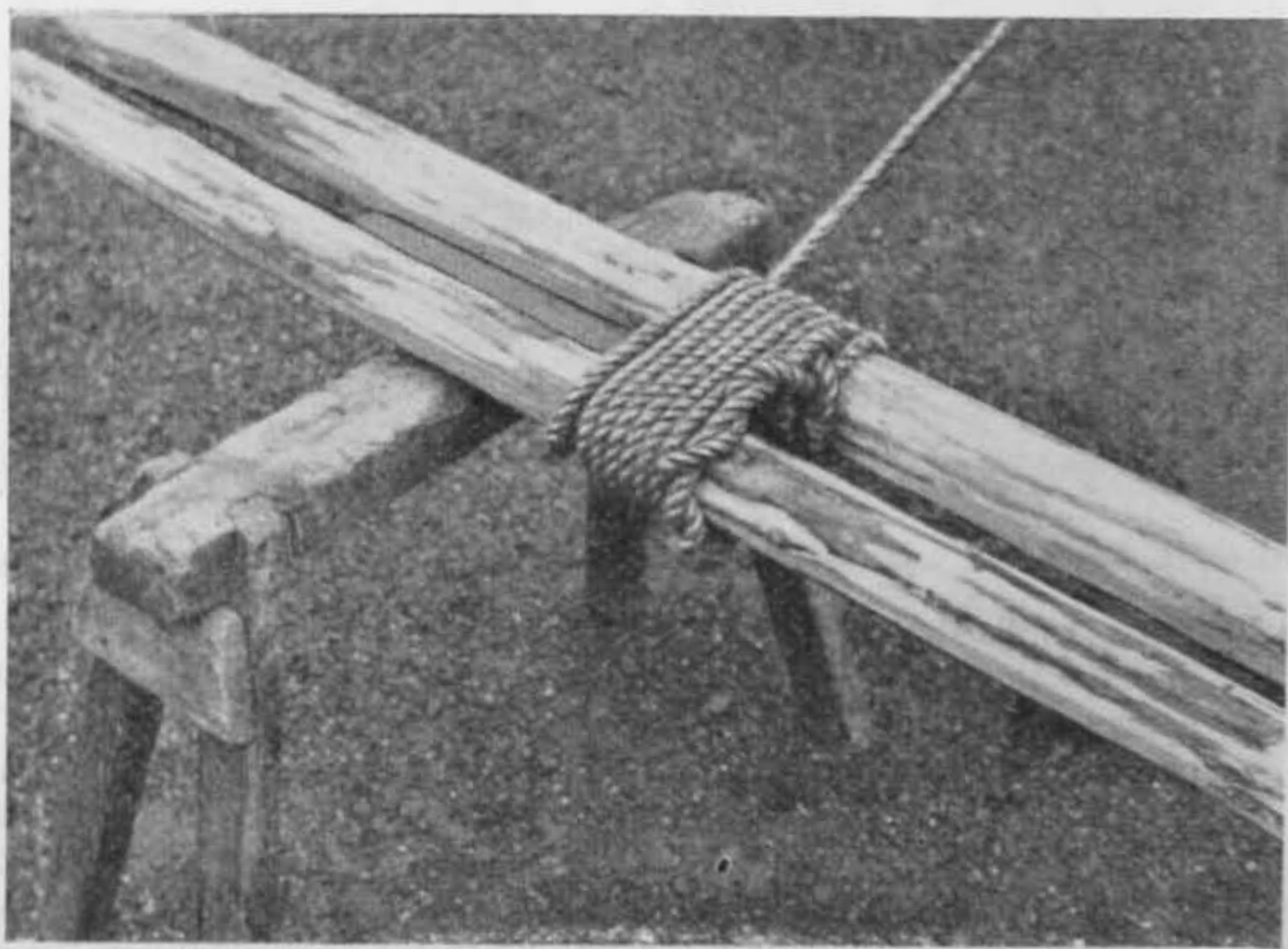

Fig. 67 (b). Round lashing



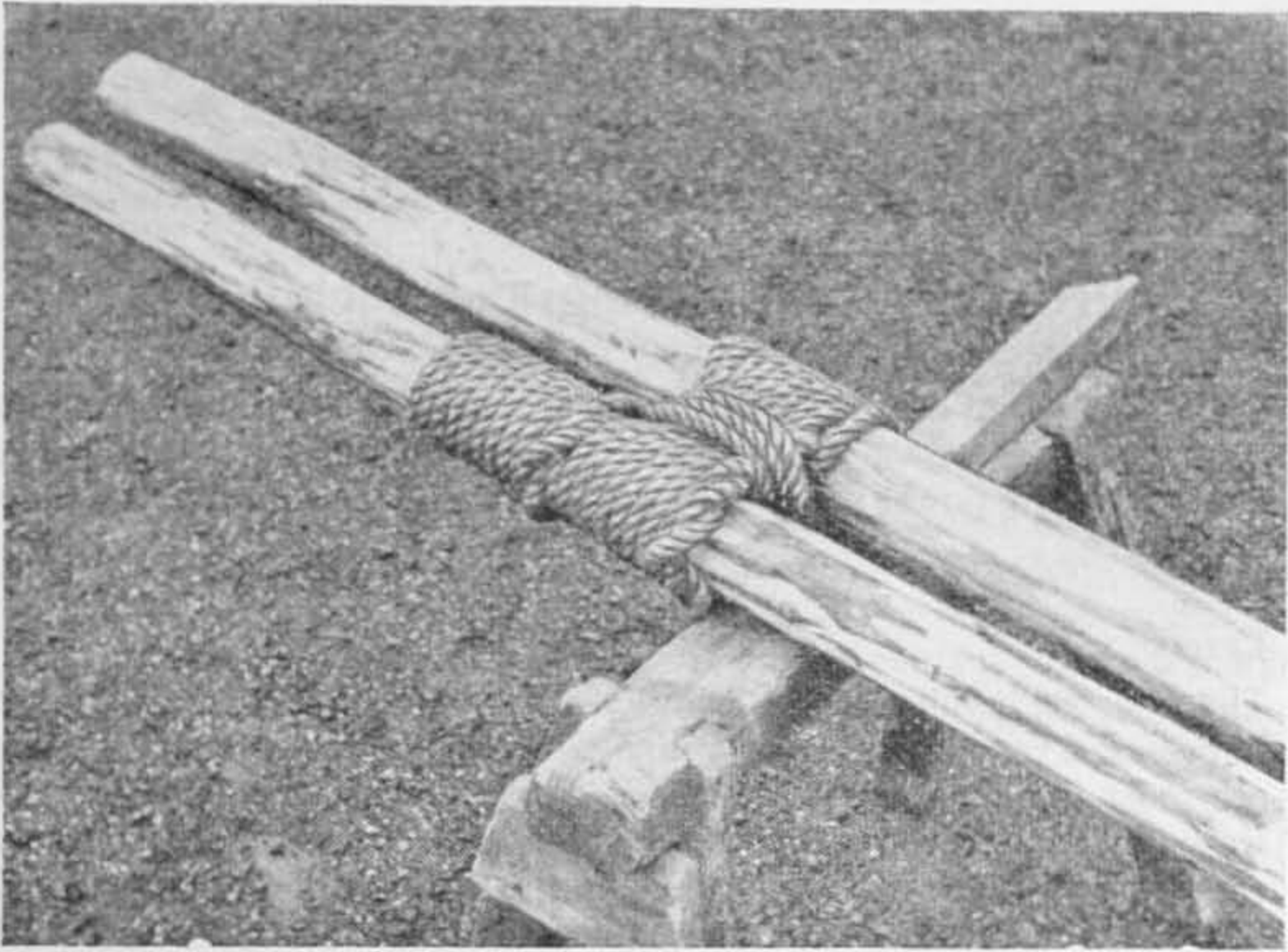

Fig. 67 (b). Round lashing

## CHAPTER 15

### Principles of Levering and Jacking

- 15.1 The principles of levering and jacking are, in a variety of differing ways, brought into most aspects of rescue work. The purpose of lifting appliances is to gain power so as to lift a large load with a small force suitably applied.

#### Lever

- 15.2 The simplest appliance for gaining power is the lever, of which an improvised version made of laminated timber or an ordinary crowbar are most frequently used by rescue workers. There are two principal ways in which a lever can be used, as illustrated in the diagrams. In each case the advantage gained depends on the distance of (A), the centre of the load, and (C) the points where the push or force is applied from (B), the heel or fulcrum.

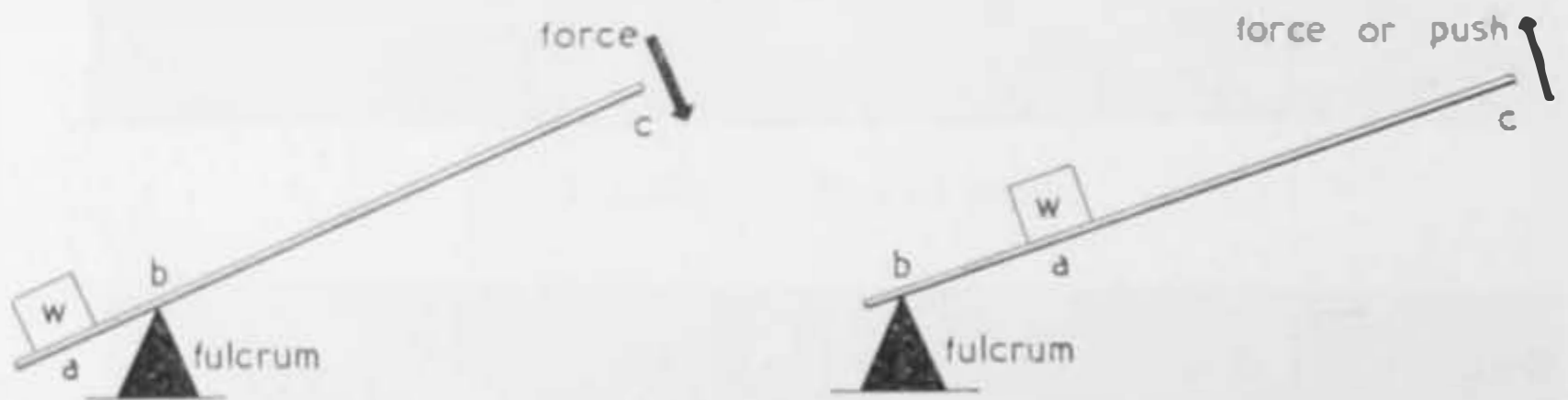

Fig. 68. Lever (downward force)

Lever (upward force)

- 15.3 The relation between the load and the amount of force required to lift it is in the same ratio as the length BC is to AB, where AB and BC are the distances of the weight and the force respectively from the fulcrum. A man using a 10-foot lever and bearing down at C with half his weight, say, 6 stone or 84 lb., against a fulcrum 1 foot from the other end of the lever, can lift a weight of  $84 \times 9 = 756$  lb. because the length from fulcrum to hand is nine times the length from pivot to weight. If B is only 6 inches away from the weight the ratio is increased to 19 times its own weight.

#### Fulcrum blocks

- 15.4 A fulcrum block should be of wood (hardwood if possible), never of brick or other crushable material. It must be resting on a firm base, which should be as large as possible so as to distribute the weight to be lifted. The fulcrum must be placed as near to the weight as is possible under the circumstances, and it should never be placed at any point where there is a possibility of a casualty being buried immediately below.

**15.5** It should, however, be remembered that there is a limit of strength to all levers, and if either the weight to be lifted or the applied force or both are not within this limit there is a distinct possibility of the lever collapsing. It cannot be stressed too highly that such a collapse of equipment whilst attempting to effect a rescue is not only the worst possible thing that could happen so far as the casualty is concerned, but is also a clear demonstration of lack of leadership, teamwork, and training.

### **Lifting**

**15.6** Power should be applied as near to the end of the lever as is practicable. The weight should be well packed with uncrushable material throughout its entire lift. Good packing is essential and should be kept up to the lift. Where more than one lever is to be used the weight should be lifted evenly, orders being given by the leader in charge. Where a metal bar is being used against metal, a wood packing piece should always be inserted between the toe of the lever and the weight to be lifted. It must never be metal against metal. The toe of the lever should have a good bearing underneath the weight to be lifted to avoid crumbling of the edge when leverage is applied.

### **Lifting jacks**

**15.7** Lifting jacks are of three main types (1) ratchet, (2) screw, and (3) hydraulic. The Rescue Section is equipped now with hydraulic equipment (see Chapter 25) but it is well to know something of the two other types of jacks which might be available to the section in an emergency. In any case many of the principles apply to use of all three types.

(i) *Ratchet jacks*—With this type of jack the load is raised by means of a long lever working against a ratchet, in such a manner that the load is supported on the ratchet between each lifting stroke of the lever handle. This jack, though simple in action, has the disadvantage that, because of the ratchet, it is somewhat tall in construction and consequently cannot be used where the space is restricted. Ratchet jacks are fitted with a toe so as to get a lift from very near the ground. This toe, however, is generally capable of carrying only one-third of the total jack load. The load is lowered by releasing the ratchet, thus allowing the weight to come on to the lever. To avoid accidents, the jack is so constructed that the ratchet cannot be released until the weight is taken by the lever.

(ii) *Screw jacks*—As the name implies, this type of jack works on the screw principle. A lever is used to rotate the screw which in turn raises or lowers the load. The screw jack is very compact and safe in operation as it almost eliminates any risk of slip-back which in rescue work might cause serious accidents.

### **Use of jacks**

**15.8** For the effective and safe use of jacks, the following points must always be observed:

(i) The jacks should stand on timber or other footing, of sufficient size to distribute the load, otherwise, instead of lifting the load, the jacks will be forced into the ground.

- (ii) As the weight is raised it should be safely supported by packing with timber or other solid material in case the jacks should fail. The jacks should be relieved of the load as soon as possible. (Pack as you jack.)
- (iii) Suitable packing, such as sound or hard timber should always be used between the head of the jacks and the surface of any load liable to slip, such as when a metal to metal contact occurs.
- (iv) Every effort should be made to operate the jacks in a plumb position but, if this is not possible, suitable packing should be used to obviate slipping or skidding when the load is applied.
- (v) Ratchet and other tall jacks are fitted with a toe, so as to get a lift from very near the ground. This toe, however, is generally capable of carrying only one-third of the total jack load.
- (vi) Where two or more jacks are used simultaneously to raise the same load, they must be operated evenly to avoid tilting the load and also to avoid bringing too much weight on to one jack with consequent risk of failure.
- (vii) All jacks must be kept perfectly clean, well oiled and greased. They should be examined and tested under load at frequent intervals.

## CHAPTER 16

### Propping, Strutting and Improvised Supports

- 16.1 When the walls near windows or door openings are unsafe and are to be shored up, or when heads or sides of such openings are damaged, it is a sensible precaution to strengthen the opening by strutting.
- 16.2 The simplest method when the sides only need support, is to insert two uprights and "pinch" them into position by driving between them a strut slightly longer than the distance between the uprights which, if the strut has a slight bevel at one end, can be securely wedged into position (Fig. 69 (a)). Alternatively, the upright struts may be secured in position by means of horizontal struts tightened in place by pairs of folding wedges. Pairs, not single wedges, should be used (Fig. 69 (b)).
- 16.3 If the head has to be supported as well as the sides, timbers will have to be inserted under the head. If it is an arch, these timbers will have to be shaped or packed to fit its entire underside, depending on the shape the arch has assumed when damaged (Fig. 69 (c)).
- 16.4 Door openings which have been damaged and are unsafe, may be strengthened and strutted in a similar manner utilising sole-piece, side uprights, head pieces and struts all secured and tightly held in position by pairs of folding wedges.

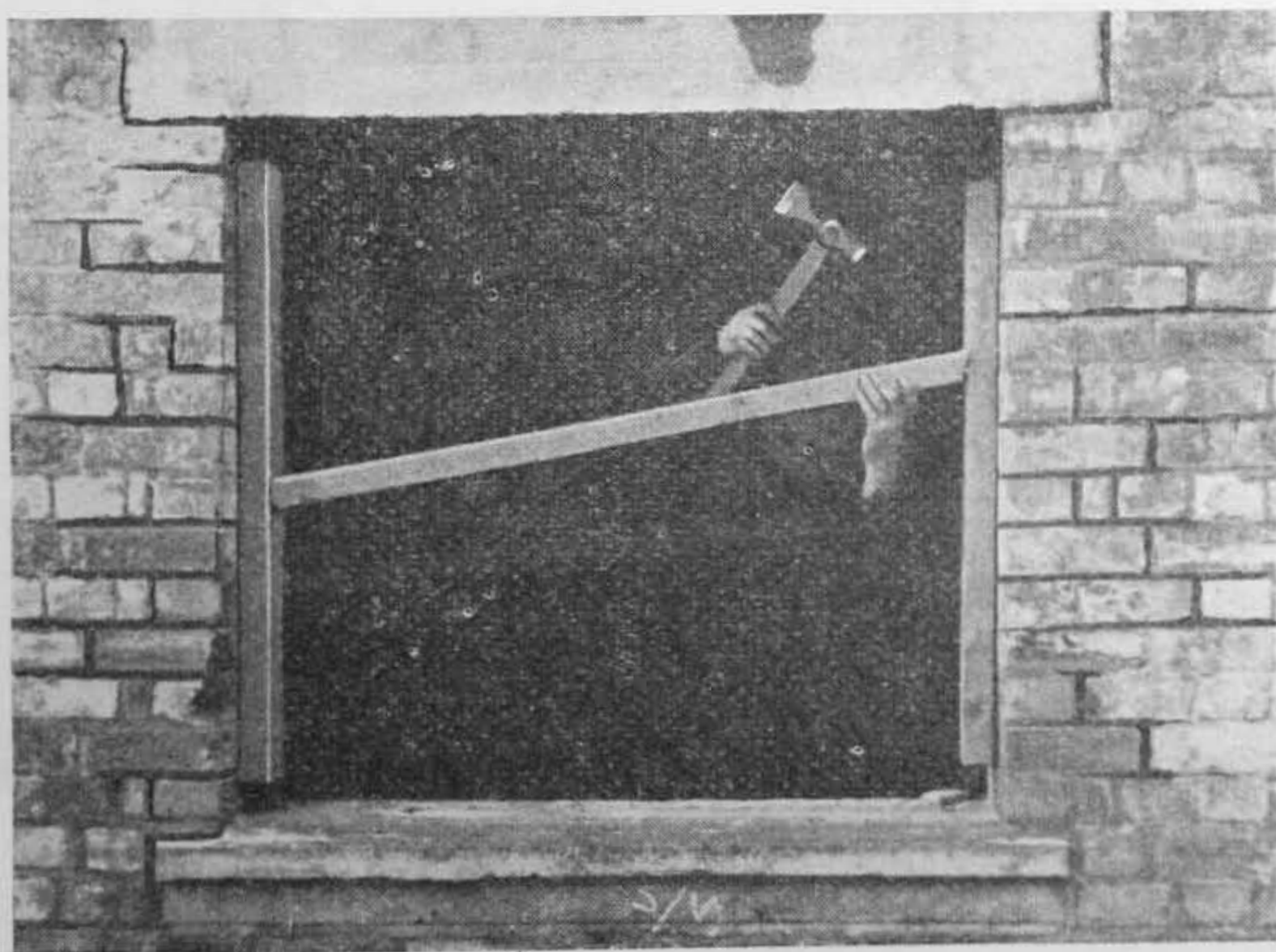

Fig. 69 (a-c). Strutting of window opening



Fig. 69 (a). Strutting of window opening



Fig. 69 (b). Strutting of window opening

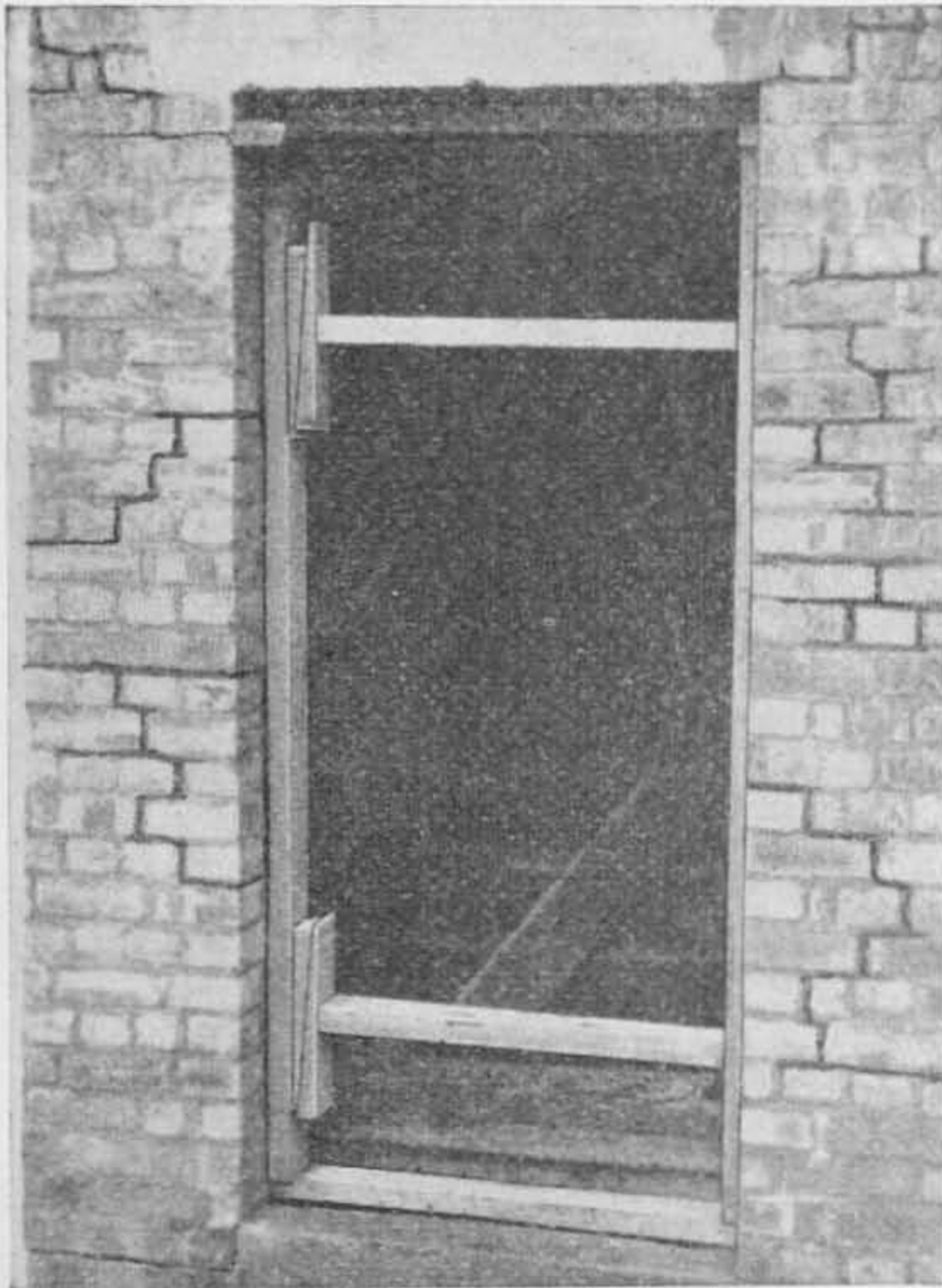

Fig. 70. Strutting a door opening

- 16.5** Many methods of strutting may be employed, but whether the opening be window or door, it may be necessary to leave sufficient room between the struts for a casualty to be brought through or to enable a rescue to be effected.
- 16.6** The principles of the construction of shoring can be applied in a great many ways, especially in the avoidance of further collapse of debris during rescue operations. Such propping can often be speedily effected, and provided it is soundly constructed will support the load and prevent its crushing the rescuers.
- 16.7** A collapsed roof can be supported by temporary strutting wedged up with folding wedges from a sole-piece nailed across the floor. Struts and head piece can be inserted under a collapsed floor to form an entry into the void beneath the floor and to enable access to be made without danger of further collapse. A strut inserted under the ridge of a collapsed roof can prevent further collapse while rescue work is effected.
- 16.8** Struts and bearers can hold back debris from the crawlway entrance to an opening leading under a collapsed floor; such a crawlway, if kept clear of tumbling debris, greatly facilitates the removal of casualties.



Fig. 71. Temporary strutting



Fig. 72. Utilising an old door, struttled back from the remains of a stone wall, to hold up debris and form a crawlway for the extrication of casualties



**16.9** Struts are not the only method of supporting the sides of a crawlway through debris. Fig. 73 shows an iron pipe used as a support wedged at the bottom by a piece of timber "Vee cut" to grip the base of the pipe, which is held back at the top by a wire bond which is taken to a convenient picket or holdfast.



**Fig. 73.** Improvised supports

- 16.10** Simple methods of debris support may often be employed to obviate the removal of much debris, thereby saving time and labour in the approach to trapped casualties.
- 16.11** The insertion of props in vital places may enable damaged upper floors to be reached and explored without the risk of further collapse and permit rescues to be carried out without further injury to the casualty or the rescuer.
- 16.12** The wire bond can also be used to suspend floors, and make them safe for work, as an alternative for instance to propping from the underside of a floor. (See Chapter 10 "Some uses of the wire bond".)
- 16.13** There are numerous applications of propping and strutting methods which will aid the success of the rescue work and the safety of those engaged in it. It is very important, however, that all such improvised work should be constructed and erected in accordance with accepted and established principles if the result is to be successful.

## CHAPTER 17

### Ladders for Rescue Work—Short Extension Ladder

**17.1** Ladders play an important part in rescue operations and it is essential that their construction and uses should be fully understood. Ability to handle and move ladders quickly and safely is an indication of good training and will ensure freedom from accidents and maximum efficiency. This chapter deals with the standard short 15 ft. wooden extension ladder.

#### Care of ladders

**17.2** In order to avoid damage, ladders should always be handled with care. Ladders which are not in service should be stored in a horizontal position with the tensioning wires underneath. The ladders should not be stacked more than seven ladders high. Three battens should be placed between each ladder, one at either end, about 2 ft. from the end, and one in the centre. Each additional group of battens should be placed accurately above those below and so maintain a vertical line of battens. The battens should be not less than 2 inches wide and of sufficient thickness to prevent the metal fittings on one ladder from coming in contact with the timber of the next ladder.

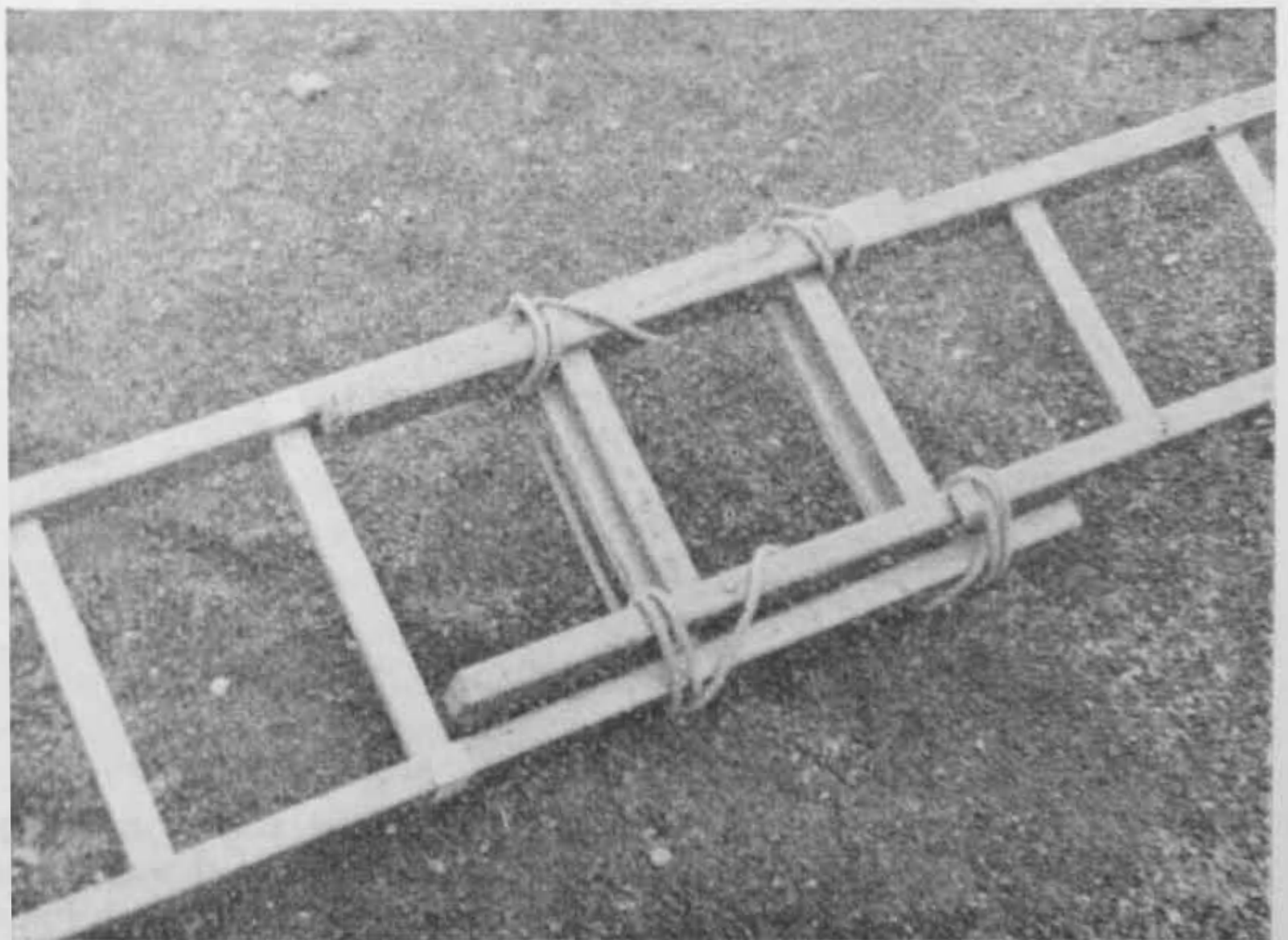

Fig. 74. Two short ladders lashed together

- 17.3 If a ladder is dropped it is important that it should be withdrawn from further service for examination and test by a competent officer to ensure that the ladder has not been damaged and become unsafe. It should be borne in mind that dropping a ladder even a short distance, or careless lowering, particularly on uneven ground or rubble, is likely to cause serious damage.
- 17.4 Ladders should under no circumstances be painted. Preservation of the timber should be by means of a clear varnish which enables any defects in the timber to be readily observed.
- 17.5 The short 15 ft. extension ladder can reach first floor windows of most dwelling houses and also into basements, and will prove valuable when making a reconnaissance. (Rescue Section personnel should also be taught how to lash two short 8 ft. ladders together to form a ladder approximately 13 ft. long, as short ladders of similar length may be in use at rescue operations by teams trained in light rescue).

#### **Use of ladders**

- 17.6 It will normally take two men to carry, fasten, and erect the ladders. Care must be taken that the reinforcement (if any) of a ladder is always on the underneath side of the load, and that a firm foundation is found for the foot of the ladder. In some cases it is necessary to tie or anchor the foot of the ladder to stop it slipping (see Fig. 75). At other times

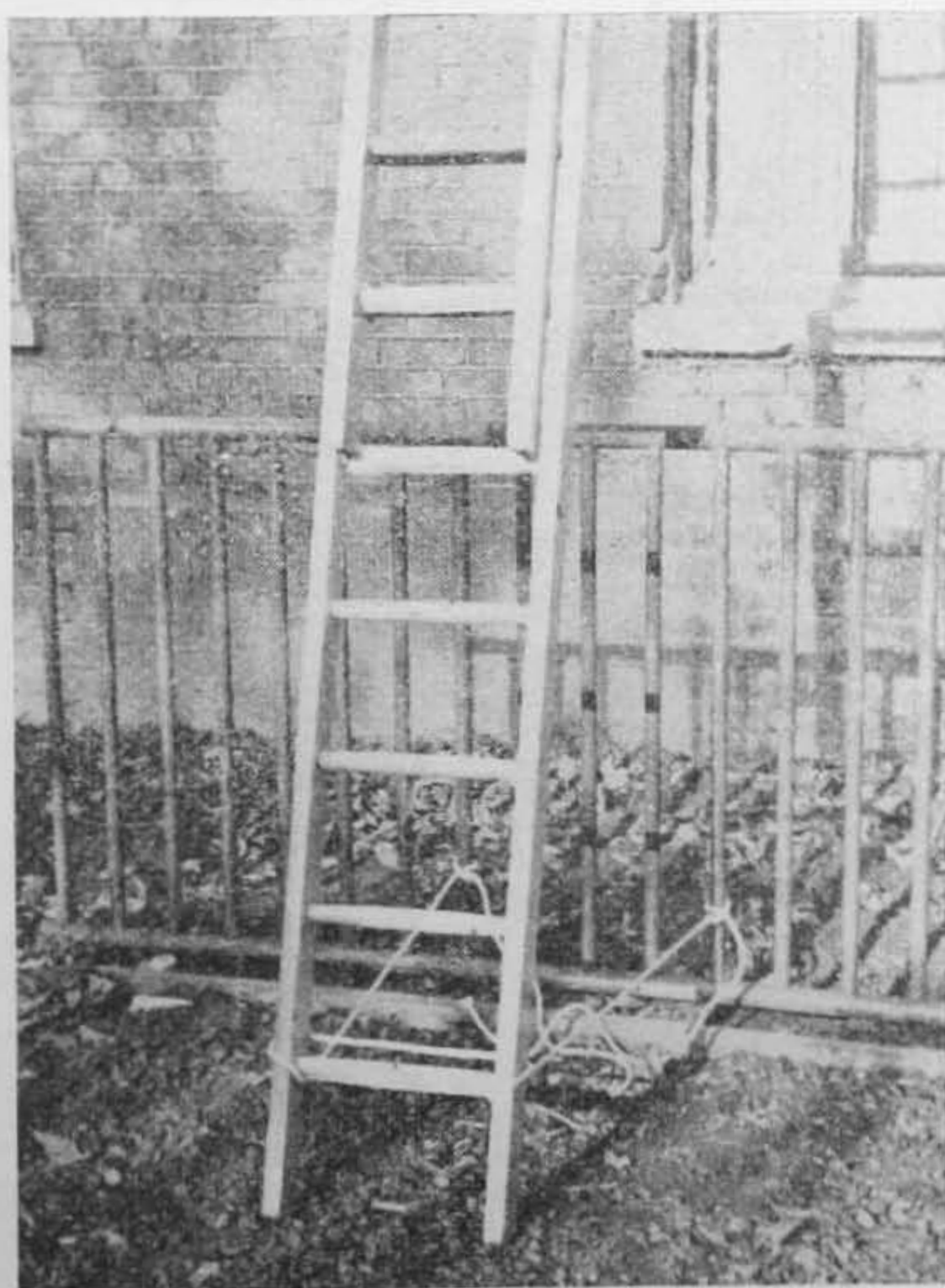

Fig. 75. Anchoring foot of ladder

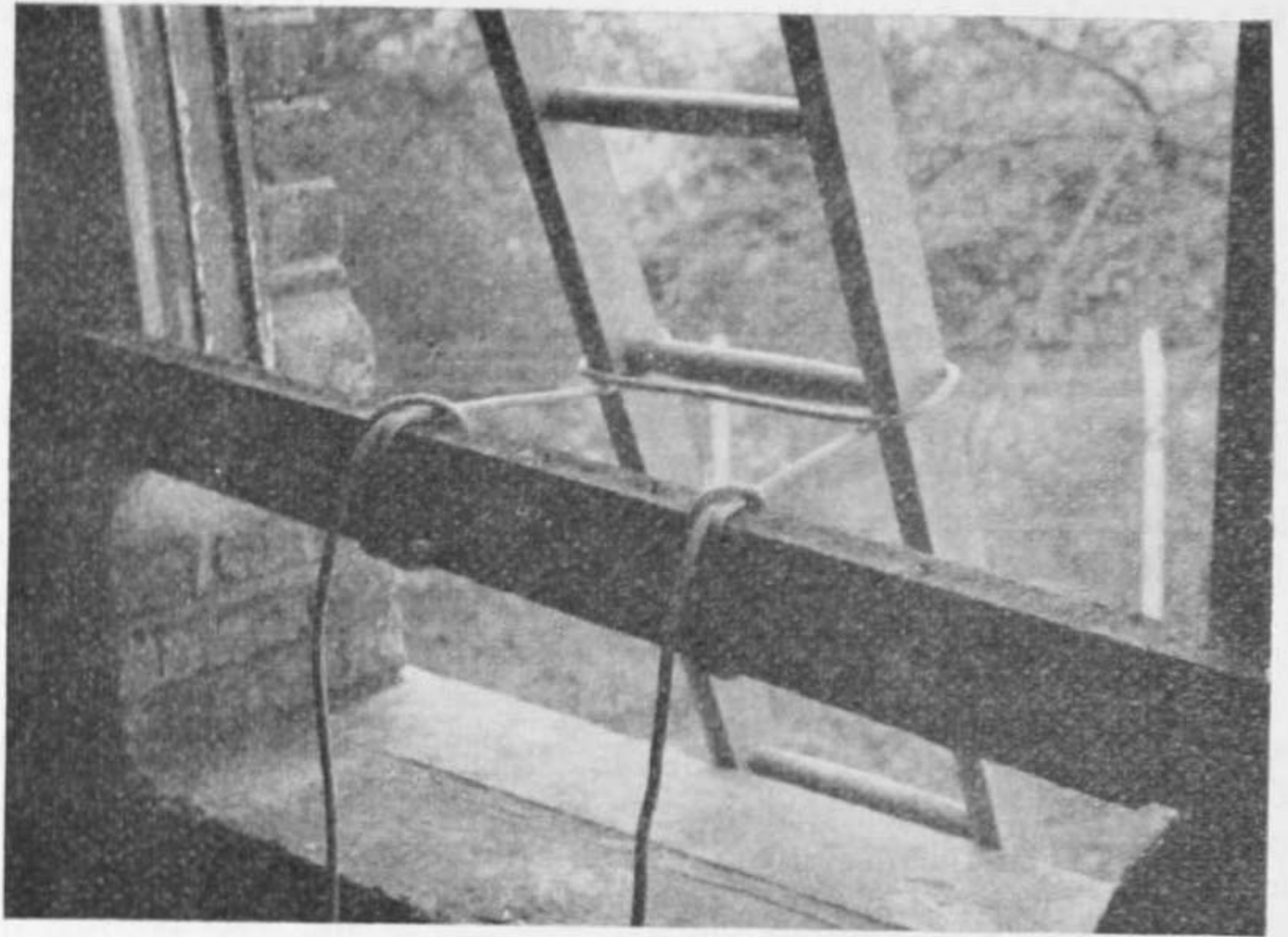

Fig. 76. Fastening head of ladder



Fig. 77. Passing a ladder over a wall

the head of the ladder may have to be fastened. One man must hold the foot of the ladder until the head has been secured (see Fig. 76).

**17.7** Short ladders are very useful for getting over obstacles, damaged walls, high fences, and the like (see Fig. 77). They can also be used for bridging a gap by placing one, or both side by side, over the opening (reinforcement if any on the underneath side) and putting a board, or boards, on the rungs of the ladder. Wherever possible, one length of board should be used on one ladder, but if this is not possible, care must be taken to overlap the ends of the boards where they meet (see Fig. 38, Bridging a gap). The ladder, or ladders, must be quite long enough to bridge the gap and give adequate support at either end.

### **Ladder climbing**

**17.8** The ladder should be climbed steadily, keeping the body erect, the head upright, the arms straight but not tense, without any tendency to hug the ladder, and the hands grasping the strings at a level between waist and shoulders. It must be remembered that the legs and not the hands carry the weight of the body when climbing, and at each step the ball of the foot, not the arch, should be placed on the rung.

## CHAPTER 18

### Rescue from Basements

- 18.1** Except in certain areas, most old domestic property and nearly all large buildings have basements or cellars sunk partly or entirely below ground level. In domestic property the normal way of access to such a basement is by a small staircase situated immediately below the main staircase of the house, while in a large number there is also access from outside. An important point to note about domestic buildings is that most of them are provided with some form of window, hatch or pavement light either in the pavement or in the court around the house and immediately below the windows of the ground floor.
- 18.2** In large blocks of terrace houses of good quality, access may also be by a stairway leading down from ground level into the sunken area which affords light and air to the windows of the basement, and in many cases leads to a door giving access to the basement. The area is usually surrounded by a low wall or line of railings.
- 18.3** In large buildings built alongside pavements, e.g., large commercial buildings, department stores, etc., basements may extend for some distance (sometimes 2 or 3 yards) under the pavement in which pavement lights, loading hatches, coal chutes, etc., may be found.
- 18.4** It is of the utmost importance that members of the Rescue Section should be familiar with the various types of construction used in basements, for many basements may be specially strengthened for use as a place of refuge. Basements of buildings known to be used by staff or the public, e.g., in department stores, should be examined by officers and leaders and small sketches should be made of the general lay-out, entrances, emergency exit, etc. In this connection much useful information can be gleaned from examination of architects' or builders' plans of local buildings. In some instances such plans may have been deposited with the local authority. (Where such plans are available they can also be useful in the training of party leaders.)

#### Forms of collapse

- 18.5** It is unusual for the outside walls of a basement to be damaged by blast, principally because they are below ground level and are therefore protected from the blast effects and because they are normally of greater thickness than the walls above ground. If, however, earth shock has formed one of the effects of an explosion, the basement walls may suffer damage. The outer walls of basements are unlikely to be less than 14 in. thick even in small buildings; in large buildings they may have a thickness of 3 ft. or more. Party walls that separate one basement from another are usually thinner than the outer walls of basements. In unframed buildings, the ceiling over the basement is more likely to be

damaged than the walls because it receives the full load of debris from the upper floors. This overloading may result in a partial or complete collapse of the ceiling, unless it has been suitably strengthened to withstand the probable load.

**18.6** Experience shows that when a basement ceiling collapses due to the weight and impact of debris from above:

- (a) the ceiling joists, while tending to break in the middle, may remain attached to the walls at their extremities and so form a "V" shaped collapse with voids against the walls at either end.



**Fig. 78.** Example of "V" form collapse (not in basement)

- (b) If the main weight of debris comes at one end of the ceiling joists, however, the joists may be broken off near the wall at this end and collapse to form only one lean-to against the opposite wall of the basement.

**18.7** In considering where lean-tos are likely to be formed when the joists over a basement have collapsed, it should be remembered that they are practically always laid the narrowest width of the room so that lean-tos are most likely to be against the longest side of the room.

**18.8** The formation of the voids mentioned above is of particular importance because they may protect persons in the basement from the main load of the debris and so enable them to be recovered alive. Voids can also be used to gain access to other parts of the basement or to basements of adjoining buildings.



Fig. 79. Example of lean-to collapse (not in basement)

*Reconnaissance in rescue from basements*

**18.9** The first essential is to try and discover the lay-out and extent of the basement, the location of the entrance (or entrances) and emergency exits and whether or not there are basements in adjoining premises. Steps should also be taken to try and determine by examination whether or not the floor above the basement has collapsed.

**18.10** Following a rapid investigation of these matters, entrance to a basement may be sought in one or more of the following ways:

- (i) by clearing an entrance leading to the basement;
- (ii) by clearing an emergency exit, manhole, coal chute, etc.;
- (iii) by breaking through the wall from an adjoining basement which has not been so severely damaged. To increase the probability of reaching quickly a void which may have been formed by the collapse of the basement ceiling, it is better to break through the wall at a point near a corner of the basement. Consideration must of course be paid to the construction and thickness of the wall. If the basement ceiling has collapsed, a mass of debris may be revealed when a hole is cut through the wall.



- (iv) Where the ground floor has not collapsed, a small area may be cleared of debris and entrance gained by cutting a hole in the floor.

18.11 Once access has been gained to a basement where the ceiling has collapsed, such voids as exist must always be propped and made safe against further collapse. This work can be done by some members of the party while others are attending to the casualties.

### **Ramps**

18.12 In some circumstances it may be necessary to construct a ramp from ground level to the basement wall, and then to cut through the wall and form a debris crawlway in order to link voids to effect the rescue of the casualty. This can be done by cutting a lane through the debris at ground level, and then digging out the ramp to basement floor level. It should always be borne in mind that the sides of the debris lane and the ramp may need supports to make them safe from collapse. Rough and improvised material for this purpose can generally be obtained on the site. Any timbering used should be heavy and firmly wedged into position.

18.13 Watch must also be kept for subsoil water, and where basements have been "tanked" with waterproofing material this should only be cut through above the level of the water table otherwise the basement may become flooded. Care must also be taken to ensure that no service pipes are fractured.

18.14 If a lean-to is formed by the collapse of the ground floor against one wall of a basement, there is likely (for reasons already explained) to be another lean-to against the opposite wall, and it may be necessary to cut a crawlway, and make it safe against collapse by adequate timbering, etc., through the debris from the first void towards the opposite wall in an endeavour to reach the second void.

### **Cutting through walls**

#### *Brick walls*

18.15 The procedure in piercing a brick wall should be to get a fairly small hole first, just large enough to get through, then enlarge it to the required size. The finished hole should never be larger than is absolutely necessary.

18.16 Brick walls built with lime mortar are usually easy to pierce, especially if they are old. As a rule the bricks can be withdrawn whole without difficulty. The hole made should be in the form of an inverted V. If there is any risk of collapse it may be necessary to put in some form of headpiece to prevent the bricks immediately over the hole from falling in.

18.17 Cement mortar is stronger than lime mortar; it is indeed as strong as the brick itself. Holes sufficiently large for rescue purposes can therefore be safely made in brick walls built with cement mortar.

18.18 It is possible to tell on examination whether a brick wall is jointed with lime or cement mortar. When damaged, lime jointed brickwork tends to fall to pieces and the individual bricks lie about almost undamaged,

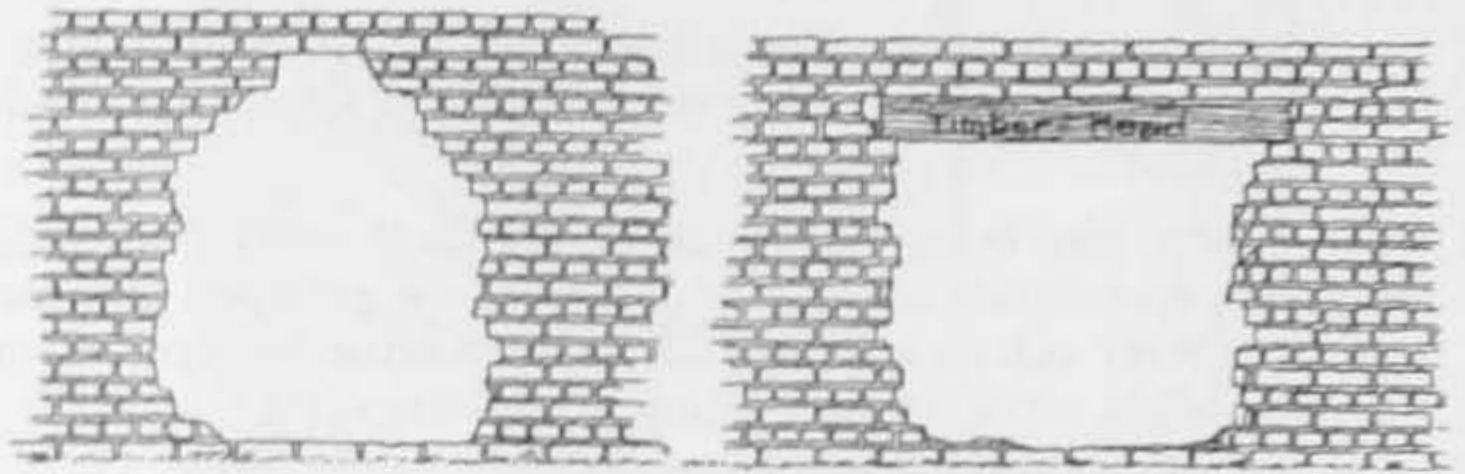

Fig. 80. Hole through brick wall: lime mortar

but walls built with cement mortar usually break up into chunks with the fracture going right through the bricks as well as the joints. If the wall is still in solid condition, a test can be made by scraping some of the mortar at one of the joints before deciding on cutting through. Lime mortar gives easily, but cement mortar is hard and difficult to scrape.

#### *Stone walls*

- 18.19** Walls of stone may be of various types with small or large stones and different ways of bonding. Only where a hole is cut through a wall made of fairly small loose stones is any support needed at the head. Stone walls are usually thick and difficult to cut through.

#### *Concrete*

- 18.20** It is almost impossible to cut with any speed through concrete. With concrete walls it is better to make a cut round the edges of the piece to be removed. If the wall is reinforced, the cut must be deep enough to reach the reinforcing bars so that these can be cut through.

#### *General*

- 18.21** When cutting into walls or floors of large buildings, great care must be taken to avoid weakening the main beams and columns supporting the building. Parts of a damaged building still left standing and apparently sound may be severely shaken and cracked. Therefore, when walls have to be cut, vibration should be reduced to the minimum as it may lead to further collapse.

## CHAPTER 19

### Rescue by Debris Clearance

**19.1** In general, there are two methods by which people trapped under a pile of debris can be extricated:

- (i) By clearance of debris, i.e. by removing the debris piece by piece until the victims are uncovered and freed.
- (ii) By the construction of crawlways and linking of voids.

**19.2** In both these operations, a very important principle must be borne in mind. If anyone survives at all inside or under a large pile of debris after a building has collapsed, it is because some heavy timber or a floor or other portion of the structure has fallen or remained fixed in such a way as to protect this person from the main impact and weight of the debris. In a similar way the presence of furniture can sometimes protect a casualty. Unless something of this kind has happened it is unlikely that the casualty will survive.

**19.3** This arching or lean-to may be of a very unstable nature, and, unless great care is exercised, it may collapse. Internal collapse can be avoided only by **disturbing the debris as little as possible during rescue operations** and by making sure that, as one portion of the debris is removed, the remainder is not dislodged and allowed to slide or fall in. Careful



Fig. 81. Debris of buildings

observance of these principles makes for greater saving in life in two ways: firstly, by minimising the risk of further injury to trapped persons, including possible suffocation by dust; and, secondly, by making for greater speed in the rescue operation, because the less debris that has to be handled, the less work there is to be done in effecting the rescue.

- 19.4 The question of how little debris need be moved to get rapid extrication is one which must be left to the intelligence of the leader. Sometimes the removal of the smallest possible amount of debris may not necessarily be the most rapid method of releasing the trapped person. Thus, it may be far quicker, in the long run, to move a heap of debris than to cut through a girder. Such factors as the accessibility of the debris to be removed, the number of men available for the work, the nature of the debris, etc., all have an important bearing on the question of how quickly the job can be done.
- 19.5 Whereas speed is unquestionably a most important factor in all rescue operations, speed without safety to both the rescuer and victims may quite easily defeat its own ends. The ideal is speed with safety.

#### **When debris clearance is necessary**

- 19.6 If no information is available as to the approximate position of persons trapped in debris, or if missing persons must obviously have been considerably displaced, rescue can usually be effected only by general debris clearance (Stage 5).
- 19.7 The essential difference between debris clearance as a rescue operation and debris clearance to clear a site is that, while the latter is straightforward and can be done after the life-saving phase by mechanical means, the former demands considerable expedition as well as care to avoid further injury to casualties.
- 19.8 In general, the guiding principle is that, so long as there is a reasonable chance of recovering casualties by debris clearance, it must be proceeded with by the rescue parties with unremitting effort. Subject to fall-out conditions, the Rescue Section must continue at work until it is certain that any persons still buried are no longer alive, and the responsible officer, according to local arrangements, decides that operations can be discontinued.

#### **Methods of debris clearance**

- 19.9 When debris clearance is undertaken for rescue purposes, the debris should, if possible, be moved clear of the demolished building, and not merely from one part of the site to another. The practice of "turning over" debris should be avoided wherever possible, as it usually leads to confusion and unnecessary duplication of work.
- 19.10 Debris can be removed by hand or by using receptacles found on the site, e.g., dustbins and buckets, and manhandling these to a selected spot where the debris is to be dumped. When removing debris in a confined space or over obstacles it is best to form a human chain. The bins, buckets, or other receptacles being used are passed from man to man and emptied at points known to be clear of casualties.

19.11 It may sometimes be necessary when clearing debris to cut a lane through this to reach a casualty. Great care must be taken in so doing to ensure that the sides of the lane do not collapse. These can be made safe, where necessary, by a simple form of timbering and strutting.



Fig. 82. A human chain for the removal of debris

#### Precautions in debris clearance

19.12 Great care must be exercised in the use of edged tools for the removal of debris, otherwise serious injury may be caused to casualties. Debris in the immediate vicinity of a casualty, or close to a place where a casualty is likely to be, should be removed by hand, using the debris gloves supplied for the purpose, or with the help of the entrenching tool. In this connection, it must be noted that it is sometimes far from easy to recognise a body in a pile of debris, particularly after a fire or when large quantities of lime and dust are present.

19.13 Men must not be allowed to climb about on top of a pile of debris during the clearing operation unless it is absolutely necessary. Where it is essential to clear debris from the top downwards, men should be stationed in such a position that they can pass timbers and other pieces of debris to one another. Timber should be withdrawn from debris only when it is certain that no further collapse will be caused with the possibility of additional injury or danger to persons trapped.

## CHAPTER 20

### Access to Voids : Linking of Voids : The Debris Crawlway

- 20.1 The removal of large piles of debris in order to recover trapped persons is usually a slow and laborious process. Therefore, when the position of trapped persons is known, it is often quicker, and in many ways better, to reach them by making a crawlway under or through the debris, linking existing voids wherever possible, so as to cause the least disturbance to the main pile.
- 20.2 Before the practical details of debris crawlways are examined, consideration must be given to the question of when and where they can be used to the greatest advantage. Although a crawlway may be helpful, it must not be imagined that it can be effectively employed on every rescue job. Under certain conditions, it is quicker and more efficient to drive a lane through the debris, e.g., where debris blocks the entrance to a line of bedrooms running on one side of block dwellings.
- 20.3 The first thing a leader must know before he constructs a crawlway is the spot for which he is making. This should either be the place where a person is known to be trapped (Stage 2), or some void underneath the debris from which further exploration of likely places (Stage 3) can be undertaken once an entry has been made. Unlike debris clearance, which may reveal the presence of casualties in all kinds of unexpected places, a debris crawlway is of little use for making a general search for casualties whose position is not known. Creating such crawlways is essentially a technique for reaching a specified spot and, as a general rule, should be carried out from the lowest possible level.

#### Strutting and lining

- 20.4 The construction of a crawlway in debris bears little resemblance to engineering tunnelling, although it may be necessary to strut and prop as the work proceeds. An important consideration is that the interior of a pile of debris may be in such an unstable condition that the removal of a comparatively small piece of timber or other obstacle may cause considerable movement. A careful look-out must, therefore, be kept for key pieces of this kind, and wherever possible, they should be allowed to remain undisturbed. They might even be further secured in position, so as to avoid accidental movement, by the fixing of a prop or other timber under them in such a way as to leave free passage for a man to continue the work beyond them. Recognition of these key pieces is, however, not always possible and, in such conditions, the only safe procedure is to prop and strut anything which might collapse as the work proceeds. Time spent in this way will not be wasted. It will prevent not only accidents and possible injury but the loss of time which is inevitable if the crawlway collapses and has to be started all over again.

**20.5** Material for timbering and strutting the crawlway can normally be found at the scene of the occurrence, the timber from the damaged building being cut to lengths as required.

**20.6** The shape and form of these crawlways may be so irregular as to make it impossible to follow any definite scheme of timbering such as can be applied in engineering tunnels. Simple props with headpieces are most suitable for holding in position large pieces of debris such as collapsed floors, roof timber and heavy pieces of masonry. The props must be wedged into position and fixed so that they will not slip or become loose and fall out if displacement takes place in the debris, but in no case should they be used to jack up or raise the debris. Props should be kept as nearly as possible in vertical line with the load taken so as to avoid sliding at the head. The feet can probably be held firmly in position by packing. Props must also be placed so as to avoid obstructing the use of the crawlway and, where possible, should permit the passage of a stretcher.

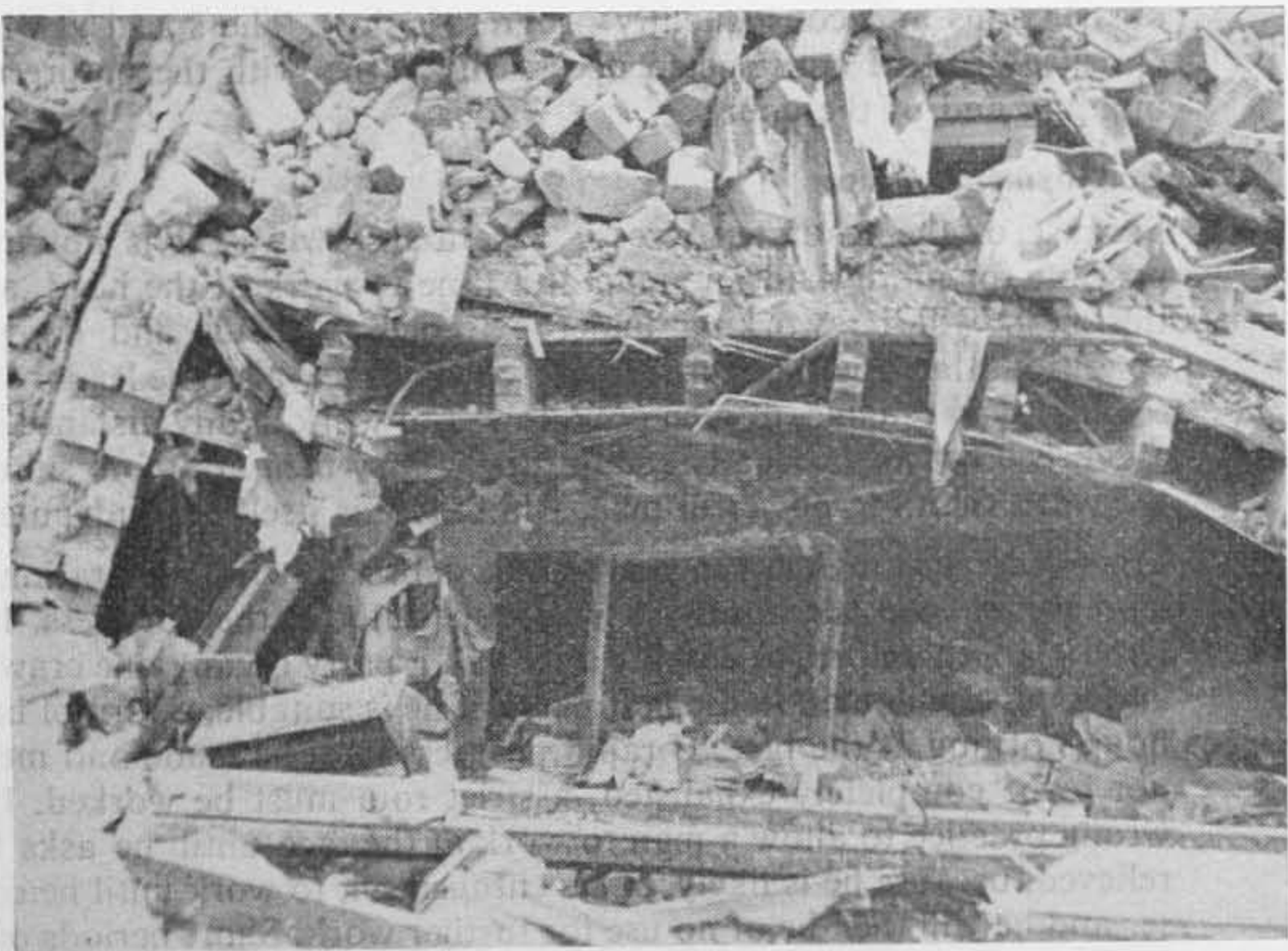

**Fig. 83.** Debris crawlway

**20.7** The debris of a demolished building usually includes large quantities of dust and small rubble, which tend to trickle through the timbering. Although this may not at first appear to be of much importance, the escape of the material in quantity may upset the mass of the debris, and cause further internal movement. The timbering used in a crawlway through small rubble or other finely broken material, therefore, should be as close boarded as possible.

**20.8** Whatever the form of strutting or lining employed in a debris crawlway, it must be rigid and wedged, not only to keep it in position, but also to

prevent it from being broken by impact, as might occur through movement in the debris. Wherever possible, a crawlway should be driven along against a wall, as this will greatly simplify the operations of strutting and timbering.

#### **Size of a debris crawlway**

- 20.9** The size of the timbers used for strutting is necessarily governed by the nature of the job and the material available. It is, however, better to have them too heavy rather than too light, especially having regard to the uncertainty of the weight they may have to carry. And, as has been stated, a crawlway in debris should, when possible, allow room for bringing out a casualty, hence it must not be too small nor the bends, too acute to prevent passage of a standard or improvised stretcher.
- 20.10** Another practical question affecting the size of the debris crawlway concerns the relative advantages of: (a) making it small and so having less debris to remove, and (b) making it sufficiently large to enable a man to work quickly and easily. If it is too small, it is difficult to remove obstructions and consequently progress is slow. The speed at which a crawlway can be constructed necessarily varies with the nature of the building and of the debris.

#### **Employment of men**

- 20.11** Because of the restricted size of a debris crawlway it is not usually possible for more than one man at a time to work at the head, and as this man will be working under extremely difficult and dangerous conditions, he should be relieved at frequent intervals. The leader should see that only reliable, fit men are allowed to work at any distance inside a debris crawlway. Usually small, tough, wiry men are more suited for the work than big powerful men, whose size is itself a disadvantage.
- 20.12** When too many men are employed on a debris crawlway operation, they tend to get into one another's way, especially in the darkness. It is a good plan, therefore, to employ only half a party on any one crawlway, and to give each man in the half party, if he is suitable, a turn of half an hour working at the face. If rapid progress is to be made and men are not to be completely exhausted, a strict rota must be worked. It is a wrong practice to allow a man to work at the face until he asks to be relieved, because he is likely, in his enthusiasm, to work until he collapses and he will then be of no use for further work. Short periods of very intensive effort taken by men in regular turn is the right method to employ. The rest of the men in the half party should be kept in continued support of the man working at the face—clearing away debris that he has removed, passing him tools, timber for struts, etc.
- 20.13** While work is in progress, unauthorised talking or shouting must be avoided, as the giving and receiving of proper instructions and directions is not only of great importance but also may be a matter of life and death. No movement of any kind should be allowed on top of debris beneath which men are working, and a strict watch should be kept for any signs of the debris sliding or of walls collapsing, or of any other happenings that may endanger the lives of the rescue party or further injure or mutilate the people trapped.



## **Obstacles in constructing a debris crawlway**

- 20.14** In burrowing or cutting through debris, a great variety of obstacles have to be overcome, worked round or removed; anything from a steel joist to a grandfather clock may be encountered. Obstructions such as beds, projecting timber, or steel joists may have to be cut either with a saw or an oxy-acetylene or other flame cutter, but, before this is done, the piece to be cut must be firmly secured in position so as to prevent collapse as soon as the cut is made, particularly as the obstruction in question may be carrying a considerable weight of debris which, on collapse, may fall and block the crawlway. Indeed, it is so difficult to tell how an obstruction will fall or twist after being cut, that it is best to avoid cutting an important beam or girder, if it is possible.
- 20.15** When a flame cutter is to be used to remove a metal obstruction, an operation so difficult and dangerous that it is safer and probably quicker to remove the obstruction by some other method, great care must be taken to see that the debris round about is not set on fire. The best safeguard is to use a stirrup pump to soak any combustible material and to keep the pump in readiness for dealing with any fire that may be caused. It must also be remembered that the air in a debris crawlway is liable to become foul when a flame cutter is being used; unless, therefore, some means is employed to circulate the air, conditions may become unfit to work in, and trapped people may suffer.
- 20.16** When heavy obstructions such as blocks of masonry and large portions of brickwork are encountered, it is usually quicker to work a way round, over or under the obstruction, in preference to cutting a way through.
- 20.17** Large service gas pipes and water pipes may frequently obstruct a debris crawlway. It is always best to avoid cutting these pipes, but when this has to be done, the public utility services should be informed of the position, and asked to cut off the service. Even after this has been done there may still be gas or water in the pipes which will escape immediately the pipe is cut if preventive action is not taken.
- 20.18** No gas pipe above  $1\frac{1}{2}$  inch diameter should be cut without supervision from a gas repair squad. As the pressure in gas pipes is low, when a pipe has to be cut, bungs of rag, plasticine or clay pushed into the open ends of the pipe should suffice to stop the escape. Both ends of a gas pipe must be stopped up in this manner.
- 20.19** The pressure in water pipes is much greater, and large pipes of 3-inch diameter and over must never be cut but burrowed under or over. Small service pipes of lead, copper or alloy, up to  $1\frac{1}{2}$ -inch diameter, may be cut after being closed by hammering flat to reduce the pressure, and when cut, both ends sealed by being turned over on themselves and again hammered. Small iron pipes, up to 1-inch diameter, either from supply cisterns or on hot water or central heating systems which may still contain water, can be cut and the flow stopped by driving in tapered wooden plugs. (See paragraph 20.22 referring to the now common practice of using one inch copper tubing to encase electric wiring. This tubing could,

under rescue conditions, easily be mistaken for water piping.) Pipes of greater diameter should not be cut, as apart from the difficulty in cutting, the pressure of the water would probably be too great for any improvised method of stopping to be effective.

- 20.20** When a building is badly damaged, the electric wiring is liable to be fractured and to become tangled; the main supply fuses are likely to have blown, and the whole circuit may be dead. It is an essential precaution, however, to find and turn off the main switch; if this is not possible, all electric wires should be treated as alive until it is certain that they are dead. One way of ensuring this is to cut the wires with an axe with an insulated handle. If the supply is alive, the cutting of the wires will blow the fuse. Sparks may be caused in the process, but so long as these do not set fire to the debris or cause escaping gas to explode no harm will result.
- 20.21** The last paragraph applies particularly to the internal wiring of premises, and not to the underground mains which run under the pavement or the service cables connected to them. These cables can be identified by virtue of the fact that they have been buried in the ground and are usually armoured and/or covered with weatherproof serving. These cables should be dealt with in the same way as the larger water pipes, i.e. the crawlway should be driven over or under them pending the arrival of a representative of the electricity supply undertaking.
- 20.22** Electric wiring is to an increasing extent being carried within copper tube sheaths. This sheath is sometimes used as the neutral conductor. Rescue parties should therefore regard such copper tubes as possibly containing electric wiring. There is no danger in attempting to hammer the tube flat, and the attempt to do so will probably show whether the tube is a water pipe or not. When cutting through a tube which contains electric wiring, it is important that the cuts should be made with an insulated tool from one side to the other, making sure that the inner conductors are severed completely before the tube itself is completely severed; otherwise, if the tube is acting as an earthed neutral conductor, danger could arise.

#### **Removing spoil**

- 20.23** Rubble, broken timber, etc., extricated by the work at the head of the debris crawlway, must all be removed by the rest of the party and dumped clear of the work in a continuous process. The best plan is to form a human chain so that materials, removed by the worker at the head, can be quickly passed back from hand to hand until they are clear of the crawlway. As far as possible, the operations should be so organised that the worker at the head can quickly receive all necessary tools and timbers, and have all the debris he has removed quickly cleared out of his way without having to leave his place.

#### **Handling casualties in crawlways**

- 20.24** Severely injured casualties should be brought out on a stretcher where possible and, if necessary, secured to this by a stretcher lashing. The standard webbing bands should be used in preference to lifting the

casualty by hand, and as in most cases it is very difficult to determine at first the nature of the casualty's injuries, it is safer to assume that they are serious. Slightly injured casualties can be easily brought out through a quite small crawlway by means of a board to which the casualty is lashed, the board being drawn out by means of a rope attached to it. An uninjured person should be able to crawl out.

### **General precautions**

- 20.25**
- (i) Where dust is troublesome, a handkerchief or cloth worn over the nose and mouth will prevent serious inconvenience.
  - (ii) Protective helmets must be worn to avoid minor head and face injuries.
  - (iii) Dust goggles should be worn to save the eyes from dust and grit.
  - (iv) The man working at the face should have a life line attached to his waist, tied with a non-slipping knot (bowline) so that he can be easily traced if the debris collapses over or behind him.
  - (v) Debris gloves must be worn, as they save minor hand injuries which may cause unnecessary delays.
  - (vi) Extra care must be taken, especially in the use of edged tools, on nearing a trapped person.

## CHAPTER 21

### Pickets and Holdfasts

- 21.1** Pickets and holdfasts are used in rescue work for the purpose of making fast a line, a rope, a wire rope or chain which will be under strain. They fall within two main classes:
- (a) those which have to be set up, and
  - (b) those found in situ on the site.

#### Pickets

- 21.2** Pickets should be of sound timber, if possible of ash which is not only hard but has sufficient resilience to "give" rather than to snap as a softer wood might do. In most cases 5 feet is a suitable length, with a diameter, if of ash, of 3 inches, but if of softer wood a diameter of 4 inches and over may be necessary.
- 21.3** Pickets used for training which may need to be used time and time again should be carefully selected and will have a longer life if sharpened at the driven end, and bound with wire or an iron band at the head to prevent splitting by being frequently driven in.
- 21.4** Fig. 84 illustrates a single picket being driven in and shows how it can be held in position by a lashing line and thus driven at the correct slope in one direction and at right angles to the line of pull.

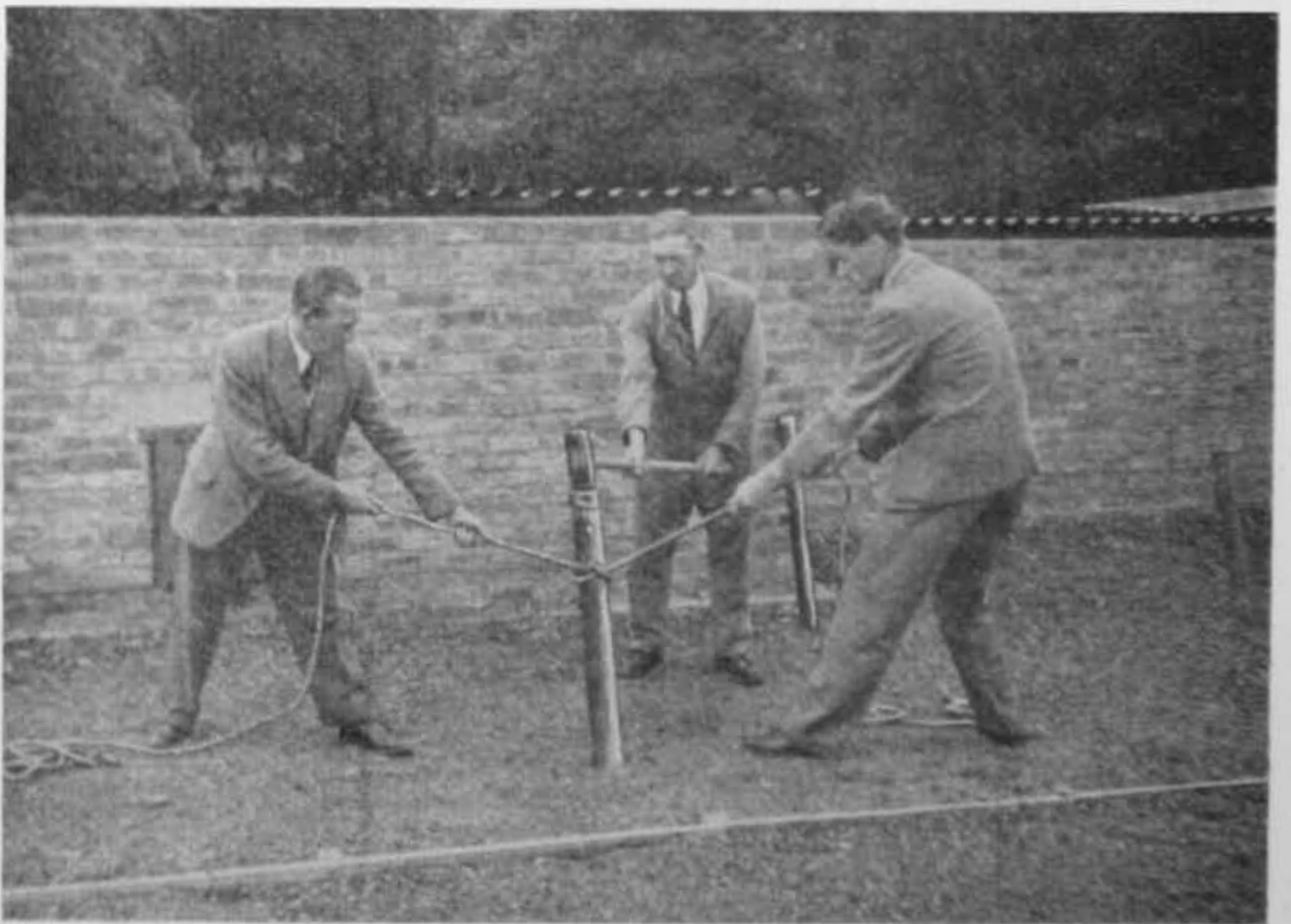

Fig. 84. Driving in a picket

- 21.5** In ordinary soil, pickets can be grouped for holdfasts for strains up to 2 tons. They may be used as single pickets as shown here, or may be formed into a holdfast arranged as a series of pickets in the line of pull. The pickets should be driven into the ground to appear upright when viewed from the front—and at a slope equal to 90 degrees to the line of the pull when viewed from the side as shown here. Normally, for security, they should be driven two-thirds of their length into the ground.
- 21.6** When used to provide anchorage for a guy, for instance from a derrick, the guy should be made fast to the picket with a round turn and two half hitches. A single ash picket of 3 inches diameter properly driven into good ground can normally be expected to take a safe load of 7 cwts.
- 21.7** For greater loads a combination of pickets should be arranged and these can be formed in line as one behind one, one behind two or one behind two behind three, according to need, known respectively as 1 and 1, 2 and 1 and 3, 2 and 1, the strongest picket always being nearest to the weight of load being taken.
- 21.8** The lashings connecting the pickets should be at 90 degrees to the pickets and should come from near the head of the picket in front to ground level at the backing-up picket. This determines the distance between the pickets, which however should never be less than 3 feet apart.
- 21.9** To lash a 1 and 1 picket holdfast using 40 foot  $1\frac{1}{2}$  inch lashing lines, make a clove hitch near the head of the front picket leaving enough running end to ensure that when this is married to the line, the twisted ropes will reach to and round the base of the backing-up picket. Fig. 85 (a) illustrates this. Make four to six turns around both pickets

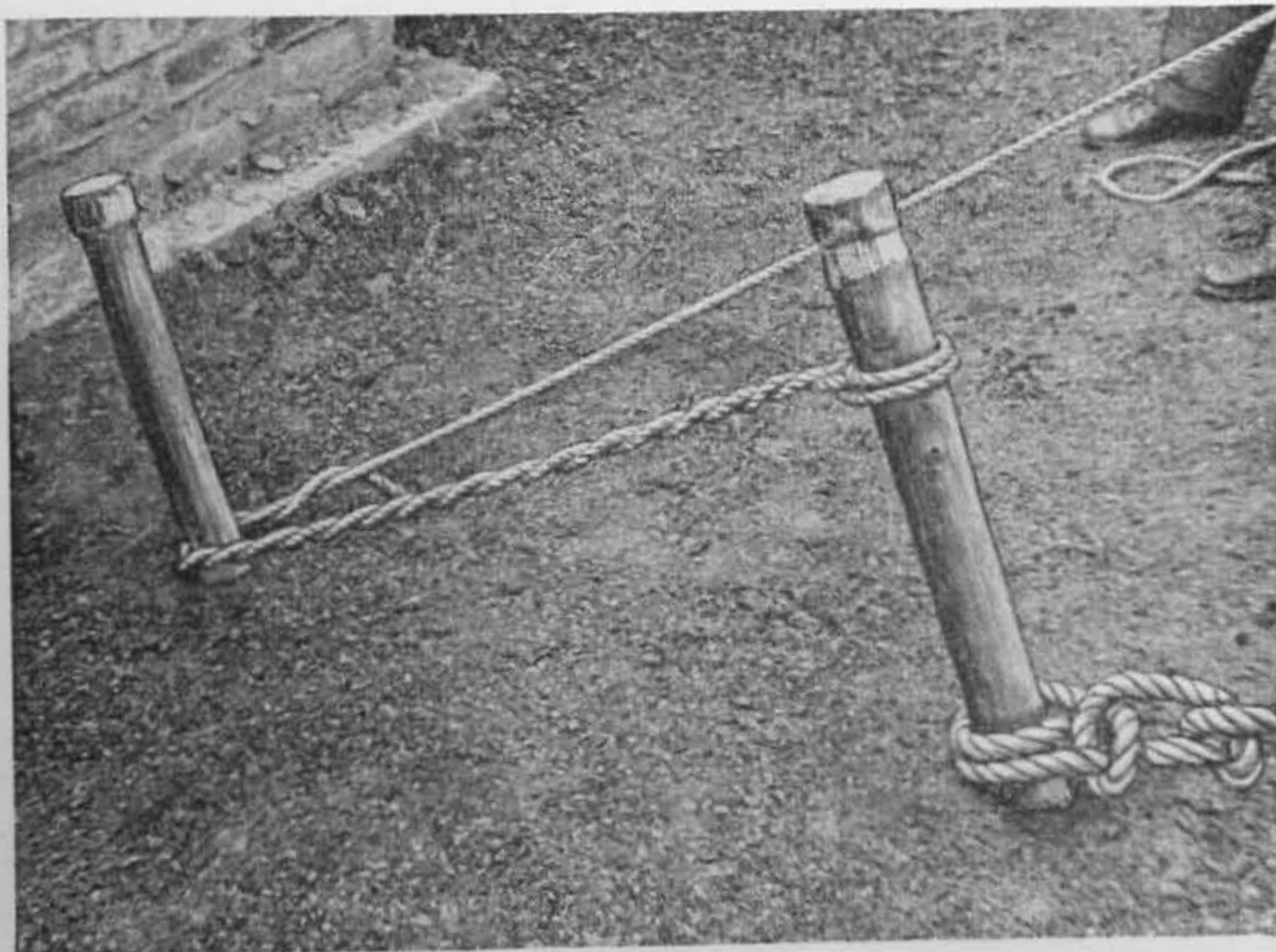

Fig. 85 (a). A 1 and 1 picket

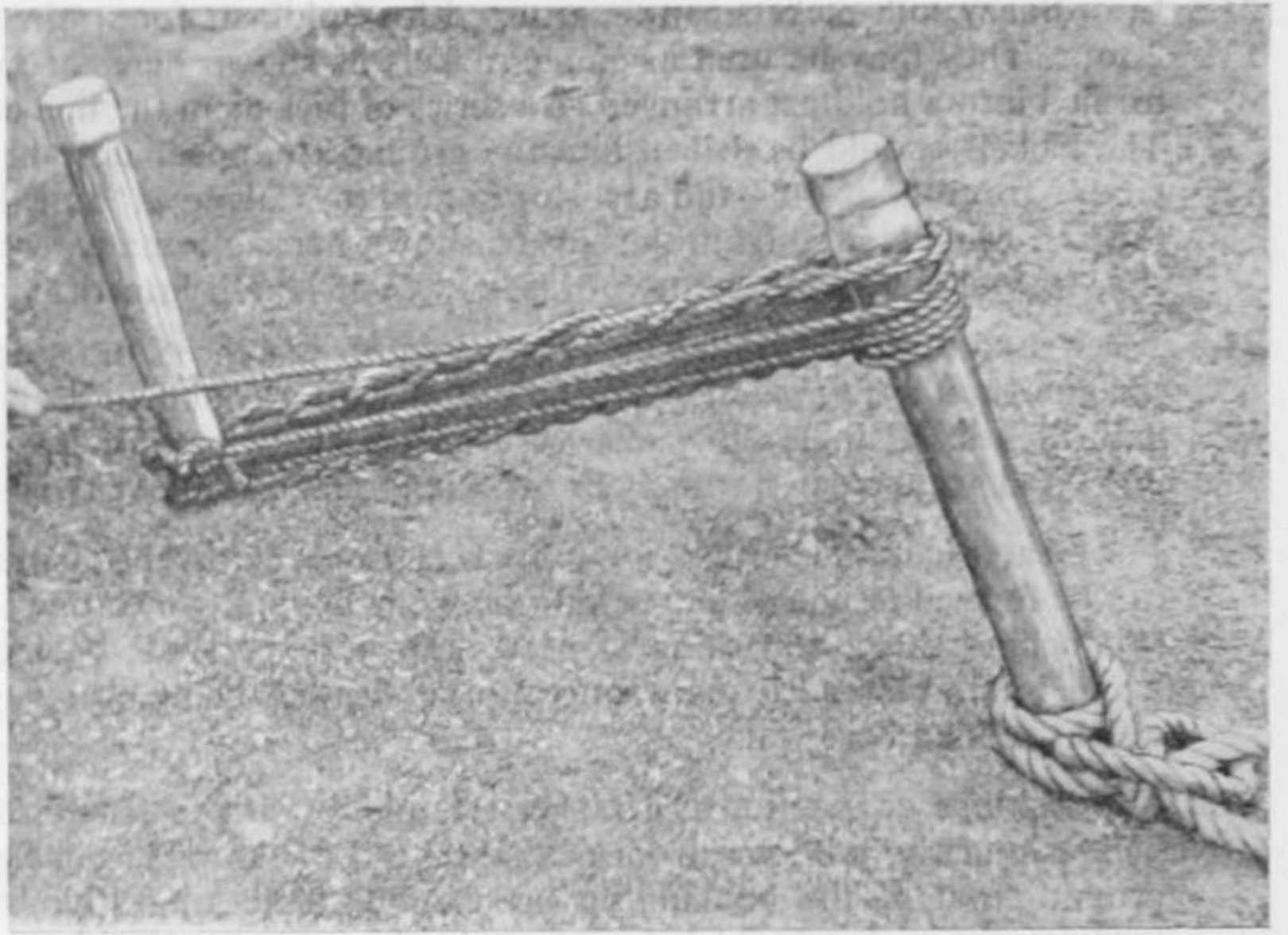

Fig. 85 (b). A 1 and 1 picket

“marrying in” an additional lashing line if necessary. Fig. 85 (b) shows this. Before applying frapping turns round the lashing, tighten up the turns by pulling on alternate lengths of lashing from each side, working from the first to the last turn put on. Two men bracing themselves with

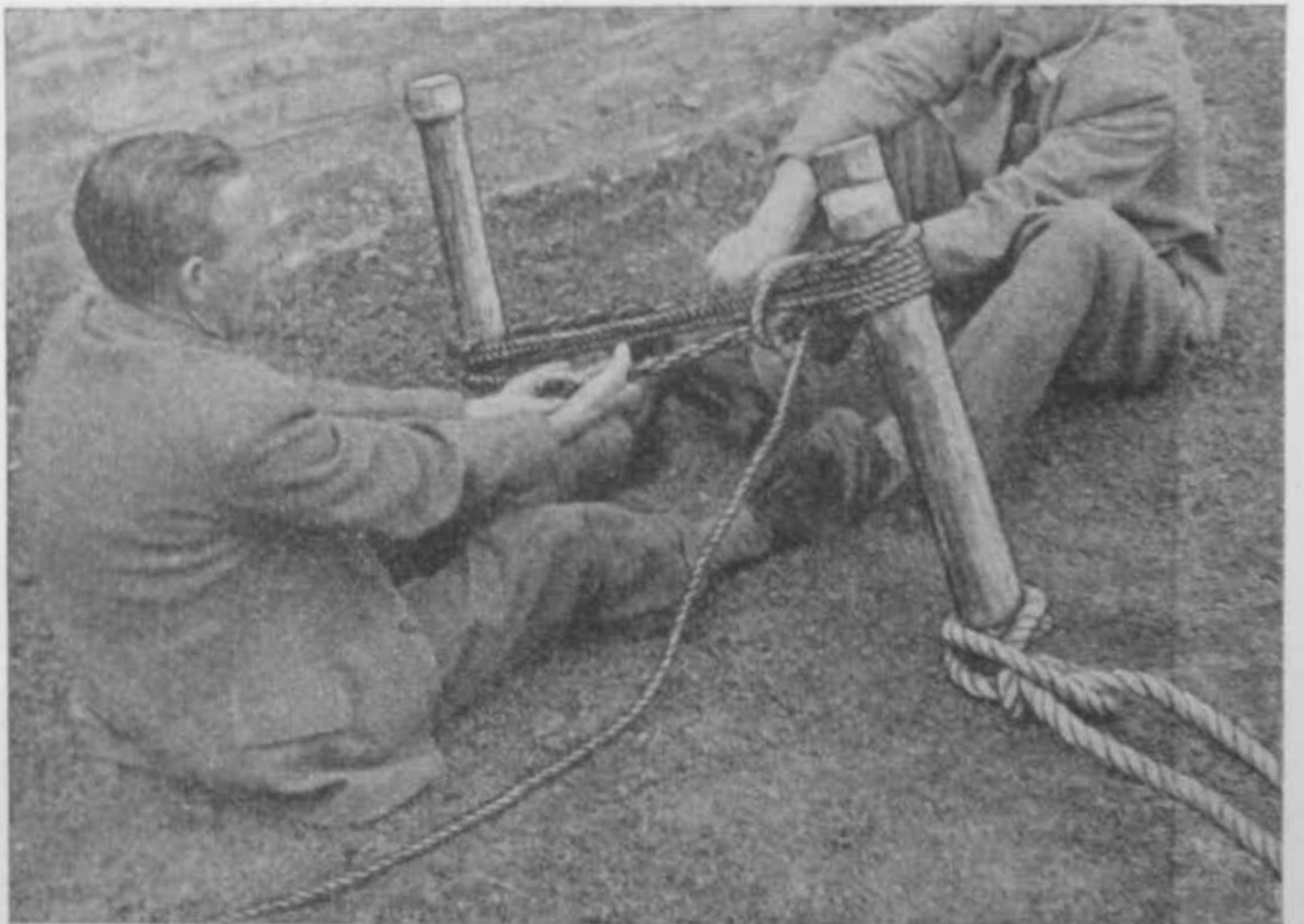

Fig. 85 (c). A 1 and 1 picket

their feet together can quickly and efficiently apply the necessary forces to tighten the turns. Fig. 85 (c) shows how. The 1 and 1 picket holdfast lashing is finished off by winding frapping turns around the turns, using up whatever spare rope is left, and finishing with a clove hitch around the lashing. Such a holdfast will take a load of from 12 to 14 cwt. See Fig. 85 (d).



Fig. 85 (d). A 1 and 1 picket

- 21.10** A two and one picket holdfast will take a load of 18 to 20 cwt. and is constructed as shown. The front pickets are driven in side by side close together, and the backing up picket at least 3 feet behind. The lashing is made as previously described, and all turns must be tightened before the frapping turns are put on. The guy is attached to the front and stronger picket by a round turn and two half hitches. See Fig. 86.
- 21.11** A completed 3, 2 and 1 picket could be expected to take a load up to 2 tons if the pickets are sound and properly driven into good ground and securely lashed. Care should be taken, in setting out, that the pickets are in a straight line with the direction of the line of pull. See Fig. 87.
- 21.12** As regards pickets generally, a picket in soft ground will be pulled out if subjected to too great a load, but in hard ground it will break off at ground level. The picket is normally the weakest part of any guy, etc., and should be carefully watched throughout the operation, since it will give an early indication of any excessive strain on the guy. Failure by pulling out usually occurs gradually, but breaking of the picket is liable to occur suddenly. In driving pickets of different sizes, the strongest should be nearest the weight. Whenever possible, they should be withdrawn in the same direction as they were driven. They should never be loosened by hitting them sideways, as this may break them.

#### **Holdfasts**

- 21.13** Baulk holdfasts can be constructed and may consist of a baulk of timber placed between lines of pickets lashed as described. Packing

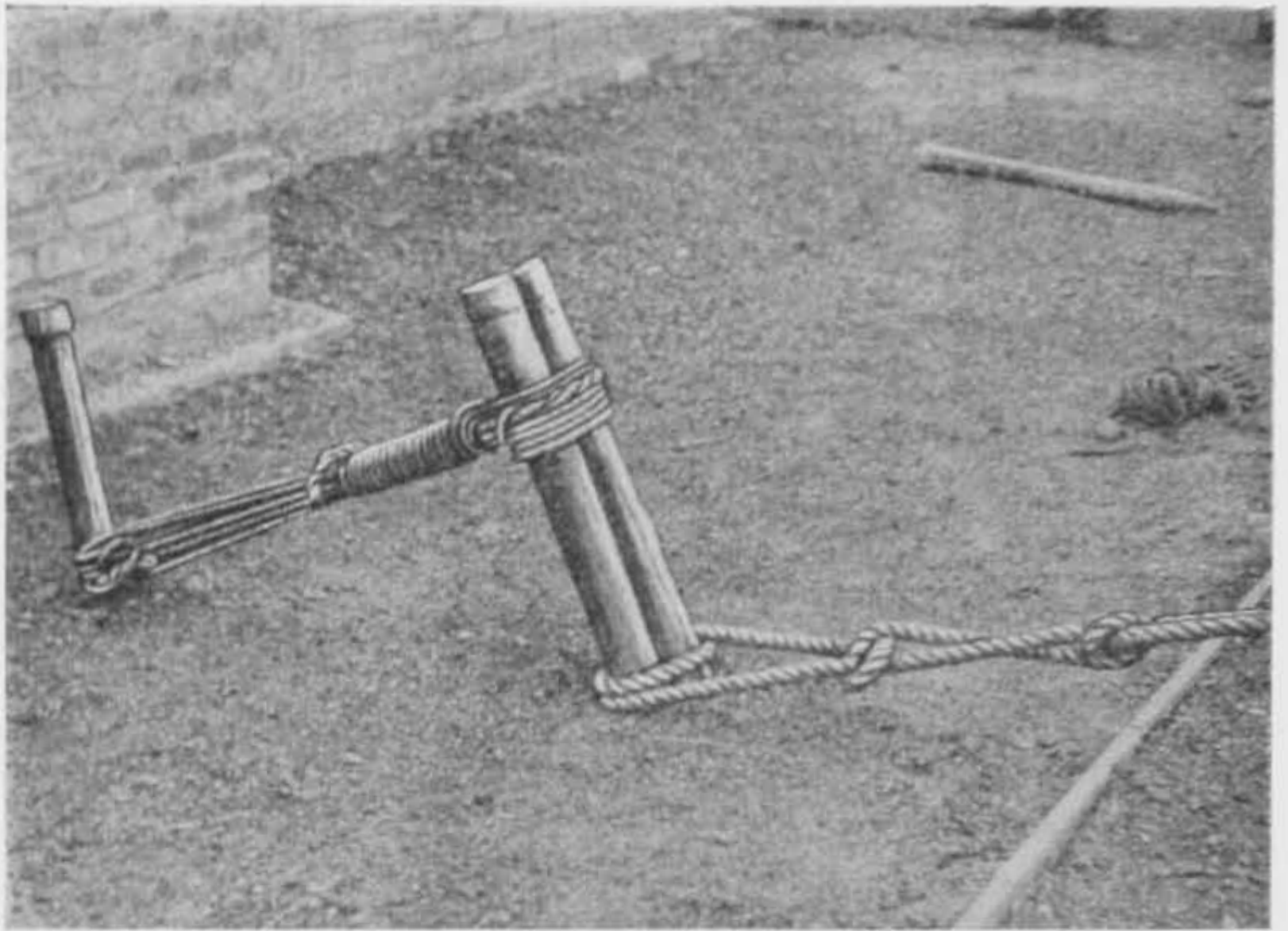

Fig. 86. A 2 and 1 picket

pieces should be placed round the baulk to round it out to provide a bearing for a wire rope, and to ensure that the diameter of the round turn is at least 6 times the circumference of the rope.

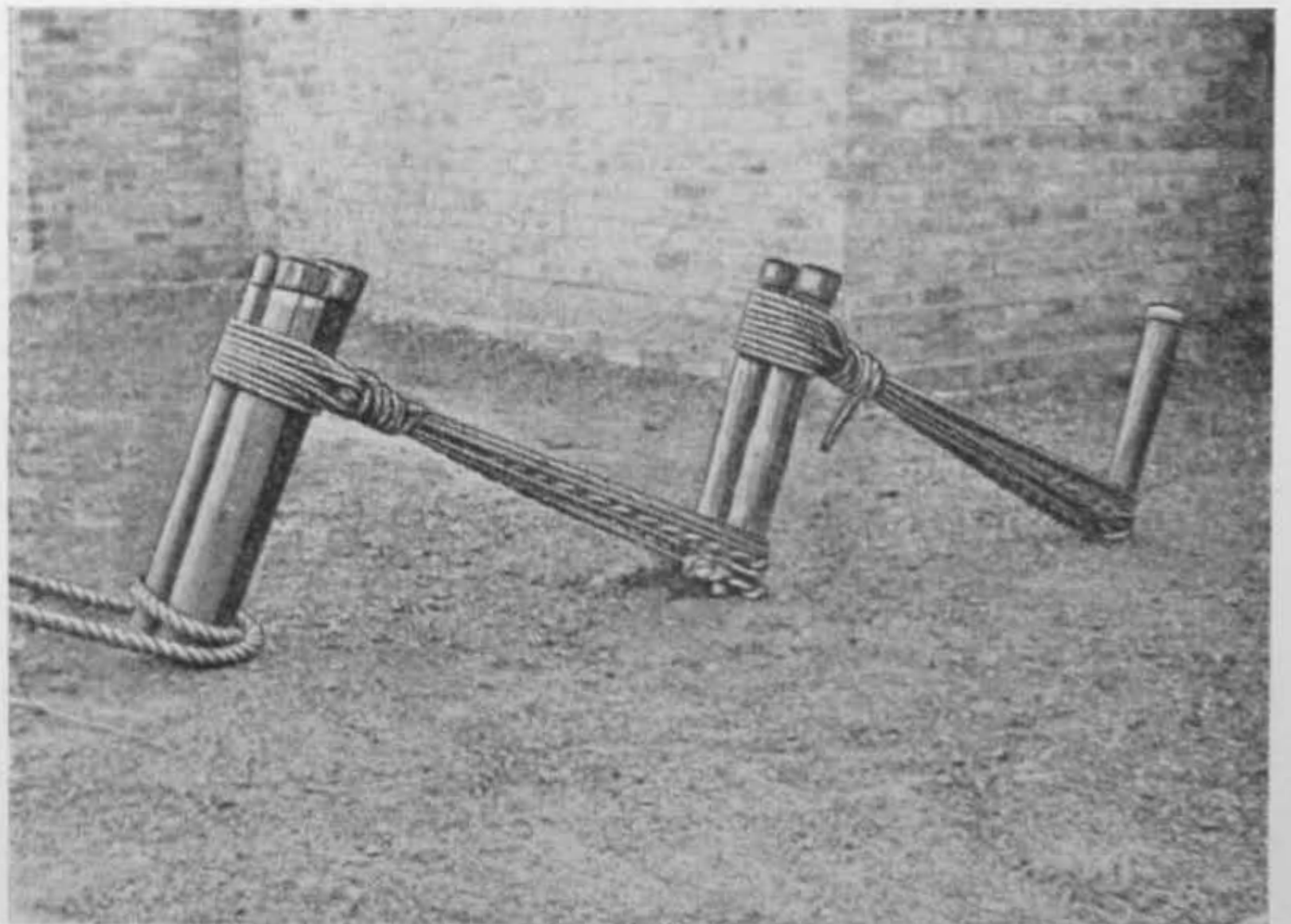

Fig. 87. A 3, 2 and 1 picket



- 21.14** Buried holdfasts are constructed by burying a baulk of timber or a girder in a trench cut with the front face at 90 degrees to the pull. A connecting trench to take the guy should be cut to accommodate the slope of the guy. The ends of the trench should be filled in and rammed over the baulk, but it is advisable to leave the guy fastening visible for inspection. See Fig. 88.

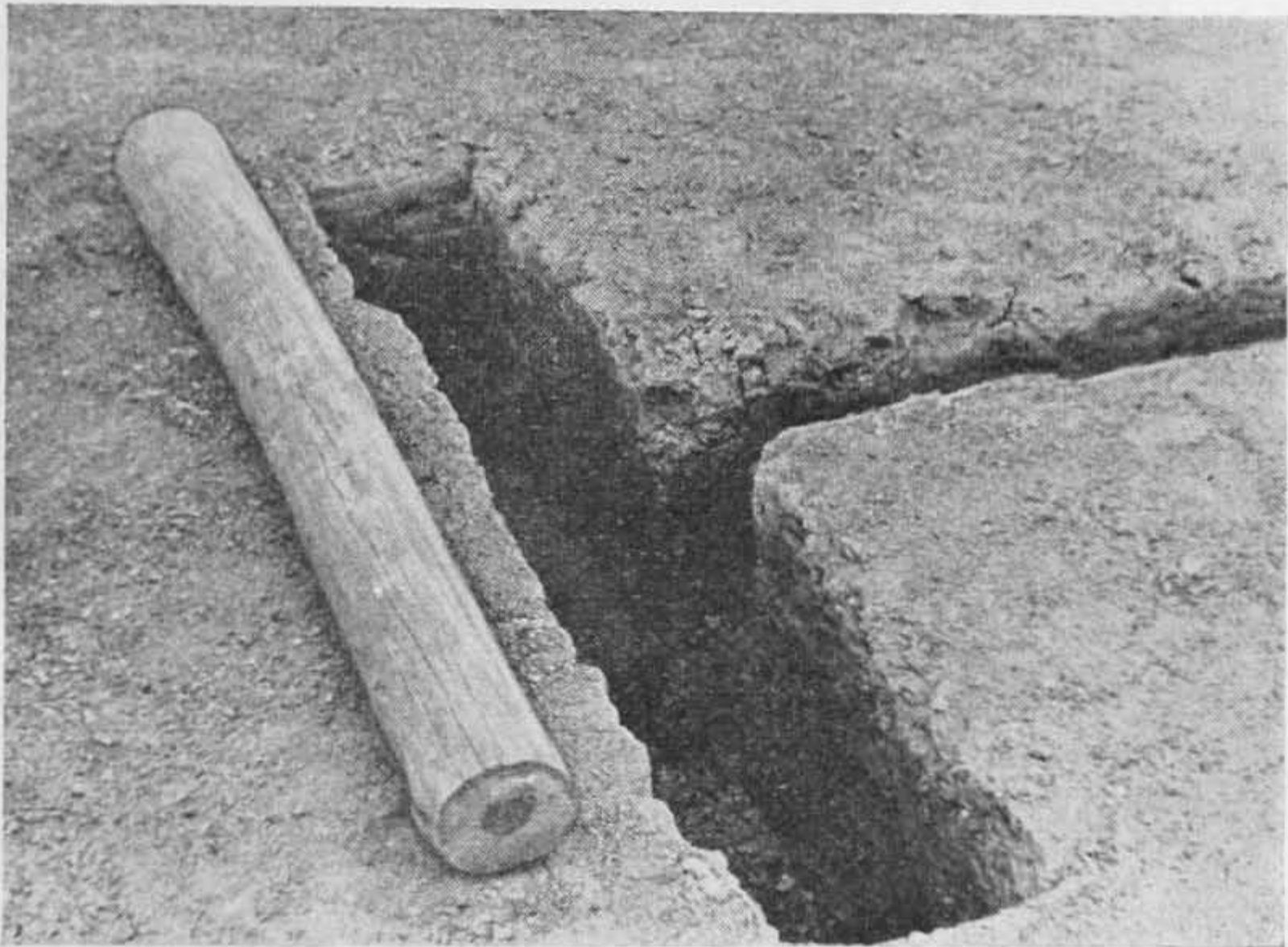

Fig. 88. A buried holdfast

#### *Improvised holdfasts*

- 21.15** In addition to driven pickets and baulk holdfasts, many improvisations can be made and secure anchorage obtained. Baulks of timber placed across openings in buildings and between strong brick piers or other strong objects may be utilised. Always ensure that the timber used is long enough to give ample bearing on each side of the opening so as adequately to distribute the load. An example is shown in Fig. 89 (a). A baulk of timber placed under the opening of a street manhole to act as a spreader makes a good improvised holdfast. Here again the bearings of the timber must be adequate. See Fig. 89 (b).
- 21.16** Among other holdfasts frequently to be found on the site and suitable for use as anchorages are lamp standards or posts. Reinforced concrete or steel standards used as lighting or cable bearers are strong and reliable and make good anchorages. A telegraph pole is equally suitable and forms a good round bearing for a fibre rope. The rope should be protected from damage from chafing, when fastened to a rough or irregular object, by a piece of sacking wrapped round the object.

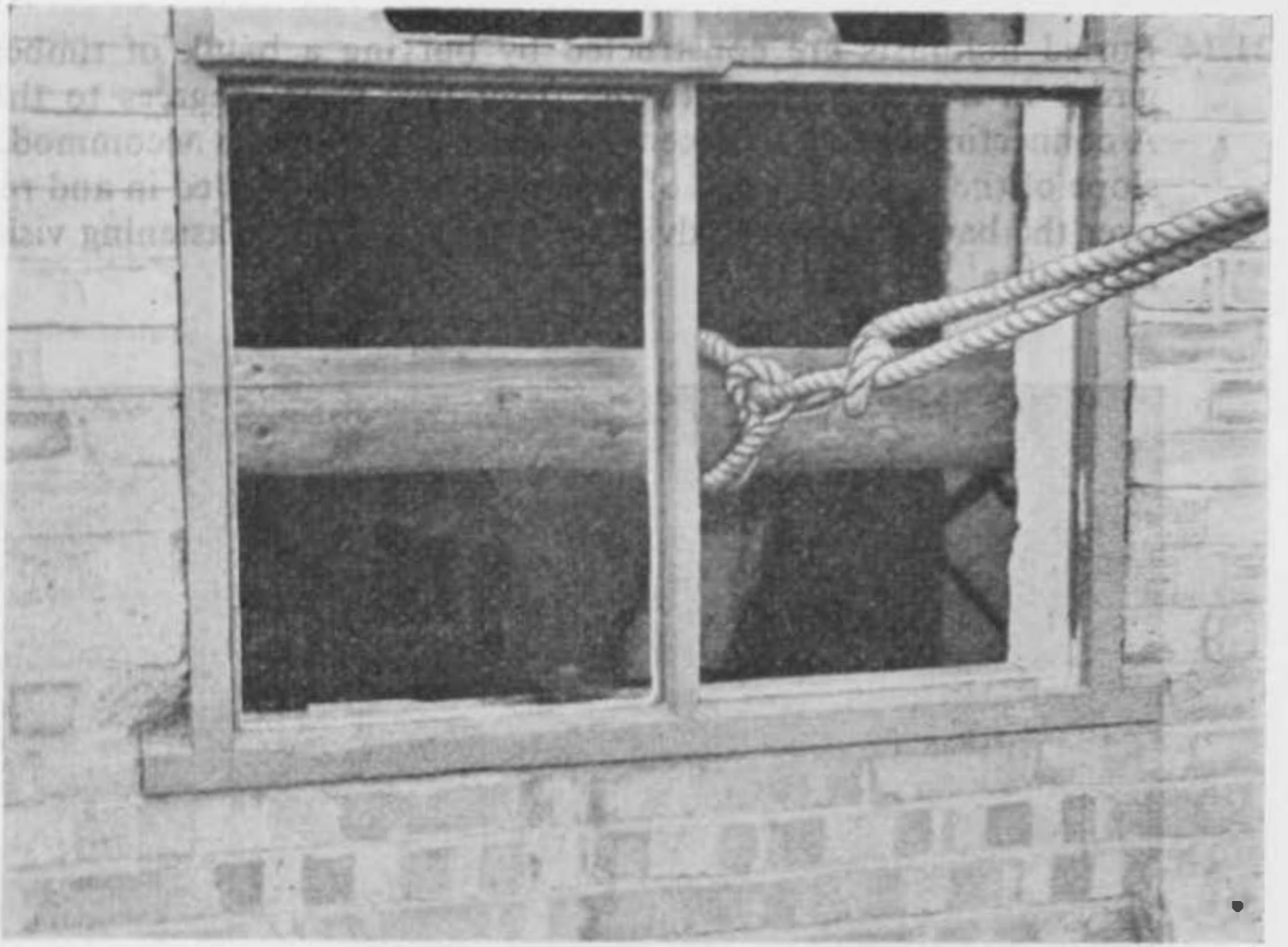

Fig. 89 (a). Improved holdfasts

**21.17** A square gate post of wood or concrete should be packed with pieces of timber to form a bearing less liable to cause damage to a fibre rope chafing on the hard square corners. Note the method of attaching the guy rope to all the holdfasts shown—a round turn and two half bitches. A well

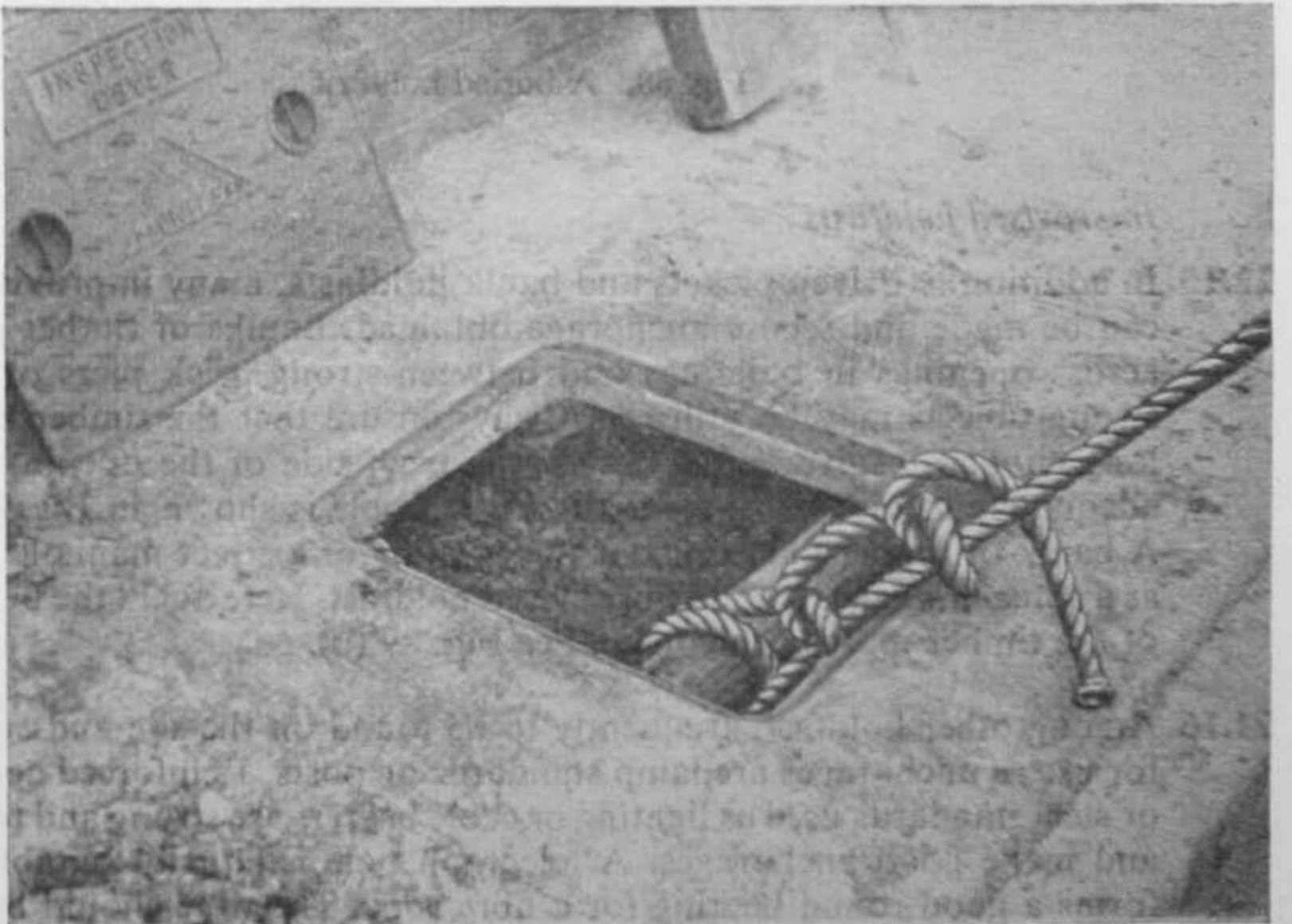

Fig. 89 (b). Improved holdfasts

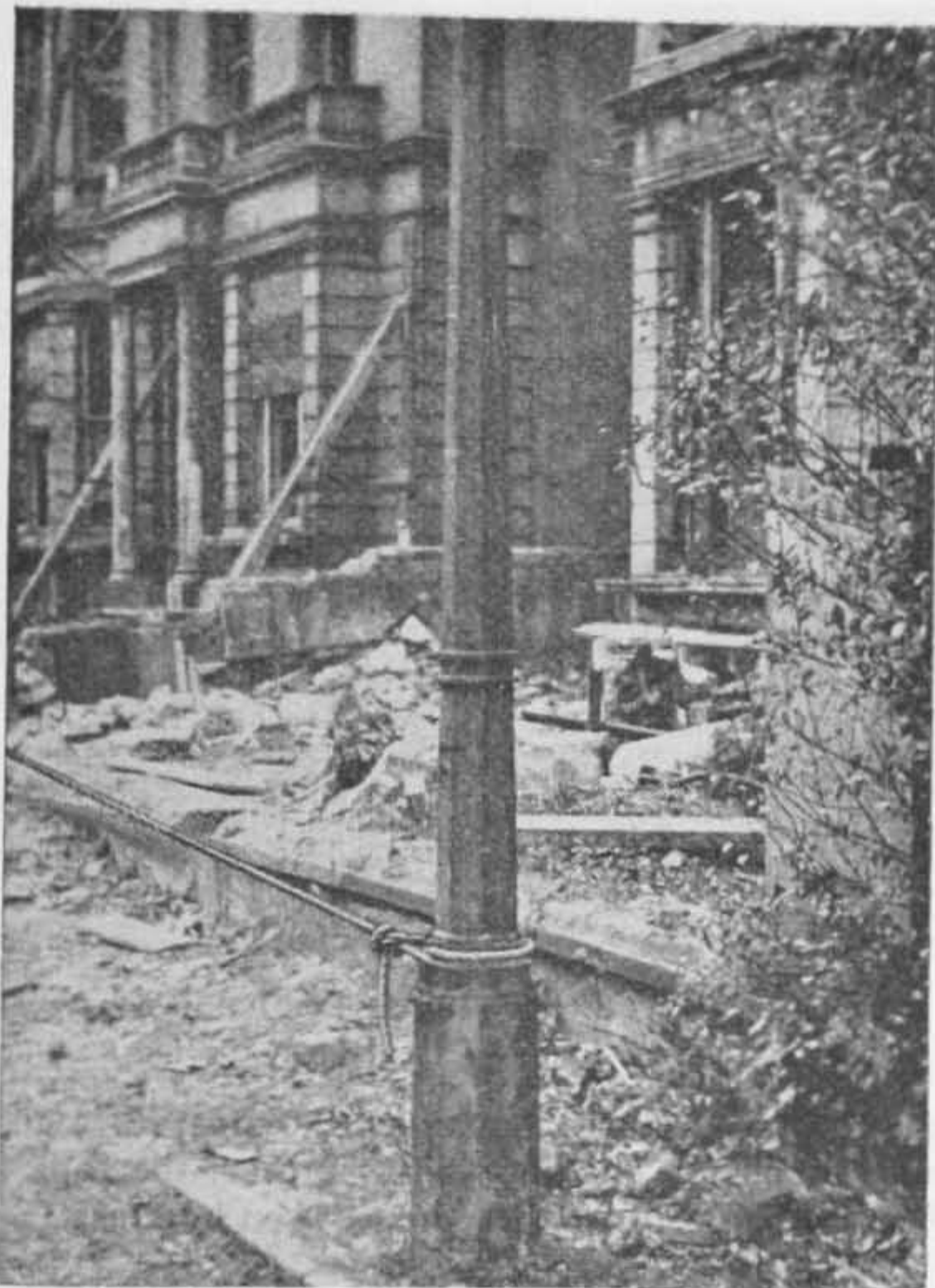

Fig. 89 (c). Improved holdfasts

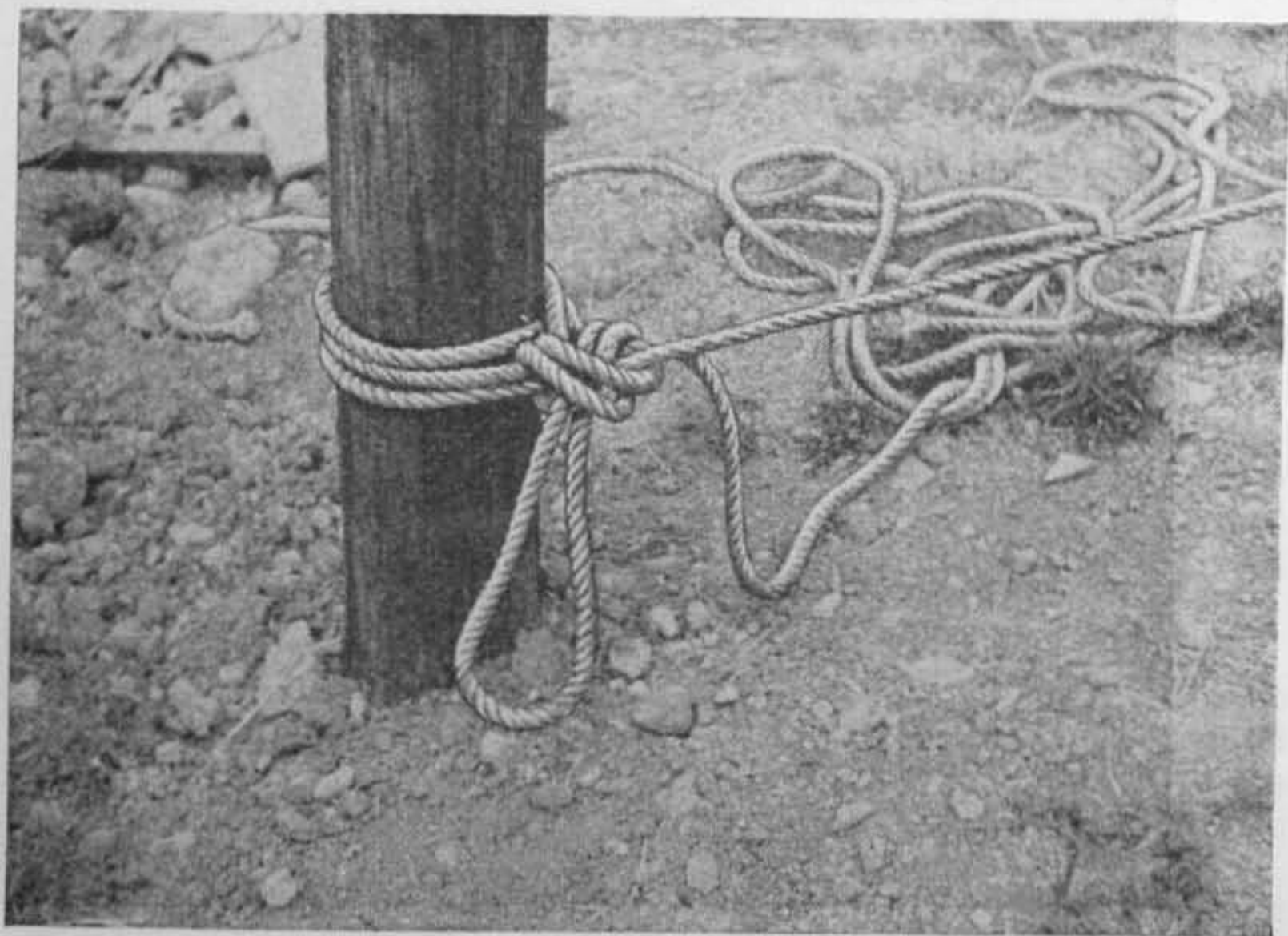

Fig. 89 (d). Improved holdfasts

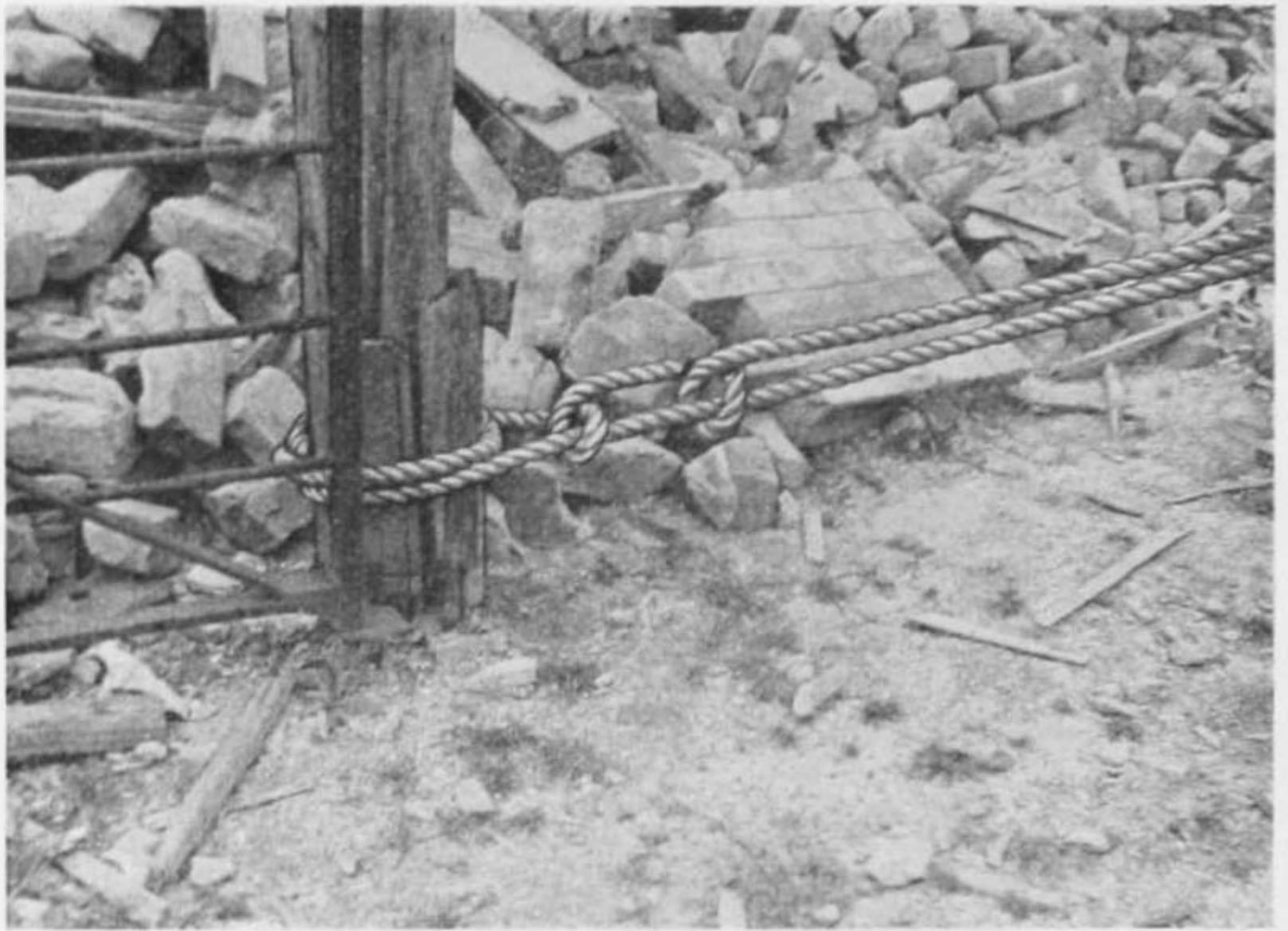

Fig. 89 (e). Improved holdfasts

established tree also forms an excellent holdfast for a guy, and usually will need no packing or wrapping to protect the rope from damage. Fig. 89 (c) to (f) illustrates these improvised holdfasts.



Fig. 89 (f). Improved holdfasts

## CHAPTER 22

### Improvised derricks and sheer legs

- 22.1** The use of derricks, sheer legs and jibs in conjunction with tackle for lifting and lowering heavy weights has been standardised for many years, but now that the blocks and 3 in. ropes have been replaced by the hauling and lifting machine, (see Chapter 24) and poles formerly used in the erection of such apparatus will not be carried forward, improvisation will have to be resorted to if the use of derricks and sheer legs is necessary.
- 22.2** The construction of suitable spars to take the place of poles in forming derricks, sheer legs or jib arms should follow the suggestions for the provision of levers already described in Chapter 10. Timbers of suitable cross-section and length can often be found on the site of operations and, when properly bound together by means of wire bonds, suitably spaced and wedged tight as described, will form improvised spars of the requisite length and sectional area.
- 22.3** A derrick spar can be built up of 4 in.  $\times$  2 in. timbers, laminated if required to the necessary length, and supported when erected by guys, formed of lashing lines fastened to pickets. Three such timbers placed together as described and lashed securely by the wire bonds would form a derrick or stick 6 in.  $\times$  4 in. in cross section, or two rafters of 4 in.  $\times$  2 in. would make up a 4 in. square, the section used depending upon the load to be tackled.
- 22.4** Improvised sheer legs can be built up in a similar manner, or single floor joists of say 7 in.  $\times$  2 in. section of the necessary length can be lashed together, erected, and supported by guy lines.
- 22.5** In choosing timbers on the operational site for use in the formation of derricks, sheer legs or jibs, it is important to ensure, if one-piece joists or rafters are being selected, that they are long enough and strong enough to permit the load to be lifted to the required height after allowance has been made for the length of the snatch block plus the length of the wire sling, the height of the object to be lifted and, with sheer legs, additional allowance for the slope of legs when erected.
- 22.6** When using debris timbers for the construction of built-up spars in the manner suggested, sufficient numbers of timbers should be bound together to obtain the necessary strength, and additional timbers laminated in to provide the requisite length. Care must be exercised in the selection of the timbers to ensure that no splits or fractures are included unless they can be properly secured by additional binding and wedging during the building up of the spar.



Fig. 90. An improvised derrick

### Derricks

- 22.7** A derrick or standing derrick consists of a single spar (or of two or more lashed together for additional strength) with the butt on the ground or on a sole-piece, and the spar held vertical by either three, or preferably four, guys. The weight to be lifted can be raised and moved to the right, left or forward but only to a limited distance.
- 22.8** To support a snatch block and to prevent it from binding on to the derrick, a short crosstree or crosshead about eighteen inches long is fixed to the head of the derrick by means of a square lashing with a wire bond or  $1\frac{1}{2}$  in. rope. The spar should be slightly raised while the crosshead is being lashed into position. Its normal position is  $1\frac{1}{2}$  to 2 feet from the top of the spar but it should be remembered that the lower the crosshead can be lashed, the greater the effective strength of the derrick.
- 22.9** Before the spar is raised into position it will be necessary to attach the guy lines at some point above the crosshead. The 40 feet  $1\frac{1}{2}$  inch lashing lines can be used for this purpose. The two opposite guys are joined together by a reef knot and attached to the spar by a clove hitch. The other two guys are fastened on in a similar manner. When the 100 foot

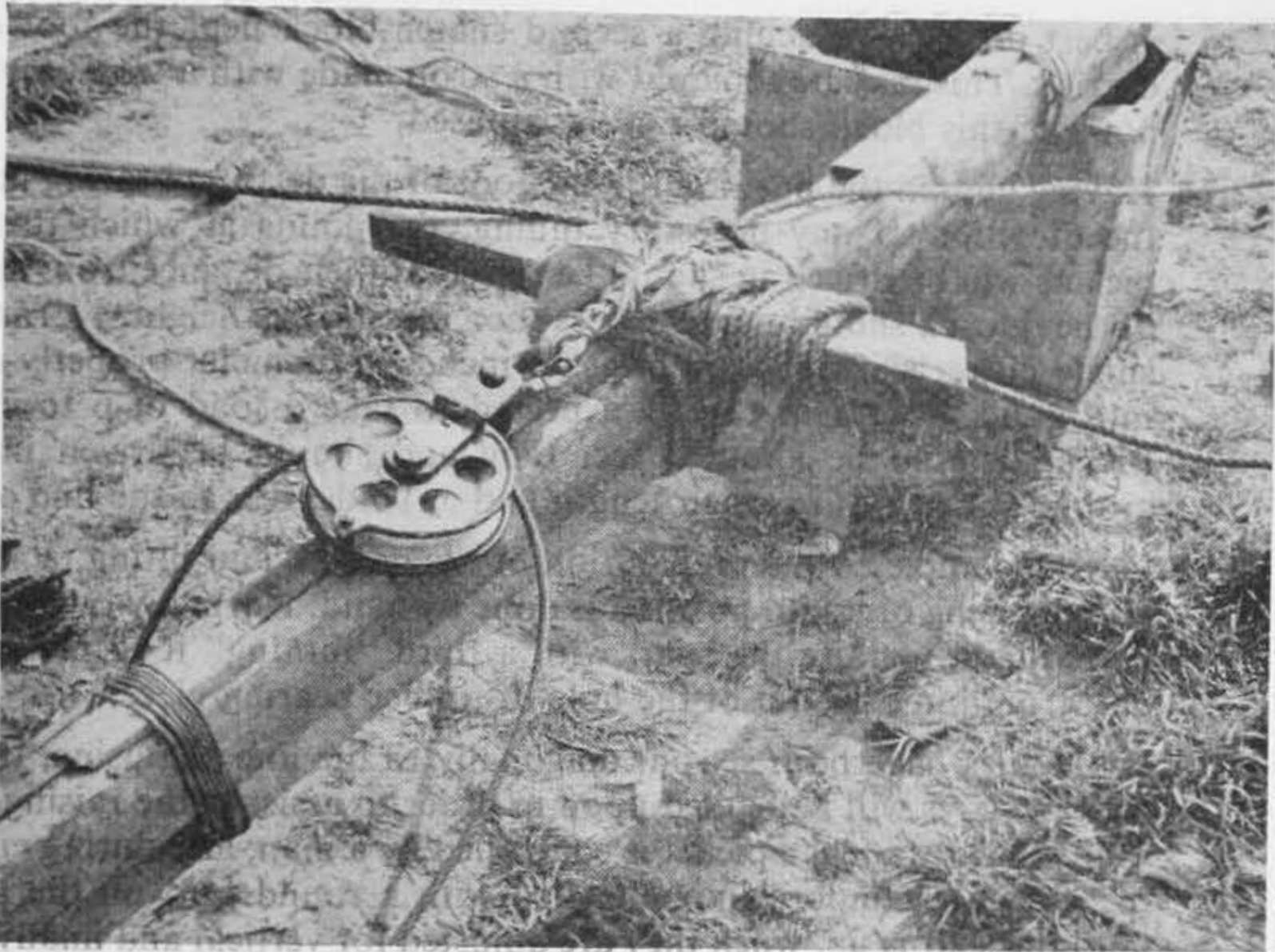

Fig. 91. Head of derrick

2 inch rope is used as a fore and back guy, it should be attached to the spar above the crosshead by means of a clove hitch made in the centre of the rope.

- 22.10** The ground on which the derrick will stand must be firm, or must be made so, and it is advisable to form a shallow hole in which the butt of the spar will be placed. If the ground is too soft to withstand the pressure of the butt, a footing of timber will be necessary in order to spread the load over a sufficiently large area of ground.
- 22.11** The butt should be retained in position on this footing timber by planks or cleats of wood nailed in the form of a square, or, if there is a danger that the side cleats may be too close to the edge of the timber to enable them to be nailed securely, then it is preferable to form a triangular anchorage around the butt of the spar which can be nailed on well away from the edges of the footing timber. This footing should then be sunk flush into the ground to prevent its movement during the raising operation.
- 22.12** A snatch block should be attached to the derrick by means of a wire bond. Alternatively it can be attached by means of a six foot chain over some sacking first wrapped round the spar to protect the lashing. The hook of the chain and the hook of the block should be passed through the ring of the chain, and both hooks moused to prevent disengagement before the load is applied.
- 22.13** To ensure that the pull on the lifting rope shall be transmitted vertically to the block it is necessary to change the direction of the haul, and this

is best done by attaching a second snatch-block near the foot of the derrick. This may be achieved with a strop made with a wire bond. The hook of this block should also be moused.

- 22.14** Having chosen the position for the foot of the derrick, bearing in mind the direction of any necessary luffing, the points at which the guys' pickets will be driven in should be selected; their distance from the foot of the derrick should never be less than its effective height. Normally, a single picket will suffice; if of ash 3 inches in diameter properly driven into good ground, it can be expected to take a load of 6 to 7 cwts. Pickets should be about 5 feet long and should be driven into the ground for two-thirds their length and at 90 degrees to the line of pull.
- 22.15** Having completed the preparation of the derrick and lifting tackle, the initial raising of it into position is done by hand. Normally two men will be required to raise the spar, with a third "footing" it to prevent the butt from jumping out of the hole or timber bearing piece.
- 22.16** If the guys have been set out diagonally to the line of raising, the two forward guys will be hauled upon in order to assist in the raising of the spar. The guy at each picket is controlled by a man, and during erection the guys are temporarily controlled with a round turn on the pickets until the spar is up, when they are adjusted for vertical and finally made fast to the pickets with a round turn and two half hitches.
- 22.17** At this stage of the raising of the derrick, considerable assistance is given by the men controlling the forward guys, who, by hauling, take up most of the load. As the spar approaches the upright position all guys must be under proper control by the men at their respective pickets, who will haul in or take up the slack as required to adjust the derrick to its vertical position before making fast their guys. The leader must check on the upright setting of the derrick and instruct the men on the guys to haul in or slacken off as necessary.
- 22.18** When moving a weight, or raising it or a stretcher over an obstruction such as a wall, it is usually necessary to luff the derrick slightly in the requisite direction. The distance that a weight can be moved is however limited, and is governed by the permissible inclination of the spar. The initial luff should not exceed one fifth of the effective height of the derrick, that is to say if the height from ground to crosshead is 15 feet this would be to a point 3 feet from the base of the spar. This first limit is to allow for stretch in the guy lines when the derrick is first loaded. The maximum luff at any time thereafter must not exceed one-third of the effective height of the derrick, i.e., 5 feet in the case just mentioned. When luffing is being done each guy line must be controlled, and since the men controlling them must work together, the leader must give precise directions to haul or slacken as the direction of the luff may warrant, and must not leave the men on the guys to exercise their own judgment. See Fig. 92.

#### **Sheer legs**

- 22.19** Sheer legs, the second type of weight-lifting apparatus to be described, consist of two spars with their butts on the ground and their tops lashed together forming an inverted "V". When raised into position the spars





Fig. 92. Luffing a derrick

are held up by a fore and a back guy which can be adjusted to permit the sheer legs to lean or luff. Sheer legs can sometimes be employed where the use of a derrick would not be practicable, but they can only be used to move the lifted weight in a straight line by swinging it between the legs.

- 22.20** For a given load, the two spars used for sheer legs may each be lighter than the one required for a single derrick as the load is distributed, but they must be as nearly equal in length and strength as possible. Their butts should be laid flush together on the ground and their tips raised on some sort of support to a convenient height for working. A spacing piece or pieces 2 to 3 inches wide should be inserted between the spars to allow frapping of the round lashing which is used to tie them together, and to permit the spars subsequently to be crossed over one another to form the inverted "V". After the spacing pieces have been removed, the butts of the spars should be crossed over and opened up until their distance apart is equal to about one-third of the lengths from butts to lashing. The space between the spars at the lashing enables the knot to twist during this operation.
- 22.21** The guys are similar to those required and described for the derrick but consist of two only, a fore and a back guy, and in this case the 100 ft. 2 in. rope should be used. They must be made fast to the spars above

the lashing by clove hitches in such a way that they will tend to draw the spars together when the stress is upon the guys, i.e., the fore guy will be attached to the rear spar, and the back guy to the front spar. The length of the guys, as for the derrick, should be sufficient to reach the pickets driven at distances not less than one and a half times the effective height.

22.22 Having completed the lashing and attachment of the guys, a sling or strop, e.g., one of the wire slings or wire bonds or one of the 6 foot chains, should be passed over the fork or crutch. To prevent the sling damaging the rope lashing, a piece of old sacking should be draped over the crutch as protection. The snatch block is then hooked into the

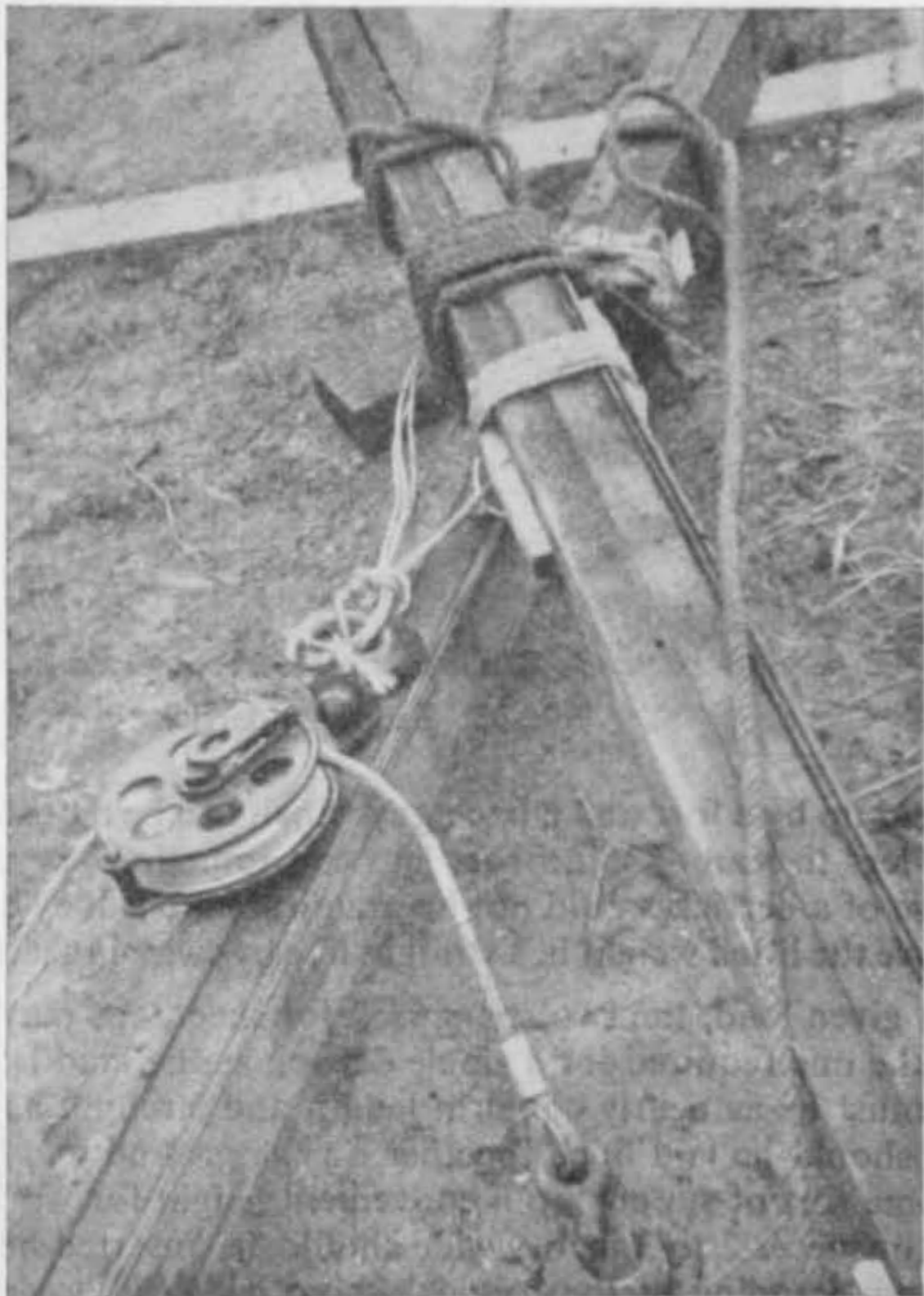

Fig. 93. Improved sheer leg frame, ready for positioning and erection

sling and the hook moused and the hawser of the lifting and pulling machine (see Chapter 24) inserted, the hawser's hook being temporarily lashed to one of the legs pending raising. If it is necessary for a change in direction of the hawser to be made, the second snatch block will have to be lashed to one of the legs just above the ledger, but in some cases the lifting machine itself can be lashed in this position and operated without necessitating the provision of a separate holdfast.

**22.23** To prevent the butts of the spars from spreading apart, a ledger or piece of debris timber should be lashed on near each butt, or as an alternative a 40 foot lashing or wire bond can be used, fastened to each leg by a round turn and two half hitches. Alternatively, holdfasts can be driven in close to each leg and lashed thereto.

**22.24** The initial raising is done by hand under the leaders' direction. The butts are "footed" by two men while the spars are raised by two others. The guys at each picket are controlled by two more men, and as the sheer legs are raised the slack on the fore guy is taken in. During erection the guys are temporarily controlled with a round turn on the pickets, and



**Fig. 94.** Sheer legs erected, load being lifted by hauling and lifting machine

finally made fast with a round turn and two half hitches. The butts must be placed sufficiently far from any obstruction to permit the top of the sheer legs to be luffed over it.

**22.25** A sheer leg is luffed by carefully paying out on one guy and taking in on the other. The amount of luff permissible is similar to that allowed in derricks, i.e., initial luff one-fifth of the effective height, thereafter one-third being the maximum.

### **Safety when luffing the derrick and shears**

- 22.26** When using the equipment suggested in this chapter, the weakest guy in the derrick has a safe working load of  $2\frac{1}{2}$  cwts. The guys in the shears have a safe working load of 4 cwts. The load to be lifted must not exceed the strength of the weakest part of the rig.
- 22.27** As a precaution against slipping whilst under load or when being luffed to swing a load to a desired position, the butts of the timbers, etc., used in the construction of sheer legs or derricks **MUST** be anchored.

### *Methods of anchoring butts*

- 22.28** (a) *In soft ground*  
A base plate or plates of timber or other hard material should be sunk into the ground beneath the butts, which should be lashed to a picket or boxed with timber to prevent slipping. The 3 ft. pinch bars carried by each Rescue Party make suitable pickets.
- (b) *On firm ground*  
The butts should be lashed to pickets (on the inside of the legs where appropriate).
- (c) *On hard surfaces* (e.g. tarmacadam, cinder paths, in which it is impracticable to drive pickets).  
Holes at least 3 inches deep should be cut to position the butts, (the greater the width of the butts the deeper the hole required) with base plates if necessary should the subsoil be soft.
- NOTE:** If the surface should be of concrete, butts should be lashed back to suitable holdfasts.

### *Additional safety precautions*

- 22.29** To ensure sound operation and prevent accidents all men must work in unison under a leader's directions.
- 22.30** All men (with the exception of the operator of the hauling and lifting machine when this is attached to the leg of a rig) must stand clear when a load is being lifted. All men must stand clear when a rig is being luffed; if it is necessary to control the swing of a load this must be done by attaching 40 ft. lashings.

## CHAPTER 23

# Rescue from Heights

### Problems and methods

- 23.1 When buildings are damaged casualties are often marooned above ground floor level. Exactly how casualties on the upper floors of a building can be rescued will largely depend on the results of the reconnaissance made by the rescuer. Rescue from the side of the building which has been damaged by blast may be extremely hazardous if not impossible; the other side of the building may be in a much less dangerous condition and sufficiently sound to permit of casualties being rescued by one or other of the methods described in this chapter.
- 23.2 A normal method will be used as far as possible, even though this demands equipment. The methods which can be adopted may be subdivided into:
- (a) Normal
    - (i) inside—floor to floor.
    - (ii) outside—from windows, etc.
  - (b) Emergency.

### Normal methods

- 23.3 In certain instances where ladders are not available or cannot be used, or where the casualty's condition renders outside methods unsuitable, it may be necessary to use one of the "suspension methods" or snatch block and 2 in. rope inside the building. Use may be made of the stairwell of a damaged staircase, a lift shaft, an existing opening in a floor (which has been caused by damage) or even in some cases a hole cut in a floor large enough to take the stretcher.
- 23.4 When making a new hole in a floor (or enlarging a hole caused by damage to a floor), any cutting necessary should be done near the walls, the centre of the floor being avoided where possible. Floor boards will have to be sawn through, taken up and part of a joist removed, leaving a hole of the required size. The joist should be cut near the supporting wall and not in the centre of the span. The floor boards can be removed with a wrecking bar, and the length of the hole must be parallel to the joists to avoid cutting more than one, as each cut weakens the floor. See Fig. 95.

### *Suspension methods using 40 ft. lashing*

#### *(a) Two-point suspension method*

- 23.5 The two-point method has the advantage that the hole through which to lower the casualty need be little more than the width of a stretcher. There are, however, the usual limitations where tilting a stretcher is concerned, e.g. the casualty's injuries may call for a horizontal position,

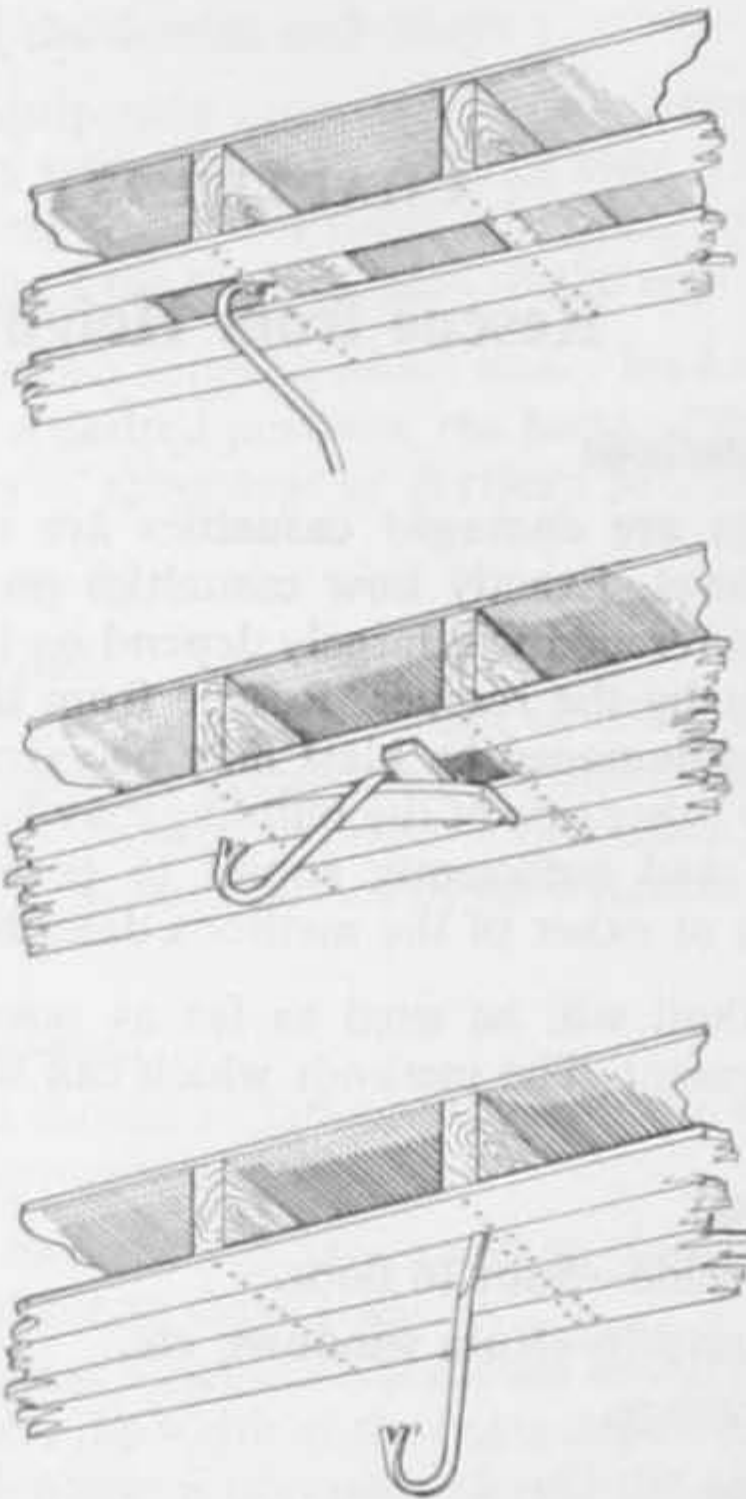

Fig. 95. Uses of wrecking bar

or the injuries may be of such a nature that the rescuers could clearly see danger in adopting this method. (The casualty must be secured to the stretcher by the methods taught in casualty handling.)

- 23.6 Each end of a 40 ft. lashing should be fastened round the wood shaft and through the "D" with a bow-line tied snugly to the shaft, and finished off with a half-hitch on the standing part around the handle (Fig. 96). The stretcher should be carefully passed through the opening, feet first, and lowered slowly, the rope being paid out hand over hand. Two men should be at the lower level to receive the stretcher as it is passed down to them. If the distance is greater than could be accomplished by using a 40 ft. lashing line at the head of the stretcher, two lashing lines will be required, one end of each being fastened to the "D" as before (Fig. 97).

(b) *Four-point suspension method*

- 23.7 Where limitations to the use of the two-point method exist, it will be necessary to employ the four-point method, and the hole in the floor will need to be large enough to take a stretcher in the horizontal position.
- 23.8 With the casualty secured to the stretcher, two 40 ft. lashings should then be fastened, one at each end of the stretcher, each end of the lashing being fastened through the "D" in the manner already described and illustrated in Fig. 96. Two men should normally be on the lower floor

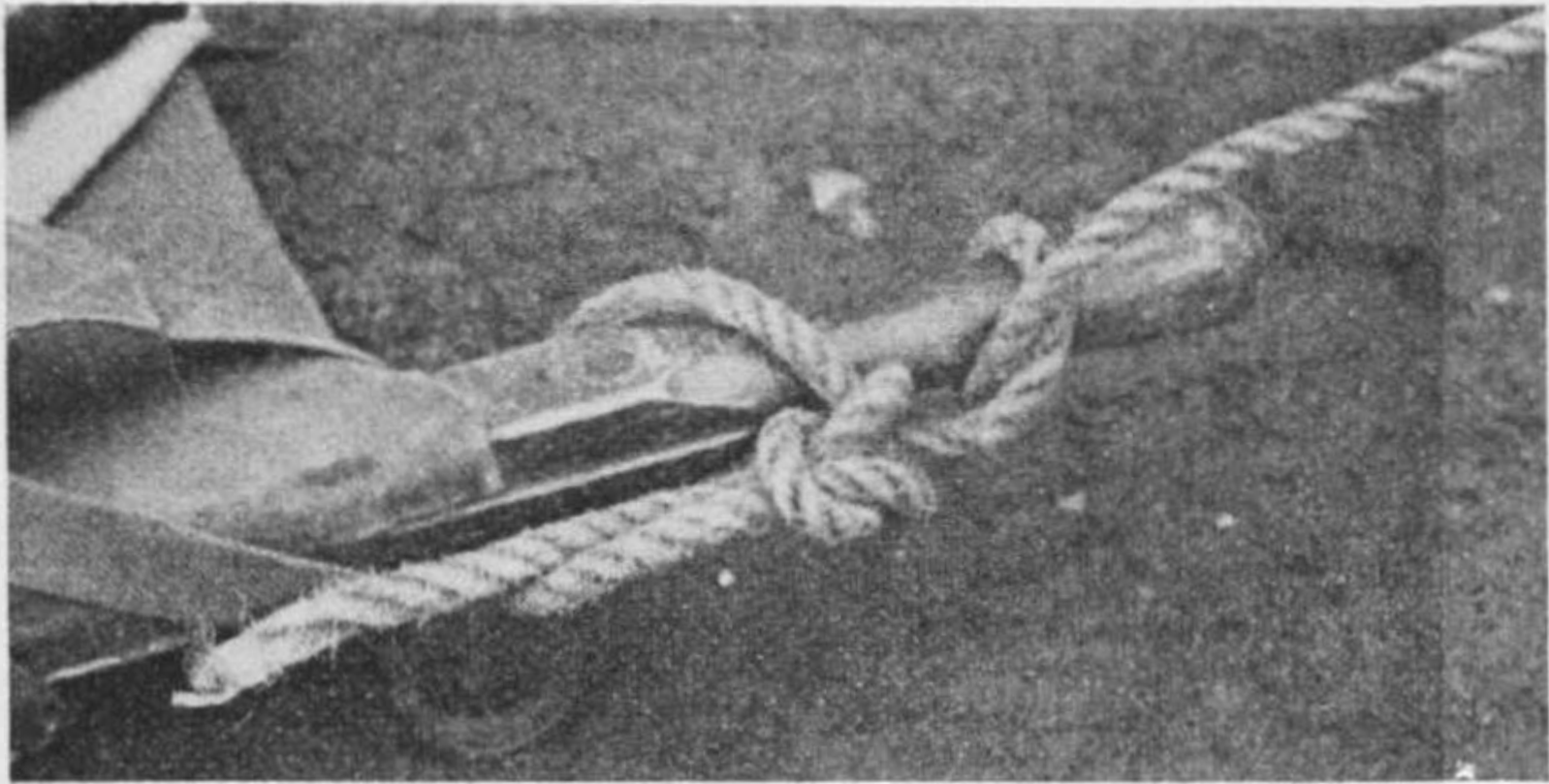

Fig. 96. Correct method of fastening 40 ft. lashing for two-point suspension



Fig. 97. Lowering a stretcher from an upper floor by two-point suspension method



Fig. 98. Lowering a stretcher from an upper floor by the four point suspension method

to receive the stretcher as it is passed down to them. Four men are required for lowering the stretcher when this method is employed, one person manning each lashing at the corners of the stretcher. The stretcher is lowered by carefully paying out the 40 ft. lashings hand over hand so that the stretcher is kept steady. Normally the stretcher should be kept in the horizontal position but the head of the casualty can, if desirable, be kept higher than his feet, depending upon the nature of his injuries.

- 23.9** If the distance is greater than could be accomplished by using a 40 ft. lashing at each end of the stretcher, four lashings will be required, one end of each lashing being fastened to a "D" as previously described.

*Lowering by 2 in. rope and snatch block*

*(a) Inside a building*

- 23.10** In some circumstances it is possible to lower a stretcher by means of the 2 in. rope and snatch block if a suitable place from which to suspend the block can be found, or safe improvisation can be resorted to.

*(b) Outside a building*

- 23.11** A jib arm may be positioned to receive the snatch block. If the jib is decided upon, care must be observed both in respect of the jib itself and the structure from which it derives its support. The actual method of supporting or arranging the jib necessarily depends on prevailing conditions.



**23.12** Wherever possible the jib should be erected on the floor above the one from which the rescue has to be made; this avoids crowding and gives better conditions for raising or lowering and for control. Where this is impossible, the jib will have to be placed in position as high as possible on sheer legs or other supports to give sufficient working height, especially if a stretcher has to be passed out and lowered.

**23.13** The jib may be positioned in one of the following ways:

- (i) It may be projected over a sill or coping, resting on a piece of timber to spread the load, the jib being kept in position by pads or blocks of timber at either side and the tail end made secure. In this case a window on the floor above that on which the casualty rests would be selected for the positioning of the jib.
- (ii) If the jib is to be erected on the top floor of a building it may be possible to pass the jib over the wall-plate, through the rafters, and to lash it securely to the ceiling joists, some method then being adopted for fastening down the tail end of the jib.
- (iii) If the jib has to be erected on the same floor as the casualty, it may be arranged to rest on a pair of sheerlegs erected just inside the window or opening, the feet of the sheers being spread wide enough apart to allow a stretcher to travel through. The feet of the sheers must rest on or be fixed to a sole-plate and prevented from spreading, and the tail end of the jib made secure. As an alternative it might be possible in some cases to lash the jib to the joists of the floor above.
- (iv) By erecting a sheers on the floor above that from which the casualty is to be removed, in which case the feet of the sheers need not be too widely spaced. The feet of the sheers and the tail of the jib must both be made secure as already described.
- (v) On concrete floors a deal or floor joist can be placed across the jib tail, and something piled on the tail to counterbalance the weight of the tackle, stretcher and casualty. It is important that the weight on the tail should more than counter-balance all of these.

#### *Notes*

- 23.14**
- (i) Two sound joists 4 in.  $\times$  2 in. used together or similar sized timber to form the jib are suitable.
  - (ii) The butt end should be at the overhang, i.e. projecting beyond the point on which the jib rests.
  - (iii) The overhang from the support to the end of the butt should be about 2 ft. to 3 ft.

- (iv) The snatch block should be securely lashed to the jib at a point about 6 in. from the butt by the following method. Using the personal cord, commence with a clove hitch on the spar, leaving a short end which is then married; take two or three round turns around the hook of the block and the spar, working towards the butt, frap between the hook and the spar, and finish off with a clove hitch on the pole.
- (v) Care must always be taken that the 2 in. rope is sufficiently manned, at least three men normally being necessary. In some instances it might be advisable to ease the strain by taking a round turn horizontally around a suitable object. Always test the rig before attaching the casualty.
- (vi) Guide lines fastened to the "D's" of the stretcher, at both ends of that side of the stretcher which will be furthest away from the building, are required to keep the stretcher clear of any projections, etc., during its descent. The method of fastening these guide lines is as already described. A pulley and a two inch rope can be used in conjunction with a jib for lowering a non-stretcher case by means of the chair knot (see Chapter 14, "Knots").

*The ladder hinge method (for rescue from first floor windows only)*

- 23.15 It is possible to carry out this operation with four men as follows. The ladder is placed vertically against the face of the wall or building from which it is intended to lower the casualty with the reinforcing wires to the wall as in normal practice. At a height of about 12 inches above the window opening an iron bar, pickshaft or strong rod should be tied to the ladder by means of a 40 ft. lashing line, working from the middle so that the two ends are free.
- 23.16 The casualty should be secured to the stretcher in the normal manner, and the stretcher lifted and placed into position so that the handles at the front end rest on the iron bar or pickshaft. Both "D's" should be hinged at the end of the stretcher to the tie-rod at each side of the ladder, using appropriate free ends of 40 ft. lashing (see above). The two left over ends may be used as guides during the lowering operation. Guide lines are fastened to the stretcher as described in the two-point method (paragraphs 23.5 and 6).
- 23.17 The casualty is then ready to be lowered to the ground, the operation being performed as follows:

Nos. 1 and 2 stand at the foot of the ladder, facing it, with their hands gripping the sides of the ladder. As the lowering commences, they walk slowly backwards in the normal manner of lowering a ladder, allowing it to fall at an angle, the foot being hard against the base of the wall, which forms the fulcrum point. Nos. 3 and 4

at the rear end of the stretcher pass the casualty out through the window, but before passing the end of the stretcher beyond the wall, take the weight on to the two guide ropes and allow the stretcher to ride out clear of the window opening.

**23.18** Lowering is continued evenly, keeping the stretcher horizontal, until the ladder lies on the ground with the stretcher on top of it. If necessary, the two guide ropes hanging from the tie-rod can be manned during the lowering operation to prevent any sway. Two short ladders coupled are suitable for this operation provided they extend sufficiently above the window opening to enable the tie bar to be secured to it.

#### *Improvised ladder hinge*

**23.19** If a ladder is not immediately available, the principles of the ladder hinge method can be applied by utilising materials that would normally be available on a damaged site. Two of the most simple methods are as follows:

- (i) Obtain a length of sound timber at least 4 in.  $\times$  2 in. in section, long enough to reach the required height. At approximately 12 in. above the window sill, lash a cross head approximately 3 ft. long and 3 in.  $\times$  2 in. in section at right angles by means of a square lashing. The stretcher should be fastened by taking the centre of a 40 ft. lashing, making a clove hitch on either side of the cross head, then taking each end of the rope to the stretcher, fastening off by means of a clove hitch on the "D's"—Figure 99 (a).

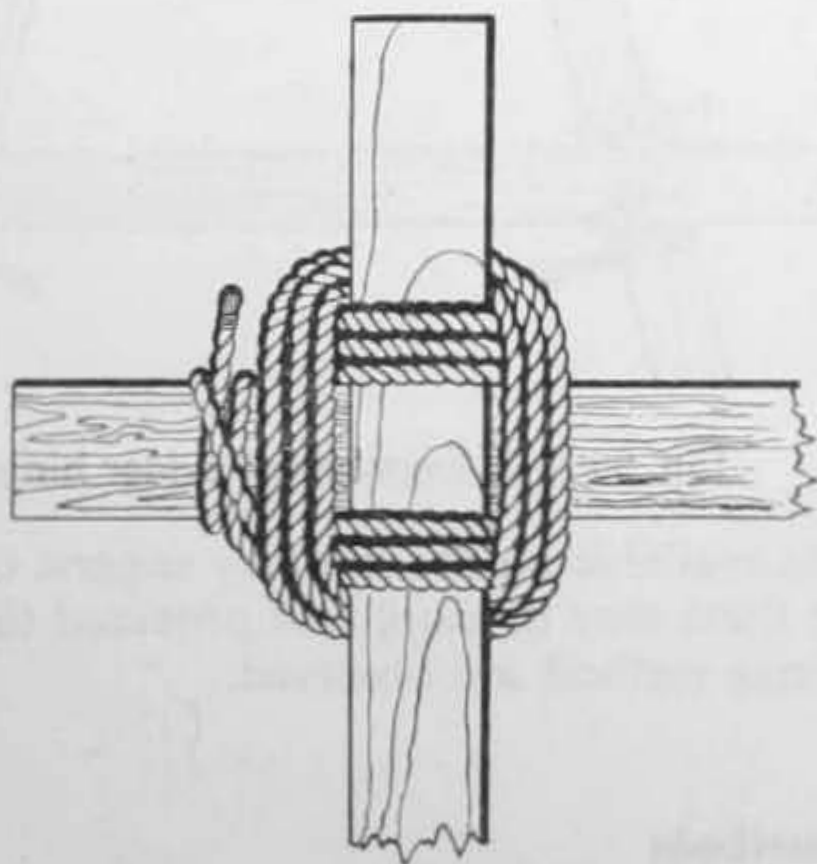

Fig. 99 (a). Improvised ladder hinge

- (ii) Obtain two lengths of sound timber at least 4 in.  $\times$  2 in. in section, long enough to reach the desired height. Lay them in the position shown in Fig. 99(b), and fasten the top by means of a round lashing using a personal cord. At approximately 12 in. above the window sill opening, a cross head should be fastened by means of a series of clove hitches. The cross head should be a piece of timber 3 ft. long, 3 in.  $\times$  2 in. in section. Taking the centre of a 40 ft. lashing make a clove hitch on each upright, then another clove hitch diagonally up and outwards taking in both the upright and cross head; a further clove hitch is then made around the upright above the cross head on each side. The ends are then taken to the stretcher and made fast to the "D's" by means of clove hitches.

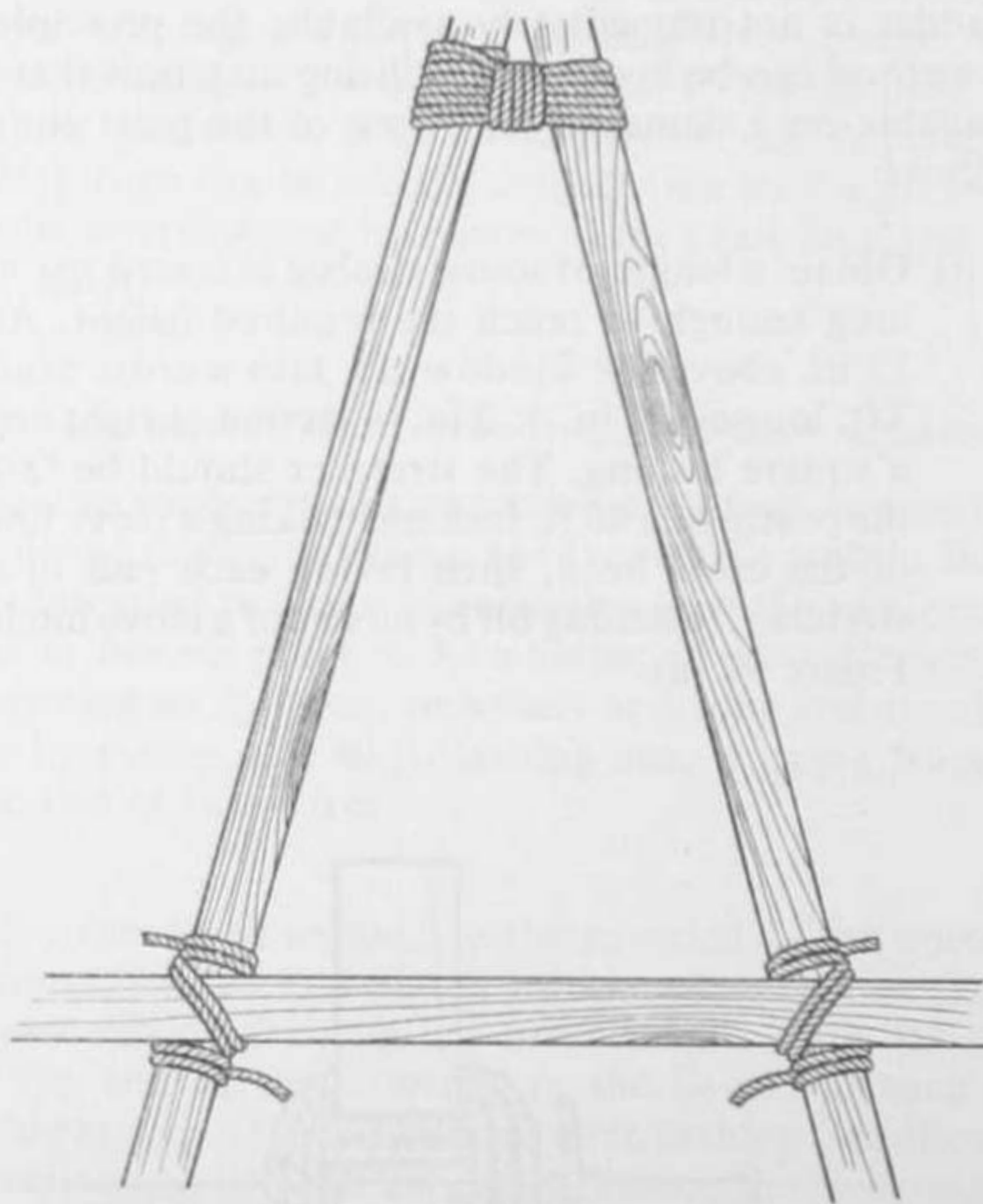

Fig. 99 (b). Improved ladder hinge

- 23.20 The materials available on the site may suggest other variations of this method, and these may be employed provided the overall principles of the ladder hinge method are observed.

#### Emergency methods

- 23.21 For emergency methods which may have to be used under certain circumstances, e.g. crawl, removal downstairs, pick-a-back, etc., see Chapter 12 on emergency methods of casualty handling.

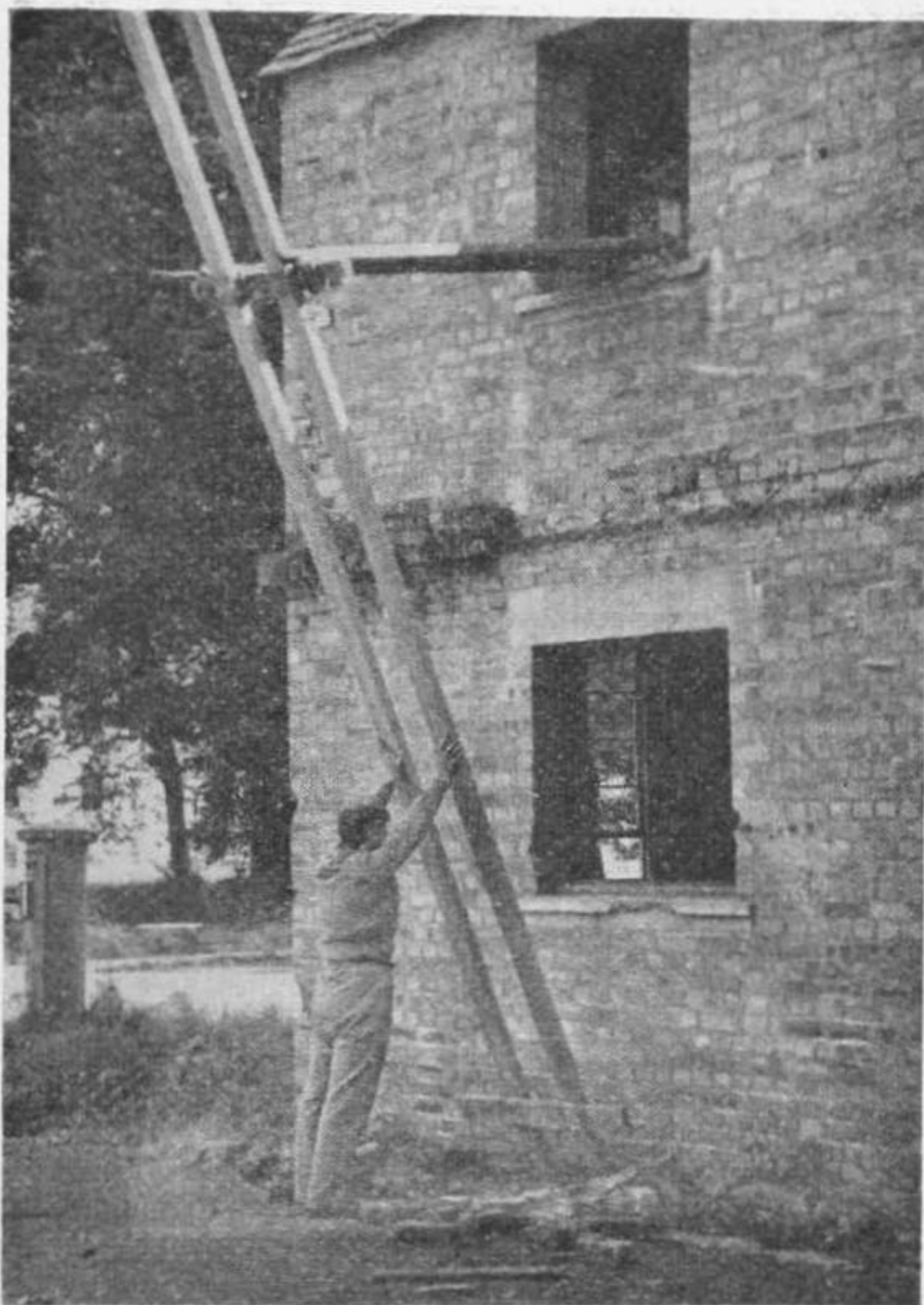

Fig. 99 (c). Another form of improvised ladder hinge

## CHAPTER 24

# Hauling and Lifting Equipment

### Lifting machinery

- 24.1** Until 1958 the equipment available to the Rescue Section for raising or lowering weights or loaded stretchers, or for hauling loads, was the long 3 in. or 2 in. fibre ropes, the 3, 2 or single pulley blocks, used in conjunction with derrick poles or sheer legs, and the pul-lift. With the vast areas of damage likely to result from the explosion of a nuclear weapon over a densely populated region, such heavy equipment could not easily be carried forward from a rescue vehicle over the debris to the scene of rescue operations, without seriously impairing the men's efficiency for their life-saving task.
- 24.2** It became necessary, therefore, to find suitable equipment capable of being carried forward by hand, and yet able to undertake the tasks formerly performed by the blocks and tackle and the pul-lift. The pulling and lifting machine now issued to the Rescue Section amply fulfils this requirement; in fact it is far more versatile and adaptable than the earlier and much more clumsy gear. The appliance consists of a machine or casing through which passes a long steel cable which is attached to the load to be hauled or lifted. The operation of a lever handle backwards and forwards pulls the cable through the machine which, if properly anchored, causes the load to be hauled towards the machine.

### *Description of equipment*

- 24.3** The equipment consists of:
- (a) A pulling and lifting unit complete with a swivel hook to enable it to be secured.
  - (b) A detachable telescopic tubular steel handle for operating the unit.
  - (c) A length of flexible steel wire rope 60 feet long,  $\frac{7}{16}$  in. diameter, fitted with a hook at one end, the other end being tapered and fused.  
This rope is coiled on to a reeler for convenience in carriage.
- 24.4** The machine unit consists of a steel casing enclosing two pairs of automatic jaws which grip the cable passing through the casing. These two pairs of jaws are moved in opposite directions by means of linkage when the handle is operated backwards and forwards. See Fig. 100.

### **Forward and lifting movement**

- 24.5** When the handle is put on the lever at the side of the casing and is moved towards the hook, the pair of jaws fixed to the crank shaft move



Fig. 100. Machine, handle and wire

in the same direction, gripping the cable and carrying it forward. Simultaneously, the other pair of jaws, actuated by connecting rods fitted on the same crank shaft, moves away from the hook, sliding along the cable.

**24.6** When the handle is moved in the opposite direction, the pair of jaws fixed to the crank shaft moves away from the hook, sliding along the cable, while the other pair of jaws moves forward in its turn gripping and carrying the cable in the same direction as before and pushing it through the first pair of jaws in which it slides, and so on. The alternating operation of the handle results in a hauling or lifting movement of the cable of about  $2\frac{3}{4}$  in. for each complete forward and backward stroke of the lever, which with normal operation on a light load results in a travel of about 11 ft. 6 in. per minute.

**24.7** This unit provides a mechanical advantage of 1:43. Its size is 24 in.  $\times$  12 in.  $\times$  6 in. wide and it weighs 39 lbs. Its S.W.L. (safe working load) capacity is: pulling up to 30 cwts., lifting up to 20 cwts.

#### *Reverse or lowering movement*

**24.8** By transferring the operating handle to the lever on the top of the casing, a reversing action is obtained. This passes the cable through the machine in the opposite direction and enables the load to be lowered. The cable is under constant tension while the load is on it and does not jerk or slip during the lowering. Any jerky movement will be due to lack of lubrication, a fault which should be rectified immediately.

### Operating instructions

24.9 The following operating instructions are those issued by the manufacturers of the machine:

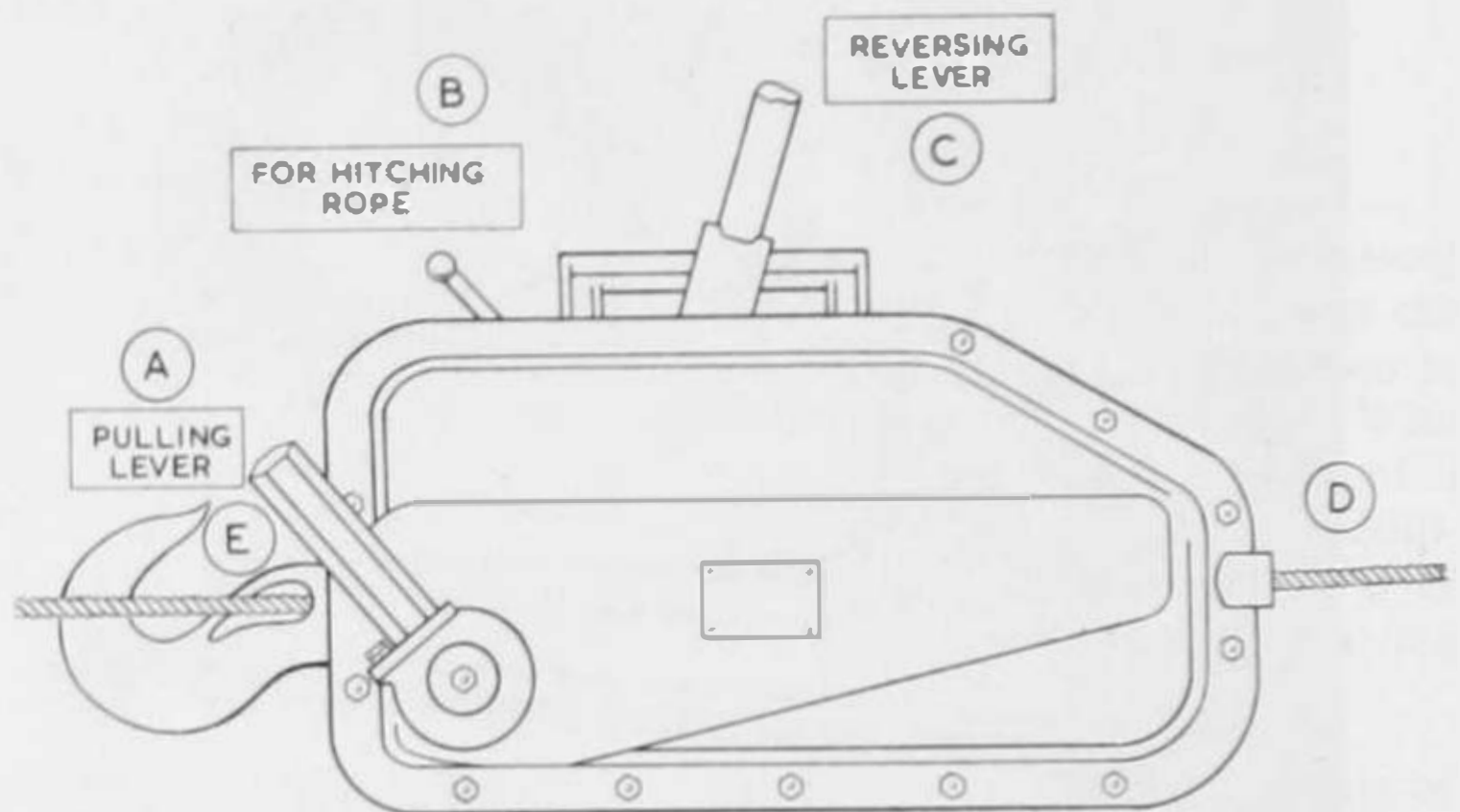

Fig. 101. Operating instructions

- (1) Pull lever "B" firmly towards hook on machine, until it is seated in the notch.
- (2) Push the rope into the machine at "D" until it protrudes through the hole in the hook at "E".
- (3) Pull the rope through the machine until the desired length is reached.
- (4) Place lever "B" back into the operating position—this is done by lifting the lever out of the notch and allowing the spring inside the machine to carry it into its operating position.
- (5) *The rope is now firmly gripped in the jaws of the machine. To pull the rope through the machine, place telescopic operating handle on lever "A" and move it along the direction of the rope. The rope moves through the machine on both forward and backward strokes of the lever.*
- (6) To reverse rope through the machine, remove the telescopic handle from "A" and place it on lever "C" and move it again in the direction of the rope. The rope is paid backwards through the machine on both strokes of the lever.
- (7) To remove rope, pull lever "B" towards hook as in (1) and pull rope through the machine.
- (8) If the operator cannot move the load with the telescopic operating handle fully extended, the load is too great for the machine, and the snatch lock supplied should be used to increase the machine's power.
- (9) Always use slings of sufficient strength to withstand the load.
- (10) Keep the wire rope wound on to the reeler when not in use.



- (11) Never allow any kinks in the rope to enter the machine as this causes internal damage.
- (12) Only use the wire rope supplied with the machine.
- (13) Do not leave the rope release lever (B) in its release position when the machine is not in use as this will shorten the life of the springs.
- (14) Never operate A and C at the same time as this will cause internal strain.
- (15) Never anchor the machine by the tip of the hook, always use a sling.

#### *Lubrication*

- 24.10
- (a) Heavy gear oil should be poured into the slot at the top of the machine. The machine should then be shaken to allow the oil to reach all working parts, the surplus oil being drained off through the rope holes.
  - (b) Oil regularly through the oil holes which are situated on both sides of the lever shaft A.

#### *Maintenance*

24.11 (a) *Before using the machine:*

- (i) Check wire rope to see that it is free of kinks and broken wires. Never use a damaged rope as this jams inside the machine.
- (ii) Put rope in machine and move it to and fro with levers A and B; this movement should be easy and free from jerks.
- (iii) Make sure that the machine is lubricated correctly.

(b) *When using the machine:*

- (i) Should the machine become filled with dirt or dust from the debris it must be immersed in a bath of paraffin and shaken well. This operation must be repeated till the dirt or debris dust is removed. The machine must be well lubricated before use.
- (ii) Should the machine become jammed with small pieces of debris or dust, the casing bolts must be removed and one half of the casing should be lifted off. The debris or dirt can then be scraped out of the machine. When the casing is replaced ensure that the cross bar on the spring tubes always fits properly into the slots on both casings. This can be done by looping a piece of wire round the bar and holding it in position until the bolts are fitted. Ensure that the hook and rope entry guide are fitted. Make sure that all nuts and bolts are replaced and properly tightened.
- (iii) Should the motion become jerky when lowering, this is due to lack of lubrication and the machine should be oiled immediately.

(c) *After using the machine*

- (i) The wire rope must be coiled back on to the rope reeler.

(d) *Examinations at monthly intervals*

- (i) Check for wear or misuse.
- (ii) Make sure that the rope hook is properly fastened on the rope.
- (iii) Measure distance "X" on rope hoop and anchoring hook; if it is more than  $2\frac{3}{4}$  in. the hook has been strained and should be replaced.

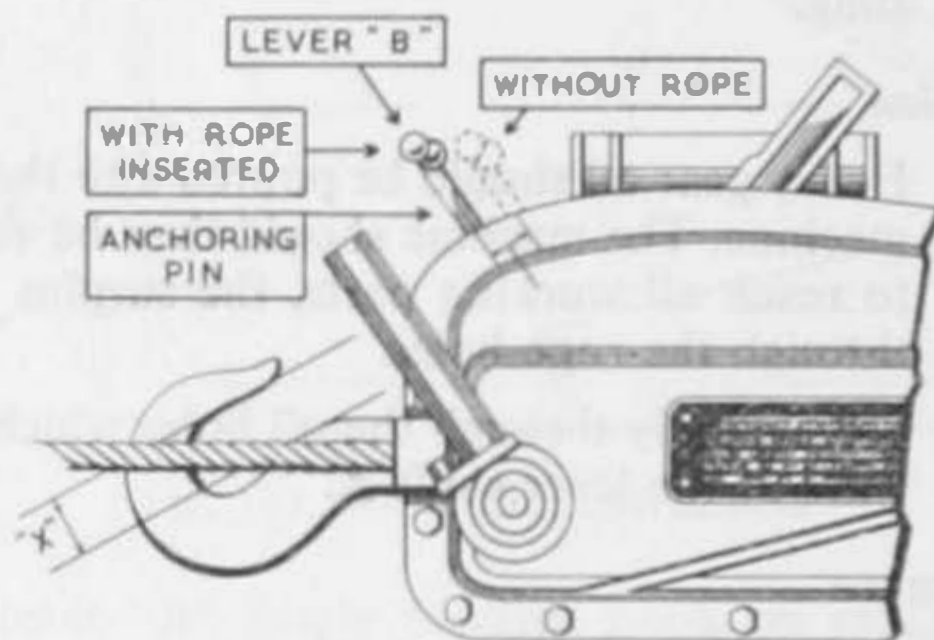

Fig. 102. Monthly check

- (iv) Make sure that the nuts and bolts on the casing are fitted and properly tightened.

(e) *Monthly check on wear of machine jaws*

- (i) Remove wire rope from the machine and let the release lever "B" return to its normal position.
- (ii) Mark this position on the casing.
- (iii) Pull lever "B" forward into its groove, and feed rope into the machine.
- (iv) Return lever "B" to its normal position with the rope in the machine, as though the machine was about to be used.
- (v) Mark the new position of lever "B" on the casing.
- (vi) There will now be two marks on the casing. The distance between these should never be less than  $\frac{1}{2}$  in.; if less it is a sign of excessive wear on the jaws and these should be replaced.

### Snatch blocks

24.12 For use in conjunction with the lifting and hauling machine, special snatch blocks are supplied of diameter to suit the size of the steel cable. These are used principally to change the direction of pull, or to act as a single pulley when raising or lowering a load. Each snatch block weighs 14 lbs. approximately, and two such blocks are carried forward with each machine.

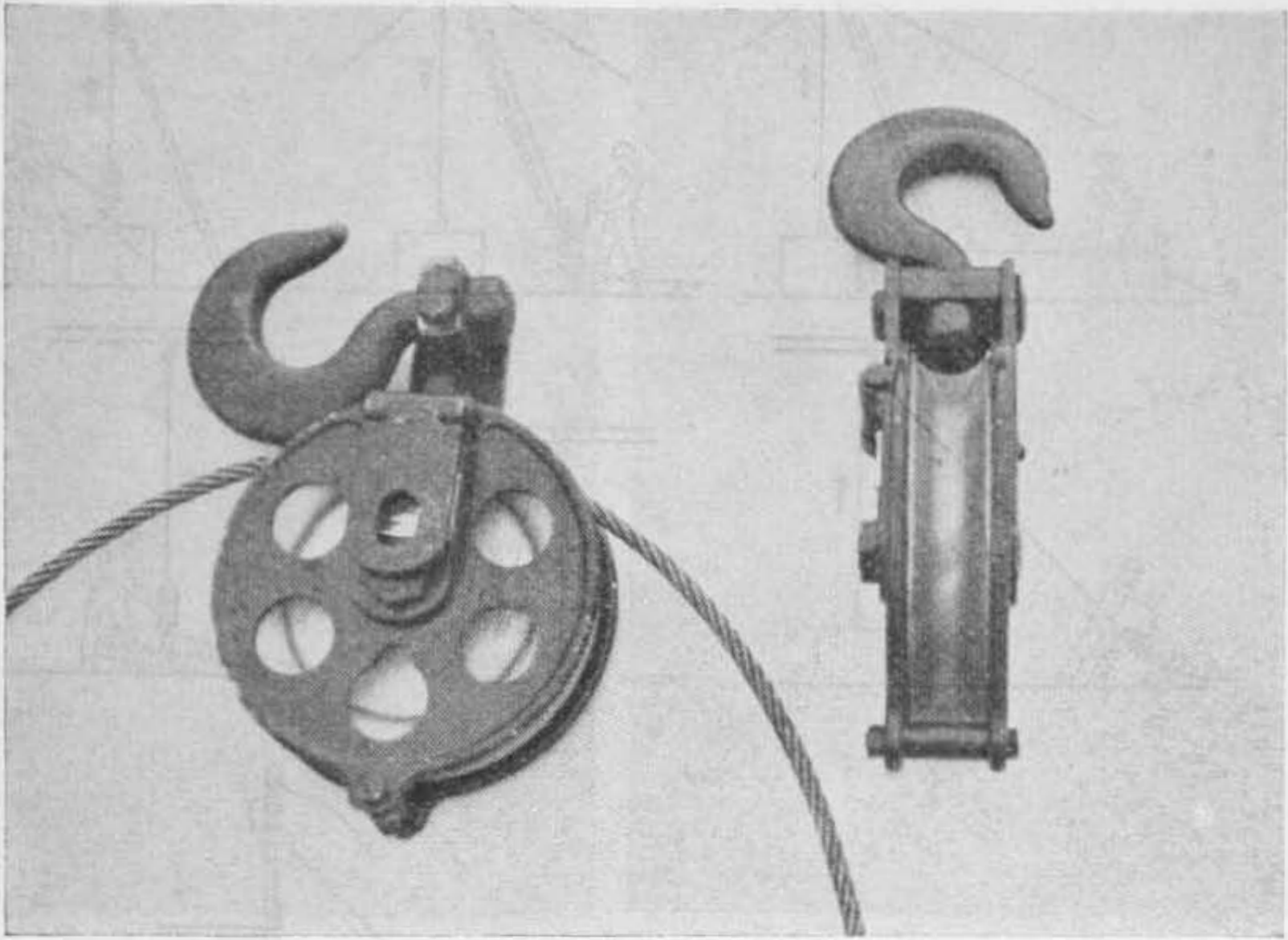

Fig. 103. The new snatch block

*Operational uses*

- 24.13** As a device for lifting or hauling, the machine has innumerable uses and applications. Being light and compact it can be attached to any convenient holdfast or hung from overhead beams, or girders, slung from or attached to derricks or sheer legs, or even attached to the load itself if the cable end is anchored to an immovable object.
- 24.14** The 60 ft. cable enables the load to be lifted, lowered or hauled considerable distances without changing the position of the machine, and in conjunction with the snatch blocks, permits the most convenient position to be selected for fastening the machine, while the rope can be taken over the pulleys, through window or door openings, or down through floors to wherever the load may be. It can also be passed over a block at the head of a derrick or sheers to obtain height for raising loads such as blocks of masonry or for erecting tall poles or posts.
- 24.15** The principles of its application may best be illustrated by the following diagrams on page 158.

*Anchoring the machine*

- 24.16** The efficiency and indeed the safety of all these applications or the hauling and lifting machine depends upon the security of the anchorage or holdfast. This may be anything sufficiently strong or immovable, but it must be firm enough not to show any signs of failure under load.
- 24.17** Secured near the base of stout posts, lamp standards, stanchions, bollards, etc., by means of wire bonds, the machine will be able to haul in its cable and move, lift or lower its load without fear of sudden failure.

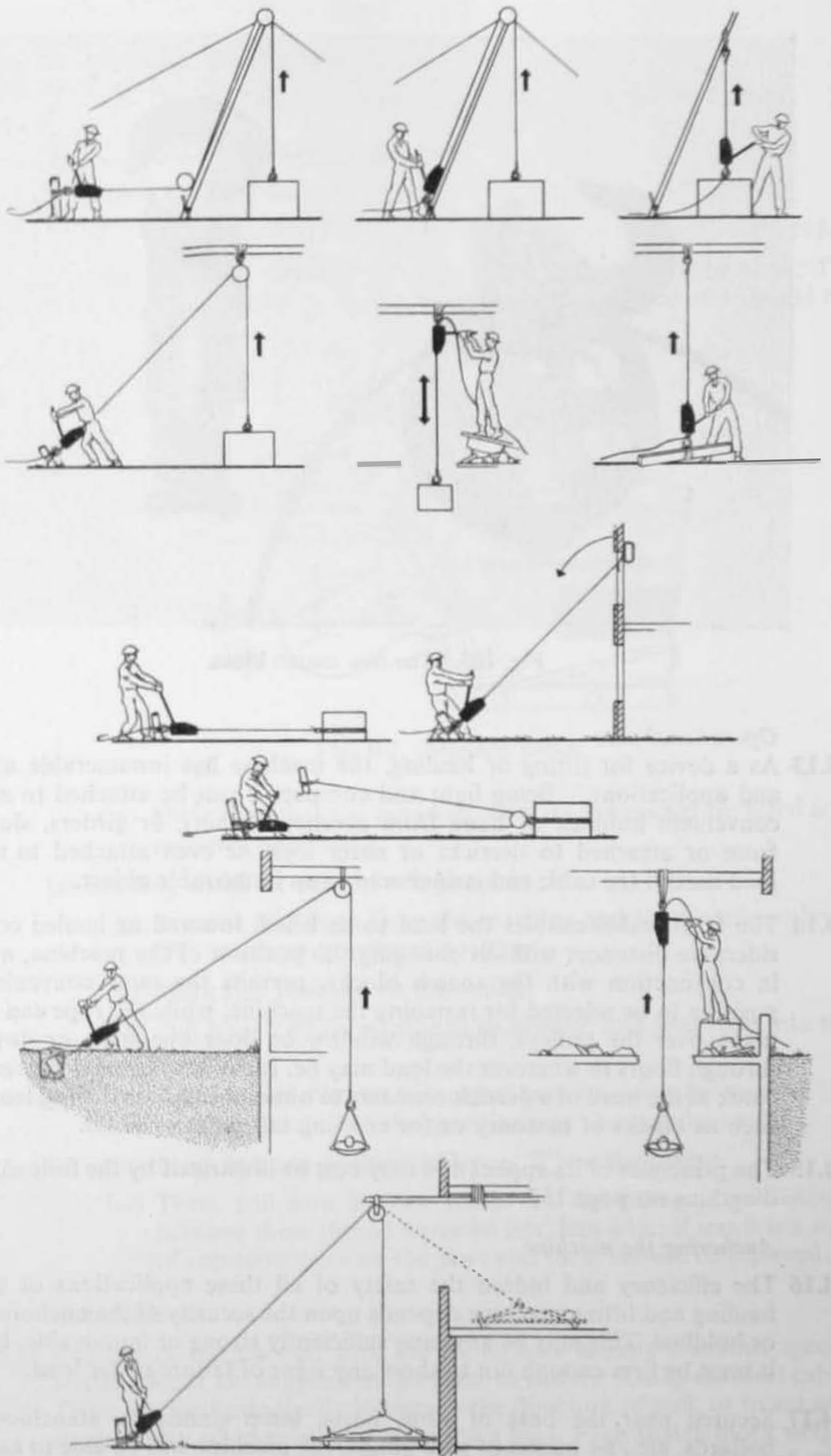

Fig. 104. Principles of application



Fig. 105. Using a piece of debris steel as holdfast

Fig. 106. Attached to base of steel stanchion (note packing protection to wire bond)

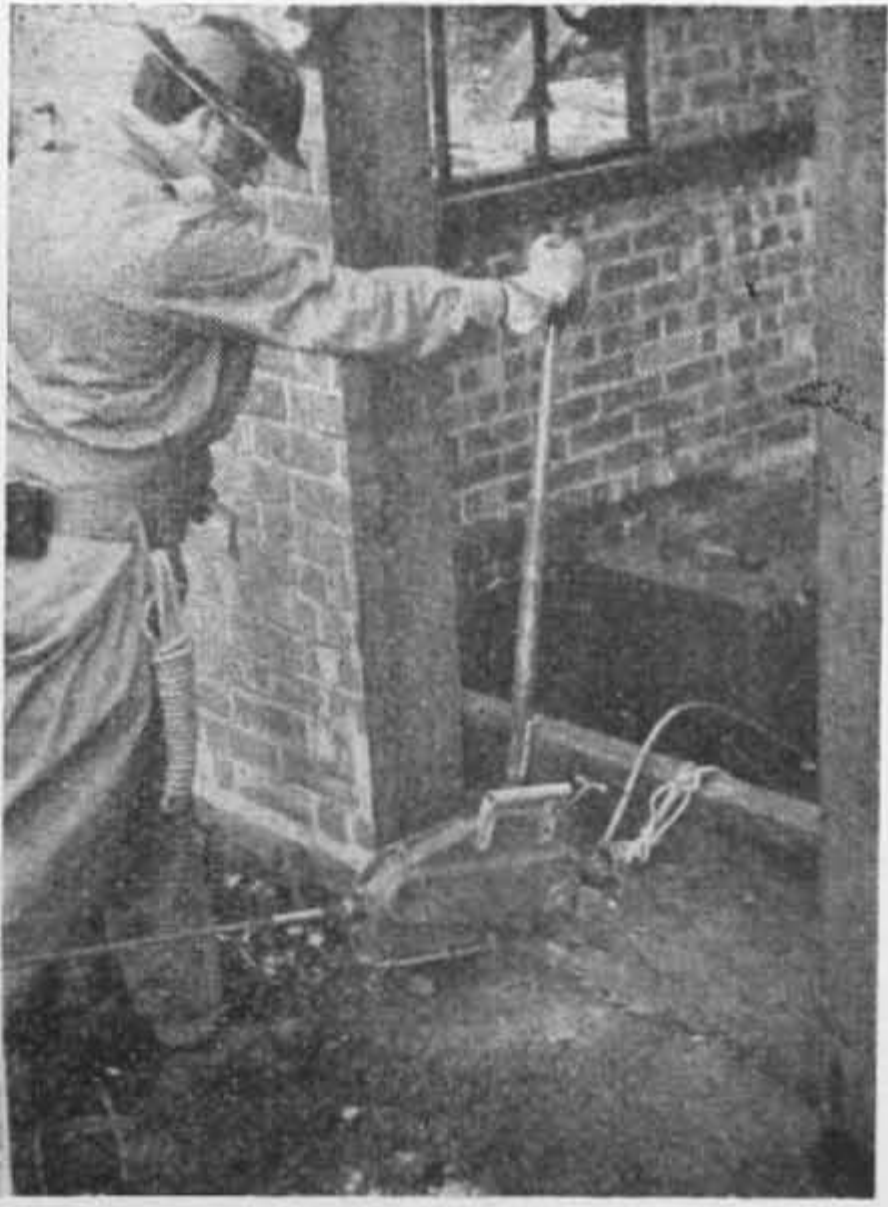

Fig. 107. Attached to base of concrete fence post

Fig. 108. Lashed to timber spreader across door opening



Fig. 109



Fig. 110

Fig. 109. Lowering stretcher through upper floor opening. Machine outside building (on holdfast as in Fig. 105) snatch block lashed to higher floor.

Fig. 110. Lowering stretcher through floor. Machine slung from floor above.



Fig. 111



Fig. 112

Fig. 111. Lowering stretcher from jib arm. Machine attached to holdfast and snatch block to overhanging jib arm.

Fig. 112. Machine lashed to one leg of improvised sheer legs

Lashed to an overhead beam or spreader across joists, it can be operated in basements or between floors. Attached at convenient positions on derricks or sheer legs, fastened to beams or spreaders, across door openings, in road manholes or behind pickets, anchored to strong, improvised holdfasts of crowbars or stakes, the machine will be ready to work as soon as the cable fastened to the load has been passed over any pulleys being used and threaded through the hauling and lifting machine.

*Application of equipment*

**24.18** Applied to rescue operations the systems indicated by the line-diagrams above can be utilised in a great variety of situations depending upon the circumstances prevailing and the problems involved. The following photographs illustrate some of the methods of using the equipment.

## Hydraulic Power Equipment

### Hydraulic equipment

- 25.1 The use of hydraulic power for pumps, rams and numerous lifting appliances has been recognised for many years as being highly efficient and adaptable, and now that portability of rescue equipment has become an important factor, the application of this principle, especially with easily handled transportable equipment, is of the utmost importance in rescue work.
- 25.2 Many life-saving tasks will involve raising heavy loads, prising up collapsed floors to enable entry to be gained, and forcing apart masses of concrete, brickwork or other debris, to facilitate access to casualties trapped within voids. Any equipment used for this work must therefore be portable, sufficiently powerful, and capable of being utilised quickly and efficiently.
- 25.3 The hydraulic jacking equipment now issued to the Rescue Section, when properly positioned and operated, should be capable of carrying out all such lifting and jacking operations normally required in rescue operations. It replaces the heavy 5 ton and 12½ ton ratchet jacks and, being remotely controlled, can mean safer work for both casualty and rescuer. In addition, the equipment is compact and can be inserted into confined spaces and small gaps, enabling a powerful force to be exerted in positions hitherto inaccessible with the larger and heavier gear.

### Description of equipment

- 25.4 The hydraulic equipment issued consists of units comprising a pump (source of power) separated from a ram (power end) by sections of long flexible armoured hose. There are also attachments which can be speedily connected to the master unit enabling various tasks to be performed. The ram works in any position—upright, on its side, upside down or at any angle, and is, in fact, all-directional. Being separated from the pump by the flexible hose, it can be inserted into small spaces and operated from a safe distance or in less confined positions.
- 25.5 The Hydraulic Rescue Kit comprises:
- 2 pumps
  - 4 6 ft. lengths of hose
  - 2 rams 6 ton capacity
  - 2 screwed adaptors for rams
  - 1 wedge spreader
  - 1 alligator spreader
  - 2 rectangular flat base plates
  - 2 ram toes
  - 2 plunger toes



- 25.6 The apparatus is operated by oil pressure from the pump, through one or more lengths of hose, to the ram and its accessories or to the wedge spreader. By this means a lifting or spreading action can be obtained.
- 25.7 The various items comprising the kit can be connected or disconnected by finger operated screw couplers. No tools are required.
- 25.8 Under no circumstances should a coupler be slacked off or disconnected while the set is in use under load. The result would be pressure released, ram plunger collapsed, and oil lost. If for any reason the unloaded ram or wedge spreader is disconnected from the pump before it is fully collapsed, it must be re-connected to the pump before being finally collapsed, otherwise oil will be lost.

### *Pump*

- 25.9 This is a simple hand operated pump which can be used at any angle between horizontal and vertically downwards, that is, with the hose connection pointing downwards. If the pump is allowed to point upwards, the oil will tend to flow away from the valve in the pump thereby preventing the pump from operating satisfactorily.
- 25.10 The pump can be held in one hand and the handle operated by the other, or it can be placed on the ground and steadied during operation by placing one foot on the foot plate attached to the side of the pump body.
- 25.11 On the side of the pump barrel is a release valve fitted with a small hand wheel. When this wheel is turned as far as possible in a clockwise direction the valve is closed and the pump is ready for use; by turning the hand wheel about half a turn in an anticlockwise direction, the valve is opened and the pressure is released. By careful operation of this valve the apparatus can be controlled within very fine limits when lowering.
- 25.12 At the opposite end of the pump barrel to the hose connection is a cheese headed screw to which is attached a dip rod. By means of this dip rod the level of the oil in the pump barrel can be determined. For further details see para. 25.32-36 "Maintenance".

### *Hose*

- 25.13 Each 6 ft. length of hose is fitted with a male coupler at one end and a female coupler at the other. The hose are interchangeable with each other, are pre-charged with oil and ready for immediate use. The oil is retained in the hose by valves in the couplers. A slight seepage of oil takes place as the couplers are engaged and disengaged but this is of no consequence. This loss can be minimised by pulling the couplers apart smartly after the screw has been undone. Great care should be taken to ensure that the inner washers are not displaced or lost.

### *Ram and screwed adaptor*

- 25.14 This is a compact, portable ram, weighing only 5 lbs. but with a capacity to raise a load up to six tons. When closed its overall height is approximately 4½ in. Its extension, i.e. the amount of lift, is approxi-

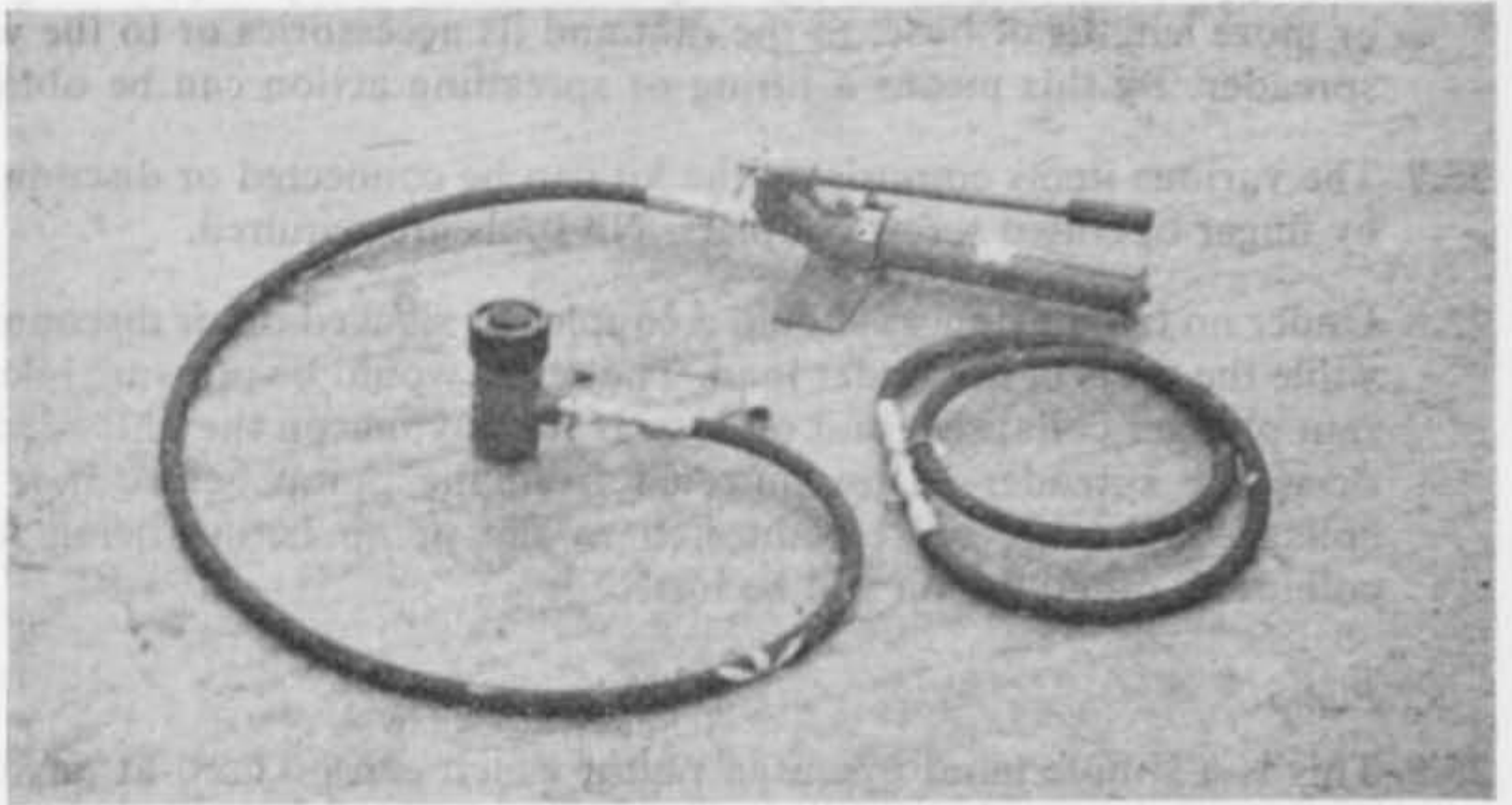

Fig. 113. Pump, hose and 6 ton ram

matchly 2 in. Although this seems a small amount, it is so rapidly operated that, by using the normal procedure of packing as the lift proceeds, fresh bearings may quickly be obtained and a considerable total lift be speedily reached.

- 25.15** The ram is fitted with a finger operated hose coupler. In the top of the ram is a detachable serrated saddle which can be replaced with a screwed adaptor for use with other accessories. The ram body is threaded externally for the attachment of the alligator spreader or ram toe. The ram can be used in any position.

#### *Wedge spreader*

- 25.16** This is an attachment which can be connected to the flexible hose, in lieu of the 6 ton ram, by means of a finger operated coupler. It consists of a pair of hinged wedges which, under hydraulic power, can be forced apart thus exerting a spreading action at the tips of the wedges. Weighing only 4½ lbs. the wedge is small and compact yet can be very useful for commencing to move, lift or spread loads, especially in confined spaces. The tip of the upper wedge is serrated in order to provide a grip and to minimise slipping. When closed, the jaws are approximately ⅝ in. thick at the tips and under power open up to 2½ in. The recommended maximum load at the tip of the jaws is 15 cwt.

#### *Alligator spreader*

- 25.17** This accessory is an enlarged version of the wedge spreader, and requires more available space for its use, and has a much greater range of separation than the wedge spreader.
- 25.18** To assemble the alligator spreader for use, the serrated saddle is removed from the ram, and the alligator spreader is screwed to the ram body. The operation of the alligator spreader is effected direct from the plunger of

the ram. Great care must be taken to see that the push rod of the alligator spreader is kept clean and free from damage, otherwise it will not engage with the plunger of the ram.

**25.19** The maximum load which should be applied to the alligator spreader is 1 ton.

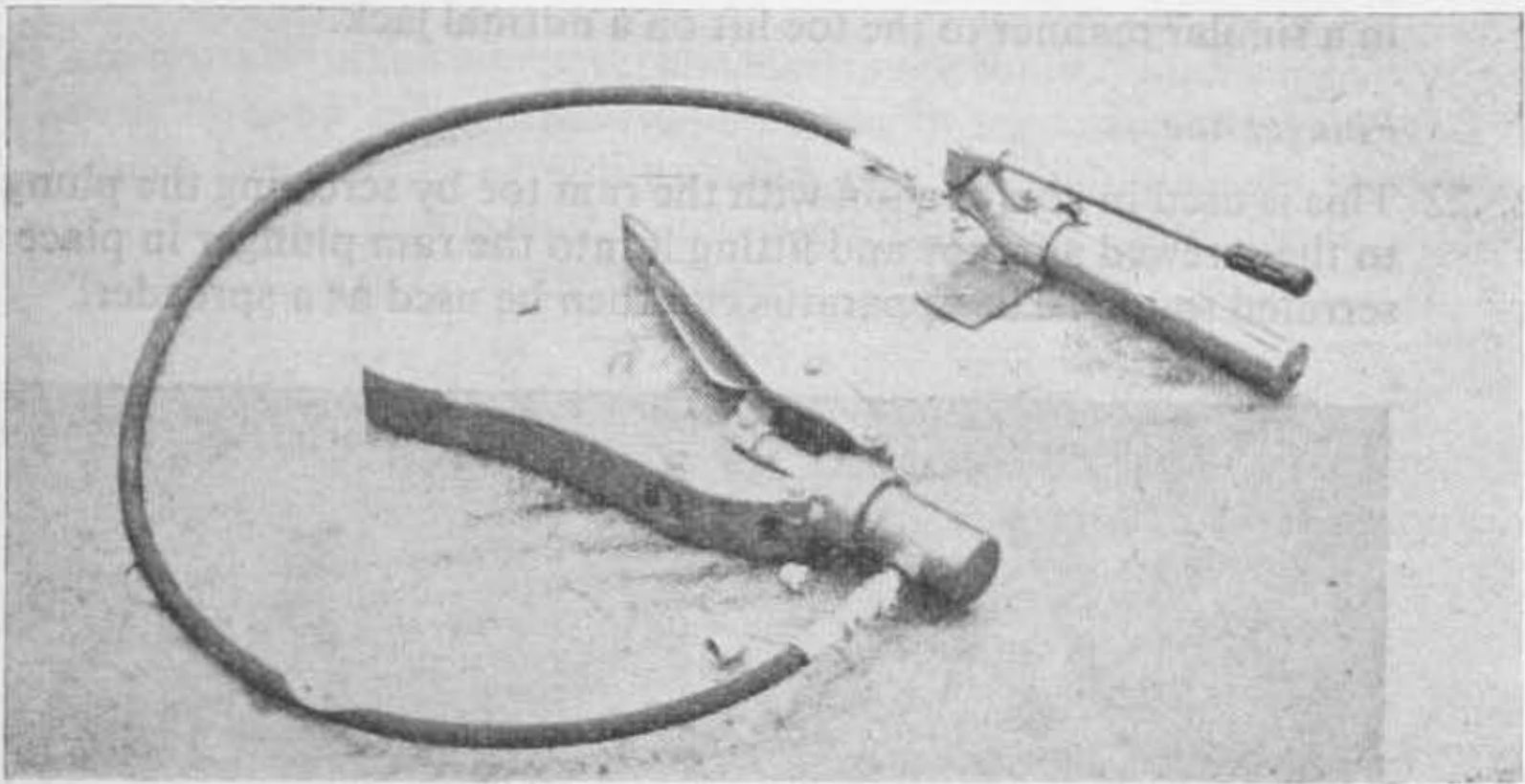

Fig. 114. Assembly of ram and alligator spreader

**25.20** Somewhat heavier than the other parts (about 19 lbs.), it consists of two opening jaws about 15 in. long actuated by the hydraulic ram. When closed it can be inserted into openings only  $1\frac{1}{2}$  in. wide. Under power operation the jaws open or spread to about  $11\frac{3}{4}$  in., enabling loads to be moved sideways or lifted. The maximum load on the tips of the jaws should not exceed 20 cwt. The tips of both jaws are serrated to minimise slipping.

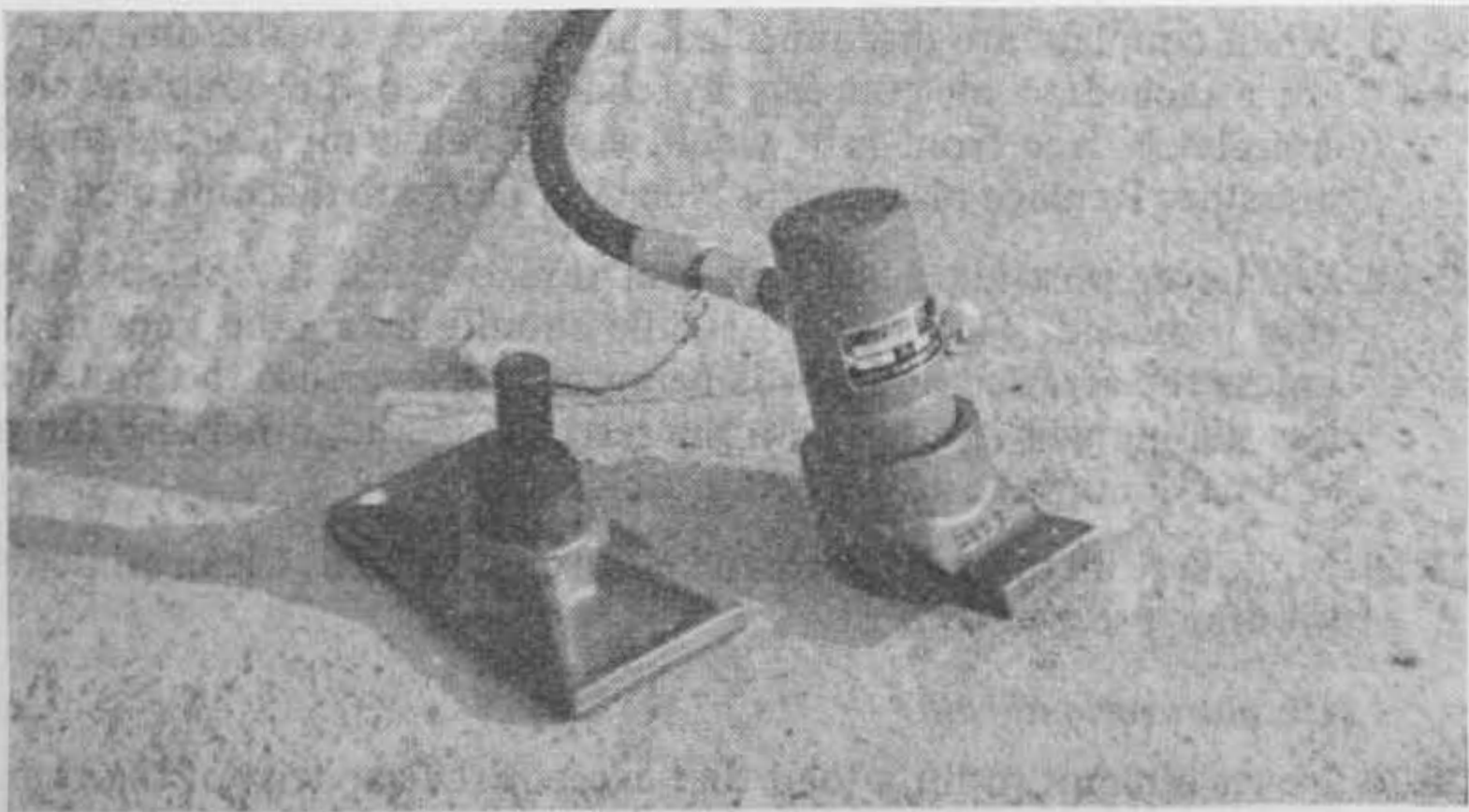

Fig. 115. Assembly of baseplate and ram toe

### *Base plate and ram toe*

- 25.21 The base plate can be fitted by screwing it to the screwed adaptor which is then inserted in the ram plunger of the serrated saddle. The ram toe is screwed on to the body of the ram. By standing the ram on the base plate and placing the ram toe under the load, the apparatus can be used in a similar manner to the toe lift on a normal jack.

### *Plunger toe*

- 25.22 This is used in conjunction with the ram toe by screwing the plunger toe to the screwed adaptor and fitting it into the ram plunger in place of the serrated saddle. The apparatus can then be used as a spreader.



Fig. 116. Assembly of plunger toe and ram toe

### **Protection**

#### *Screw threads and ram plungers*

- 25.23 When couplers are disconnected, always screw on the dust caps which are attached to all couplers by chains. Keep the couplers clean and completely free from grit which would cause oil leakage and loss of pressure. Replace plastic caps when couplers are disconnected.
- 25.24 Whenever possible guard the ram threads with the plastic protecting ring provided. The serrated saddle should always be kept in the ram unless the screwed adaptor is being used. Never use the ram alone unless the plunger is fitted with the serrated saddle, otherwise the plunger will be damaged and rendered useless.
- 25.25 Make sure all threads are clean before engagement. Clean all items of the kit after use.

#### *Do not overload ram*

- 25.26 Never attempt to lift a load that exceeds the capacity of the ram. Overloading causes cracked cylinders, blown cups and bent plungers. Cease pumping as soon as the action requires considerable force, an indication of overloading or maximum extension of the ram.

*Do not over-extend plunger*

- 25.27 Because of the tremendous force of the hydraulic power, it is possible to push the plunger out of the ram. Be extremely careful not to extend the plunger beyond the limit of the engraved markings on the plunger.

*Off-centre loads*

- 25.28 Care must be taken whenever the load is not centred on the ram plunger. Loads will be off centre, for example, when using the ram and/or plunger toes. Pump carefully. When pumping is unusually hard, stop operating and, if possible, re-adjust the load. Off centre loads produce considerable strain on the plunger.

*Care of hose*

- 25.29
- (a) A sharp impact may kink the wire strands on which the strength of the hose depends. Subsequent applications of pressure subject the kinked wires to stresses which eventually cause the hose to break.
  - (b) Never carry or lift any part of the apparatus by means of the hose.
  - (c) Avoid sharp bends. Do not apply pressure from the pump when the line of hose has sharp bends. Always arrange the hose with easy flowing curves.

**General**

*Provide clearance*

- 25.30 Always position the set up so that the hose and couplers have clearance when the ram extends.
- 25.31 *Keep the apparatus away from excessive heat* which tends to melt the wax sizing of the cups and causes leakage. Heat also weakens the structure of the hose.

**Maintenance**

*Blank caps*

- 25.32 Whenever any item of the kit is not in use the blank cap should be screwed on the coupler to protect the valves from dirt and grit.

*The pump*

- 25.33 From time to time the oil level in the pump should be checked. This can be done by holding the pump in a vice in a vertical position with the hose connector downwards, and removing the cheese-headed screw in the top end of the barrel. To this screw is attached a dip rod, and oil should be added, if necessary, to bring the level up to the notch on the rod. Do not overfill as the pump must have sufficient air space to function properly. After checking the oil level be sure the screw is well tightened, otherwise leakage may occur. When checking the oil level, occasionally drain the pump completely and flush out with paraffin, then refill to the notch on the dip rod as referred to above.

### *Type of oil to be used*

- 25.34 Always use a good quality hydraulic jack oil when topping up or refilling the pump. Brake fluid, alcohol, glycerine, and castor oil damage the cups and packings, and should never be used. In cases of extreme emergency, S.A.E. 10 motor engine oil can be used, but should be replaced at the earliest opportunity with a good hydraulic jack oil.

### *Removal of air from the system*

- 25.35 It is possible that air might get into the system, hindering its proper operation. To remove air, close the release valve, and pump until the ram is fully extended, then open the release valve and place the plunger end of the ram on the floor and slowly press down until it is fully collapsed; then close the valve and pump rapidly 8 to 12 strokes. Keep the pump vertical with the hose end downwards. Repeat the procedure if necessary.

### *Accessories*

- 25.36 Apart from keeping all screw threads clean, and oiling the moving parts of the wedge and alligator spreaders, no maintenance is called for.

### *Uses of hydraulic gear in rescue operations*

- 25.37 Being easily transportable over debris, quickly assembled, compact when ready for use, and capable of exerting considerable power, the hydraulic jacking and spreading equipment has many and varying uses in rescue operations. It can be adapted to push, spread or lift loads under all sorts of different and difficult situations. Being remotely controlled it enables the "power-end" of the apparatus to be inserted into a very small space whilst the operator can work in less cramped conditions. There is no limit other than that imposed by the length of the flexible hose, to differing positions of the pump in relation to the ram, which may be higher or lower than the operator, as well as away out in front of him. The comparative short lift or travel can readily be extended by frequent packing and re-siting, whilst an initial gap between tool and load can be filled by timber extensions to enable the ram to exert its pressure.

- 25.38 It is not possible in the space available here, to give a fully comprehensive list of the many uses for the hydraulic outfit, but the following examples of its operation serve as indications of the methods of use and show how it can be adapted to perform a variety of rescue tasks.

### *Use of 6 ton ram for lifting a load*

- 25.39 Fig. 117 shows the equipment assembled and being used to enable a straight-forward lift to be applied by the ram.
- 25.40 As the force can be exerted sideways instead of vertically, this arrangement can be used for spreading or pushing loads. Fig. 118 illustrates a method of using the 6 ton ram to push a load. Utilising a sound wall as a base and using timbers to form an extension to the ram, the distance which the load can be moved can be increased at will.



Fig. 117. A straight-forward lift by the ram

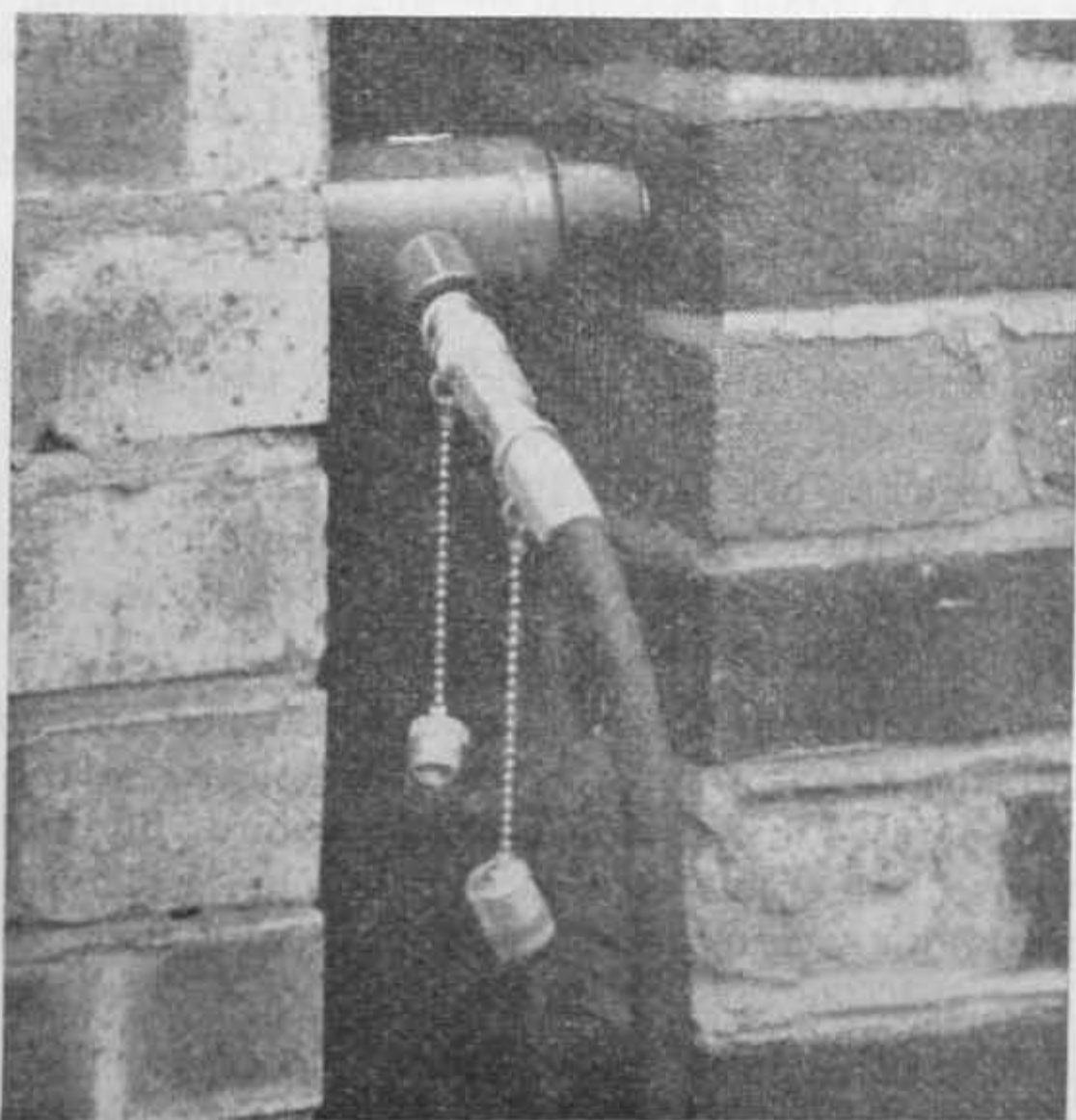

Fig. 118. Pushing a load sideways

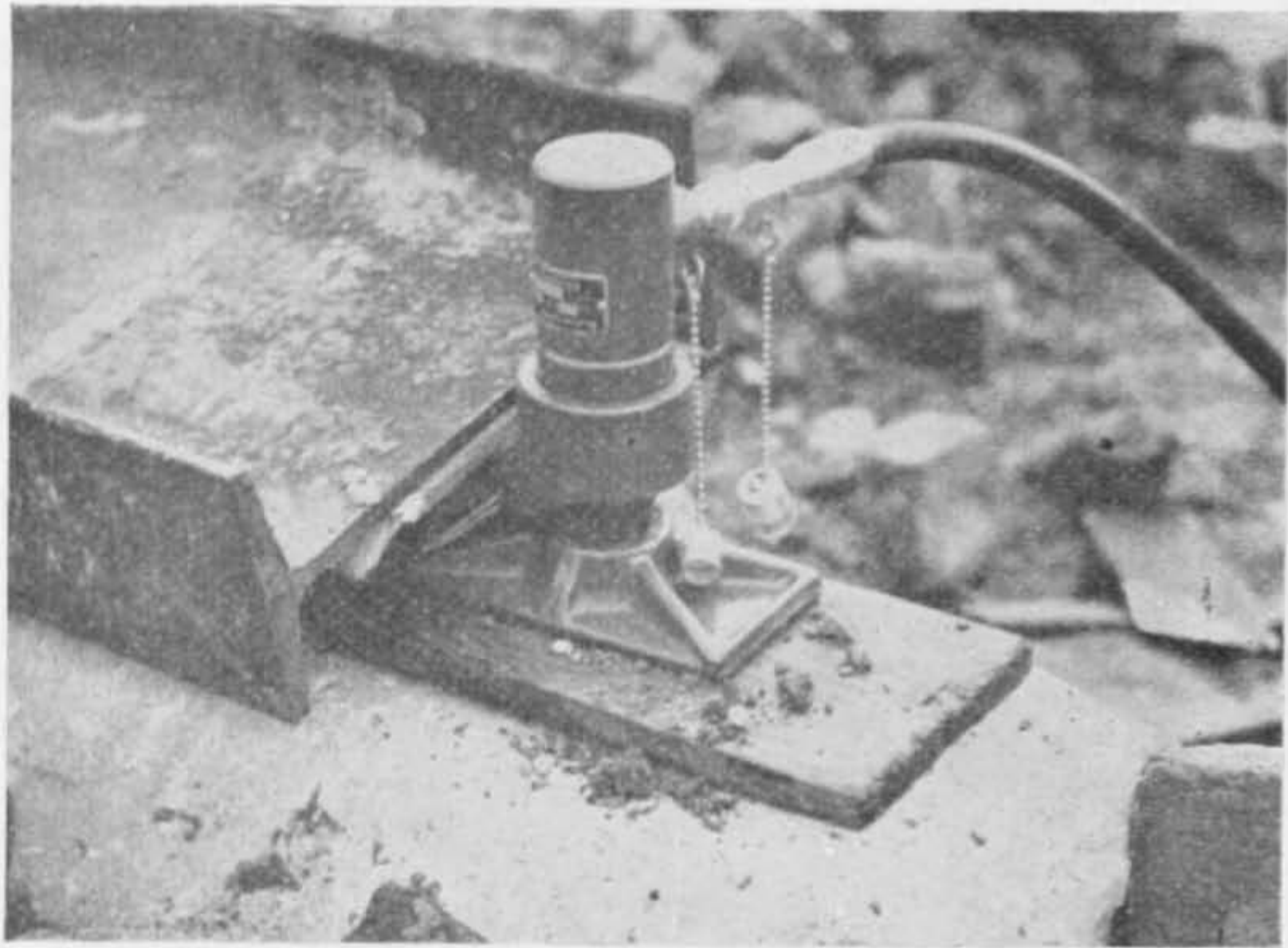

Fig. 119. Initial lift to low load

- 25.41 With the assistance of the baseplate and toe attachments, the 6 ton ram can be used to obtain an initial lift to a low-lying load, too heavy to be lifted by using the wedgie or alligator jaws. The toe can be inserted under as little as  $1\frac{1}{2}$  in. working space and the load can be raised  $2\frac{1}{2}$  in., packed up and another lift commenced. Recommended maximum load on the toe is 3 tons.

*Floor lifting*

- 25.42 The principles of lifting outlined above, can be applied to raising a collapsed floor. It will first be necessary to expose the ends of the joists by clearing away brickwork and rubble to enable a spreader to be inserted to obtain a bearing under three or more joists. With the assistance of the alligator spreader the floor can then be raised to enable initial packing to be inserted as shown in Fig. 120.
- 25.43 As soon as sufficient height has been obtained and adequate packing inserted, the alligator spreader can be replaced by the ram which can then be operated in stages to give the required lift. In the same way in due course both rams can be put into use, spaced apart under the collapsed floor so as to provide a space between them for the entry of the rescuer.
- 25.44 An additional length of timber can be placed over the head of the ram in order to obtain sufficient working height, but this should be kept as short as possible to avoid buckling.

*Use of alligator jaws*

- 25.45 If the tips of the jaws are positioned into a narrow opening and the power applied, heavy weights can be lifted or moved aside with very





Fig. 120. Initial lift by the alligator spreader

little effort. This method enables large portions of masonry to be moved and is particularly useful where there is little working space and where levers cannot be used efficiently. The jaws close to about  $1\frac{1}{2}$  in. and open to approximately  $1\frac{3}{4}$  in.



Fig. 121. Utilising both rams in unison



Fig. 122 (a). Another use of the alligator spreader

25.46 Fig. 122(b) illustrates how a gap can be widened, or a block of masonry moved sideways with the alligator spreader, and the use of timber extension pieces.

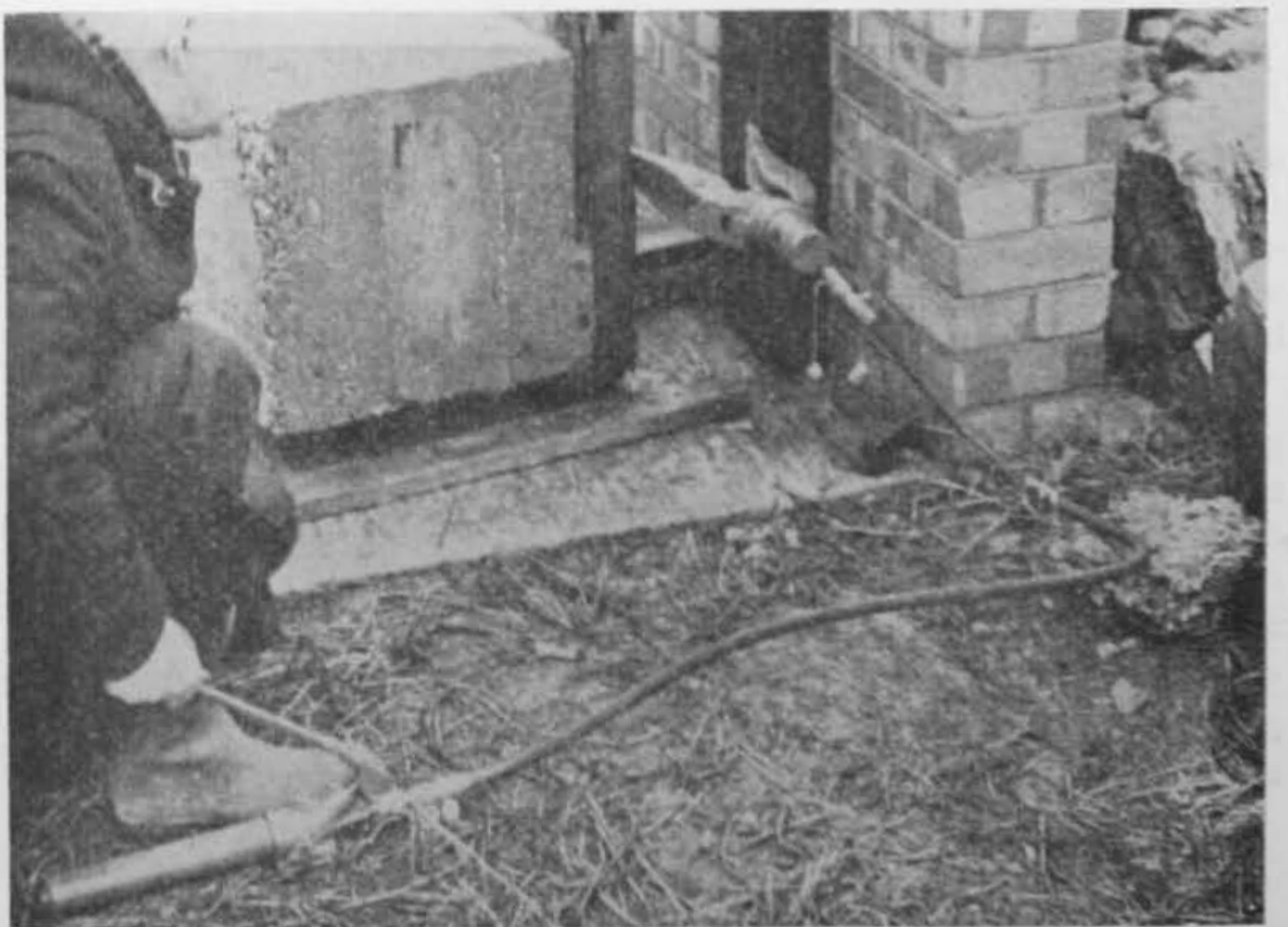

Fig. 122 (b). Another use of the alligator spreader



Fig. 123. The wedgie spreader being inserted under collapsed timber

#### *Use of wedgie*

- 25.47** This diminutive but extremely useful piece of equipment is used in a similar way to the alligator jaws, but even less room is required in which to start the operation. As mentioned earlier, the jaws close to about  $\frac{5}{8}$  in. and open to approximately  $2\frac{5}{16}$  in.
- 25.48** As with the ram and larger jaws, this item can be used in many positions and situations, limited only by the length of the flexible hoses available.

#### **Special features of the hydraulic lifting and pushing apparatus**

- 25.49**
- (a) The entire kit is very portable, and contains attachments which are quickly interchangeable and which adapt the apparatus for use in many different ways enabling a variety of operations to be carried out.
  - (b) The pump permits very selective control and enables the load to be released very smoothly.
  - (c) The flexible hose allows the use of the power tool in situations not normally or easily accessible and, with the additional extension hose fitted, enables the operator to work well away from the actual job.
  - (d) The interlocking quick-release couplings are standard to all connections and enable rapid assembly or change of attachments. The ram works in any position, upright, on its side or upside down, and is a powerful tool.

- (e) The spreading jaws enable heavy blocks of masonry or fallen floors to be moved, requiring only a small space to enable the initial lift or movement to be obtained.

25.50 When using the alligator jaws or wedgie, care must be taken to avoid damage by distortion of the jaws by over-pumping when the load-gap is beyond their limits.



Fig. 124. The apparatus can be operated in a confined space by one man, who can pump with one hand and insert packing as required with the other.

25.51 Although the tips of the jaws are serrated in order to minimise slipping, the normal precautions should be observed when taking a metal-to-metal lift.

25.52 Although maximum safe loads are given, in practice these would be difficult to estimate. If the operation of the pump handle becomes difficult, it is an indication that the load is too great for the equipment. Undue force should not be applied to the handle and under no circumstances should additional leverage be obtained by extending the handle by means of a length of piping.

#### *Packing*

25.53 The normal precaution of "pack-as-you-jack" should always be observed. The timber used at the head of the powerful 6 ton ram should be sound enough to avoid the head of the ram forcing itself into the wood. When the pressure is released to enable the load to settle onto the packing, the ram plunger may not return completely to its seating as it is not spring loaded. If the ram proves difficult to withdraw owing to the base or head having been forced into soft wood packing, levering up the base packing piece by hand or with a wrecking bar will further depress the plunger and make easy the removal of the ram assembly.

## CHAPTER 26

### Temporary Shoring

**26.1** Shoring consists of a series of timbers and fixings arranged in certain forms and positions to strengthen and prevent collapse of any part of a building. In peacc-time, shoring is normally designed and erected to remain in position for some time and is employed when a building has been weakened either by failure of foundations, the removal of former support such as an adjoining building, or from structural weakness that may have occurred.

**26.2** There are three types of shoring in normal use:

- (a) raking shores, used to prevent a wall or upright part of a building from bulging or falling away;
- (b) flying shores, used to support one wall from another across a space;



Fig. 125. Temporary shoring showing propping

(c) dead shores used to carry the vertically dead load of a wall or floor or series of floors.

26.3 The shoring undertaken by rescue parties should normally be limited to that required, firstly, to enable civil defence personnel to carry out their duties with safety, secondly, to prevent further injury to casualties and, thirdly, to obviate danger to the public through the collapse of the damaged building into the highway. It follows therefore that the type of shoring the rescue parties must be prepared to erect during rescue operations should be only such temporary shoring as is necessary to meet urgent requirements. In order that it should perform its function, however, it must follow certain accepted principles as applied to permanent shoring, and the knowledge of what shoring does and how it does it is vitally important to all who may have to erect temporary shoring.

26.4 The materials for improvised and temporary shoring should be obtained from the damaged buildings. Most buildings contain timbers of suitable sizes, especially if two or more pieces are nailed together to form the required lengths and cross sections. Such building up should always be done with the timbers laminated and spiked together with the joints staggered.



Fig. 126. Method of marking

- 26.5** It is useful for the trainee to be able to examine examples of proper shoring and to appreciate the principles involved. For this purpose models of the various types can easily be constructed to scale and studied in detail. Models of similar types carried out in improvised methods and materials would also be valuable aids to trainees.
- 26.6** The purpose of shoring is not to attempt to force the damaged wall or floor back into its original position, but rather to prevent further movement. Any attempt to force things may result in further damage. All shoring should be placed so that it gives support where support is needed, and consequently consideration must always be given to the loads carried by the damaged wall. Usually the wall supports an upper floor or floors and the load imposed by these floors must be reckoned with and, where necessary, transmitted to the shoring and by it to the firm support being utilised.
- 26.7** Fig. 126 illustrates a method of indicating the position of the first floor of a damaged building so that the line of the floor can be shown on the outside of the wall. A measurement down from the sill to the floor by means of a lath is transferred to the outside and the position of the bottom of the lath is marked on the wall.

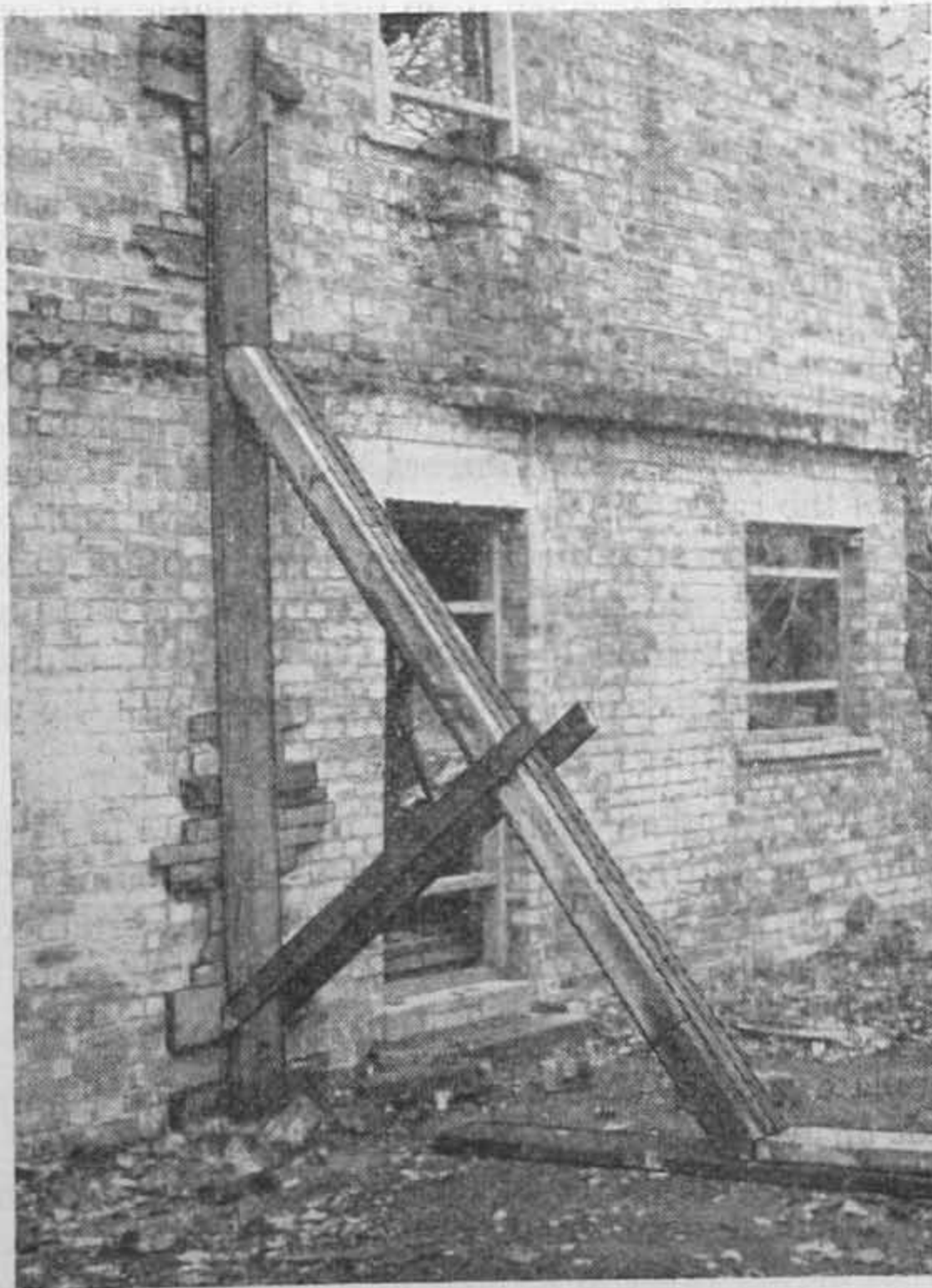

**Fig. 127. A raking shore**

### Raking shore

- 26.8 The principal parts of a raking shore are the wall plate, the raker and the sole-plate. The wall plate should be long enough to cover the area of weakness and about 9 inches by 3 inches in section.
- 26.9 The raker should be approximately square in section from say 4 in.  $\times$  4 in. to 6 in.  $\times$  6 in. depending upon the height of the shore. It can be of solid timber or can be made up of different size timbers, i.e., two 4 in.  $\times$  2 in. joists laminated together would form a 4 in.  $\times$  4 in. raker, or three 2 in.  $\times$  7 in. joists would make up a 6 in.  $\times$  7 in. raker. The centre line of the raker should aim to meet the centre line of the floor at the junction with the wall to be supported. The raker is prevented from sliding up the wall plate by a wooden cleat spiked to the plate. The necessity for speed and the possible instability of the wall will not permit the use of the "needles" found in conjunction with cleats on orthodox shoring.
- 26.10 The sole-plate rests on the ground and acts as a foundation or raft to spread the load from the raker. It must be thick enough to resist crushing by the raker and large enough to distribute the load.
- 26.11 The length required for the wall plate having been ascertained, a suitable piece of timber is selected from that available and prepared. At the correct position previously ascertained by measurement up the wall to the floor line, a wooden cleat is spiked to the wall plate. This is to take the shaped top end of the raker and to prevent it sliding up the wall plate when levered and wedged into position. This cleat should be of sound timber about 9 in.  $\times$  3 in. in size and sufficiently long to enable it to be well spiked to the wall plate.
- 26.12 Having selected and prepared the wall plate and taken the additional measurements required, the raking shore must be set out on the ground so that the correct lengths of timbers and the angles of cuts or bevels at each end of the raker can be ascertained. With the wall plate and sole-plate set out temporarily on the ground and kept in position by bricks or pieces of rubble, the raker is temporarily placed into position and the ends marked for cutting to shape. The sole-plate should be set at a slight slope so that the outside angle it makes with the raker is a little greater than a right angle.
- 26.13 With the top cleat spiked on, the wall plate can now be placed in position against the wall and held up by a temporary strut. At this point any irregularities in bearing due to bulging can be ascertained and suitable packing pieces obtained for insertion behind the plate to provide a continuous bearing.
- 26.14 The sole-plate can now be laid down and, in a similar manner, packed up to provide an even bearing to distribute the load imparted by the raker. It should be packed up to the correct inclination, the external angle being little more than a right angle with the line of the raker. This is to ensure that as the raker is levered into position it tightens, making a right angle in its final position.



- 26.15** When on hard ground the sole-plate must be built up to the required slope and secured so that it will not slip when the raker is wedged into position. One method is to drive a metal stake or piece of scrap iron spike at the back of the sole-plate. When in soft ground the earth can be excavated to the necessary slope and the sole-plate set at the proper angle.
- 26.16** The top of the raker is now placed underneath the cleat on the wall plate and the foot placed on the sole-plate. The whole structure is then gently levered into the correct position. If, in the case of a laminated raker, the centre timber is cut back slightly, this will form a notch which will provide a good bearing for the crowbar used to lever the raker into position. A small rebate in the foot of a solid raker will serve the same purpose.
- 26.17** The operation of tightening up the raker must always be done gently and never with a hammer or sledge. Such action would transmit shock to a structure already damaged with possibilities of disastrous results. While one man holds the raker tightly levered into position another nails a stout cleat onto the sole-plate behind the raker. Any irregularities in cutting may now be remedied by the use of wedges.
- 26.18** To frame and tie the shoring together, struts or braces should be fixed between the wall plate and the raker. Such braces can be placed either at right angles to the raker, or at right angles to the wall plate.
- 26.19** Packing pieces should be inserted behind the wall plate to give the plate a continuous bearing throughout its length. Such packing should always be inserted where a wall is bulged either outwards or inwards. A needle piece driven through a hole cut in the correct position in the wall plate can be inserted in an air-brick opening in the wall, and this will effectively prevent the plate riding up the wall. Any projecting oversailing or string courses on the wall should also be used for a similar purpose providing they are high enough to obviate any undue shortening of the wall plate.

### **Flying shore**

- 26.20** A flying shore is used to support one wall from another and, as its name implies, it derives no direct support from the ground. It can also be used between two buildings which are sound structurally but have been deprived of normal support by the removal of a building formerly between them. In rescue work the flying shore will normally be used so that a damaged building can be supported by an adjacent structurally sound building by bridging the gap between them with timbers, so framed and erected as to transfer the loads from the one to the other.
- 26.21** The principal parts of a flying shore are the horizontal beam, wall plates and struts or bracing pieces. Other parts used are straining pieces, wedges and cleats, all of which assist in securing the shoring in position and transferring the load.
- 26.22** It is first essential to ascertain the distance between the two buildings in order that suitable shoring timbers can be selected from the debris available. This can be done without the use of measuring rods or tapes

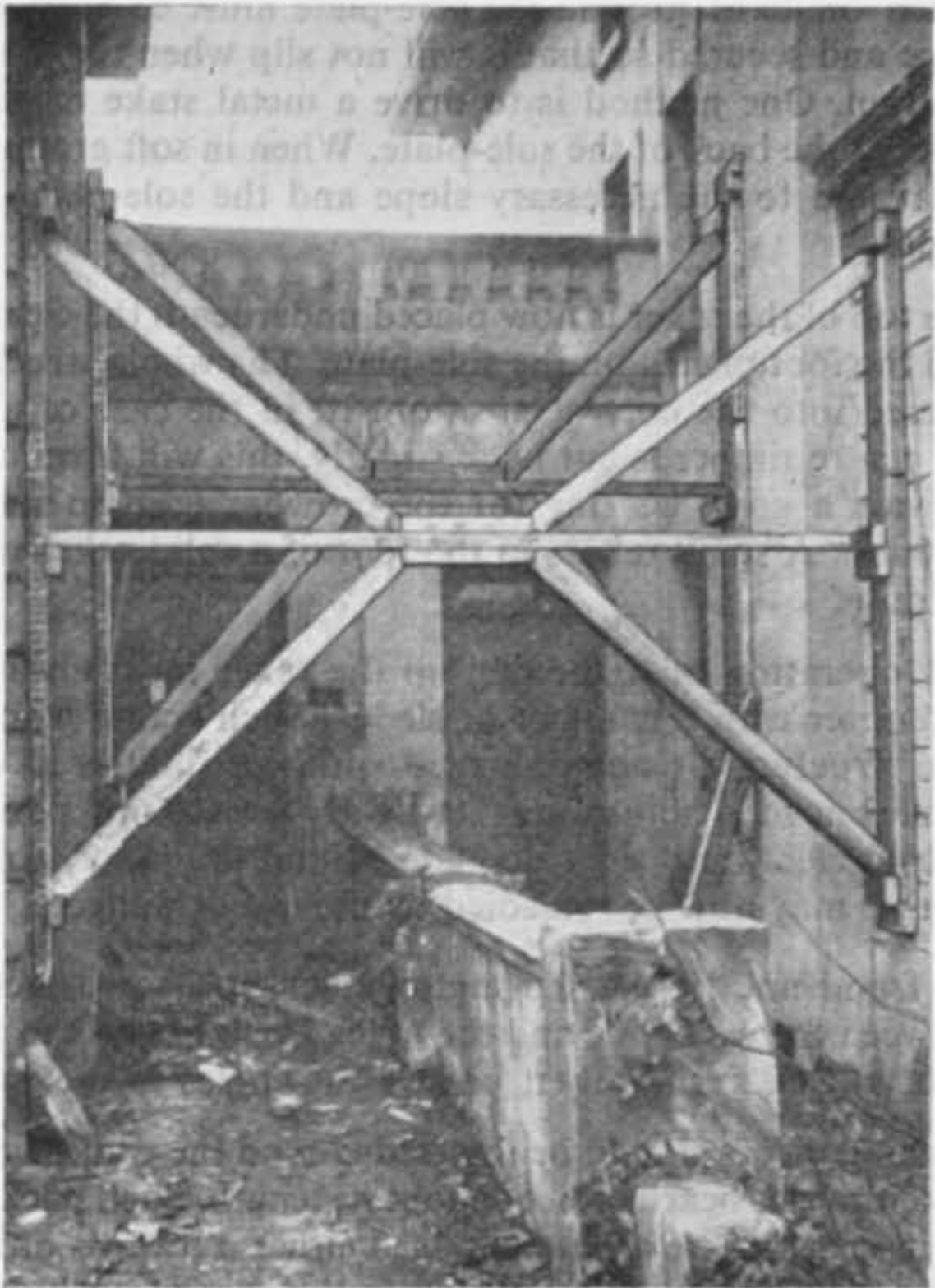

Fig. 128. Flying shore

by utilising two pieces of wood as distance pieces. The two pieces of wood are held together at the height at which the horizontal beam is to be placed and adjusted until their combined length registers the width between the walls. The measurement thus obtained is then transferred to the beam being assembled on the ground, due allowances being made for the thicknesses of wall plates and wedges.

**26.23** In a similar manner, pieces of lath can be used to measure the requisite length for the wall plate, remembering that this length should be sufficient to ensure that the weakened area of the wall is covered. If stout and straight enough, these measuring pieces will also indicate the amount of bulge in the wall, and consequently the thickness of packing required behind the wall plate to ensure that it has a uniform bearing on the wall.

**26.24** Suitable timber should now be selected for the horizontal beams. As in the case of the rakers this can be made up of smaller section timbers such as joists, provided that they are well laminated and securely spiked together. The size of the finished beam will depend upon the width it is required to span, and would vary from 6 in.  $\times$  4 in. to about 6 in.  $\times$  6 in. for spans of 10 ft. to 20 ft. respectively. The laminated horizontal beam is made up, spiked together and cut to the length ascertained by

the measuring rods, after due allowance has been made for wedging and for the thicknesses of the wall plates selected. Sound timbers should be chosen and of matching sizes.

- 26.25** At this stage the straining pieces should not be nailed to the horizontal beam, but temporarily secured to it, one above and the other below, by means of two wire bonds. This keeps the straining pieces in position during erection, and enables them to move as required during the wedging up process.
- 26.26** Measuring rods should be used to mark the length of the wall plates. The width of the plate should not be less than the width of the beam, and its thickness should be sufficient to resist crushing by the beam when this is wedged into position. The wall plates should then be propped up at the correct distance apart on a cleared flat piece of ground, and the points where the beam and braces will be positioned marked with chalk, so that the cleats can be spiked in the appropriate

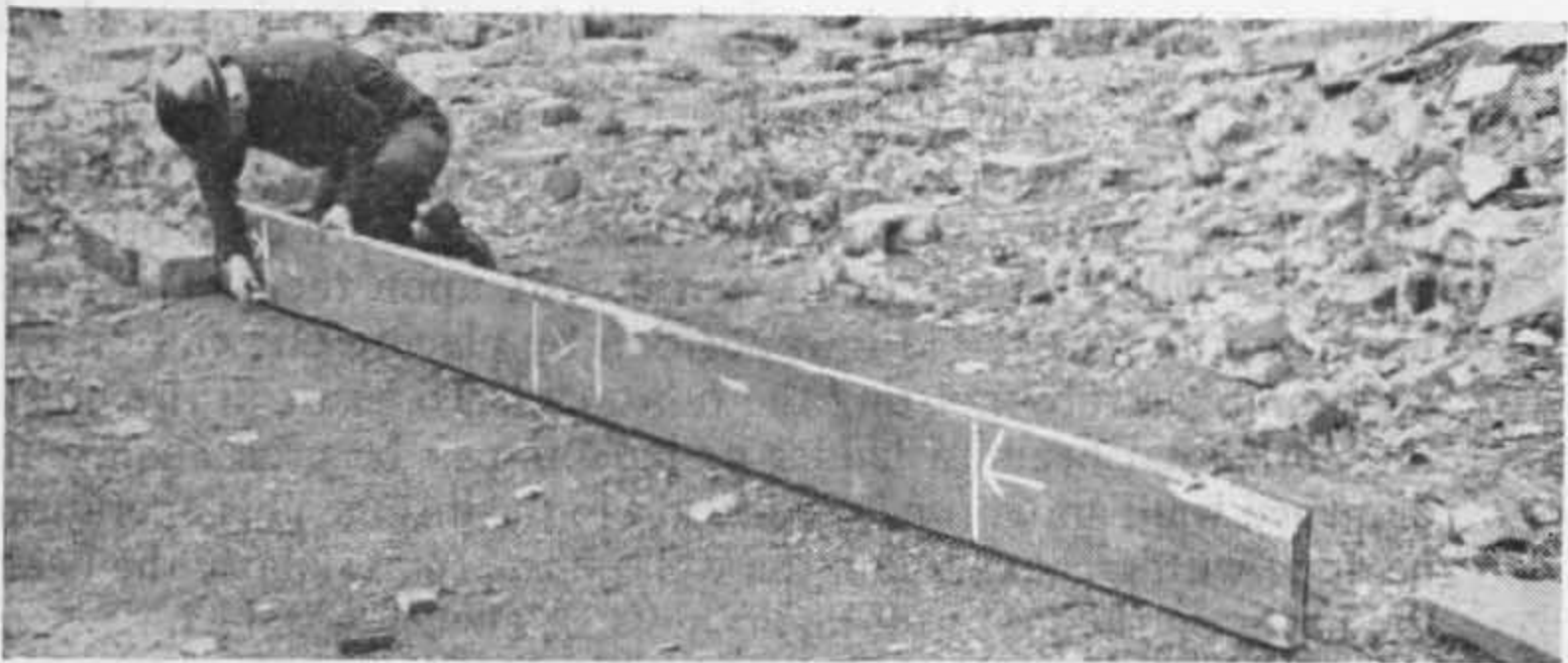

**Fig. 129.** Marking the positions

places. As with the raking shores, the cleats should be of sound timber and of sufficient length to provide adequate fixing. Normally it is better to fix them with their grain and maximum dimension lengthways down the wall plates rather than across.

- 26.27** At this stage, any known requirements for packing pieces can be added, and if the packing is spiked to the back of the wall plate prepared for the damaged wall it will be possible to place the wall plate in its correct position more easily.
- 26.28** With the cleats spiked in position and the horizontal beam in place, templates can be marked indicating the cuts to be made at the ends of the braces and their correct lengths. The bracing pieces can now be made up, using timbers to form braces of about 4 in.  $\times$  4 in. section, e.g., two 4 in.  $\times$  2 in. joists of sufficient length. The cleats should have been fixed so that the braces will butt against them and against the straining pieces on the horizontal beam, and slope at an angle of 45 degrees between the beam and the wall plates. The angles cut at each end should also be at 45 degrees, and the ends should be cut squarely to make a good bearing.

- 26.29** The complete flying shore can now be assembled on the ground, and all points checked to ensure good fitting joints, or ample clearances where folding wedges are required for framing up purposes. When assembled thus, the dimensions should be carefully checked by means of the measuring rods to make certain that the whole structure will properly fit between the walls and can be wedged up securely so as to perform its function. Before moving any pieces on to the job, the parts should be clearly marked so that they can be re-assembled in their correct positions.
- 26.30** The erection of the flying shore can now be commenced, and this is started by placing the appropriate wall plate against the damaged wall, temporarily strutting or propping it in position, and inserting any temporary packing pieces needed. In many cases the damaged wall may be unsafe and should not be used to support ladders until at least some support has been given to it by the shoring. A strut can be fixed to provide temporary support to the wall plate. This strut is lodged under the middle cleat which will carry the horizontal beam. Care should be taken not to subject the damaged wall to undue jarring or shock.
- 26.31** The wall plate on the damaged wall having been positioned, the other plate can be temporarily fixed in a similar manner, taking care to ensure that the tops of the two middle cleats are level with each other, so that the beam will be horizontal when it rests upon them. The horizontal beam can now be raised into position by placing one end on one wall plate and carefully hoisting the other end. To assist in the hoisting of the horizontal beam, a ladder or ladders can be used against the undamaged wall, and a rope used to aid in the lifting. This operation must be done with great care and the wall plates, (particularly the bearing of the beam on the first wall plate) must be closely watched.
- 26.32** Folding wedges are driven in at the end of the horizontal beam by the sound wall to tighten the beam securely against the wall plate on the damaged wall, so that any load exerted by the tendency of the wall further to move or bulge will be transferred by the beam to the strong supporting wall and thereby resisted.
- 26.33** Having received some support, the damaged wall can be expected to withstand the weight of a short ladder, and the flying shore may be completed by the insertion of the four diagonal braces. The lower pair should be fixed first and be a tight fit between the straining piece and the bottom cleats, but it must be wedged if necessary. The upper pair of braces should be fixed and wedged tightly into position with folding wedges at each end of the straining piece. The shore is now firm enough to support ladders and erectors.
- 26.34** The flying shore is completed by tightening up the folding wedges and inserting any necessary packing pieces to ensure that the wall plate at the bulging wall has an even and continuous bearing throughout its length. The straining pieces should now be spiked to the horizontal beam and the wire bonds removed.
- 26.35** It is not advisable to erect a flying shore between two walls which are more than 25 feet apart. Additional flying shores should be placed along

the wall requiring support, at intervals of 8 ft. to 12 ft. depending upon the circumstances and degree of damage.

### Dead shores

- 26.36** A dead shore carries the vertical load of a wall or floor. The dead shores act as stanchions and should be as short and as stout as possible. They must always be placed on a firm support and, where different levels are encountered, shores must be carried down until they can obtain adequate support.
- 26.37** The principal parts of a dead shore are the sole-plate, the dead shores and the headplate. Other items are braces—to tie two or three shores together, and folding wedges.
- 26.38** It must be remembered that although raking and flying shores mainly oppose the sideways or overturning tendency, dead shores take the full weight of the structures above. It is very important therefore that they have a solid bearing for the sole-piece.

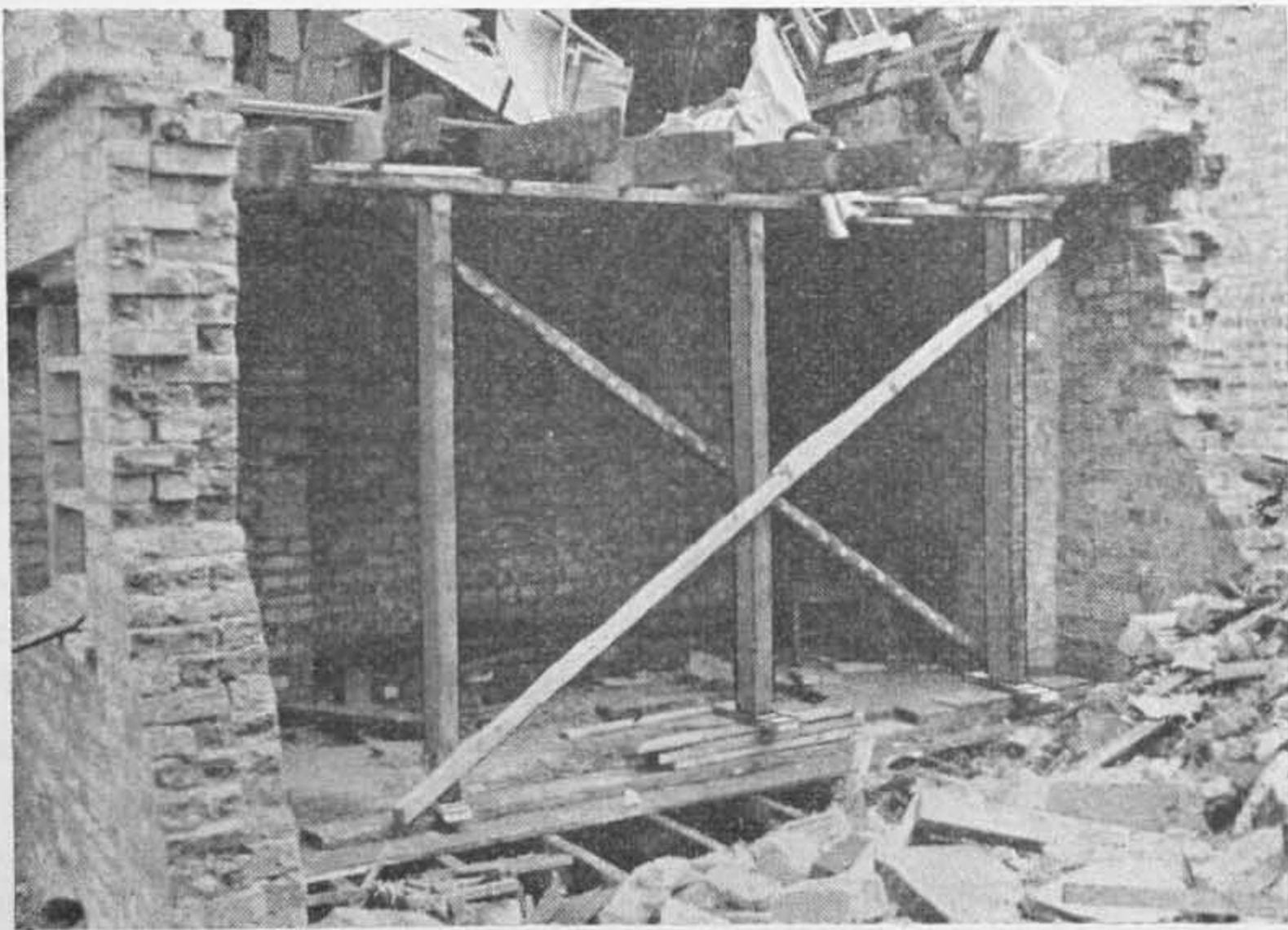

Fig. 130. Improvised dead shore

- 26.39** Improvised dead shoring can be utilised to support the weight of floors which have lost their normal bearing or if such bearing has been weakened. The principles used in heavier types of dead shoring must still be applied; the sole-piece must be as broad and as long as possible in order to spread the load, the headpiece must be stout enough to carry the load between the supporting dead shores and be in as long a length as possible, and the shores must be strong enough and spaced close enough to carry the load, remembering that the strength of the dead shore will be increased if the ends are cut squarely to fit on the head and sole-piece.

- 26.40** In erection, the sole-piece is laid down in position, taking care that it is on a solid foundation. The headpiece is held in position and the vertical or dead shores are then placed upright between the head and sole-pieces and securely wedged by pairs of folding wedges and any necessary packing inserted between the dead shores and the sole-piece. These wedges must be tightened simultaneously. The headpiece should be kept as level as possible, and packings may be required on top of the headpiece to take the load. If, because of difference in height, the amount of such packing becomes abnormal, two headpieces at different levels should be used, but they must be adequately cross-braced.
- 26.41** In using folding wedges, care should be taken that the wedges are correctly tapered and "married", i.e., one point overlaps the other, before tightening is attempted. Cross-bracing should be added where possible, and these braces should be long enough to extend diagonally across the dead shores from head to sole-piece, and nailed to each shore in turn.

## CHAPTER 27

### Steel Wire Ropes

**27.1** Wire rope is a hard-wearing item of equipment, but unless properly handled cannot give of its best. To work efficiently and give long service, it needs thorough care and maintenance and proper use on whatever job may be in hand. Stated in the simplest language, a wire rope is a combination of wires twisted to form a strand; those strands are then twisted ("laid") round a centre core of specially prepared and treated fibre to form a rope. In manufacture, steel wire ropes are fully lubricated (including the fibre core) to reduce friction between the wires, to exclude moisture and prevent corrosion. In use the initial lubrication is gradually exuded and should, as far as possible, be replaced by periodical application of an approved wire rope "dressing". The most suitable type of dressing is that supplied by the manufacturers of wire ropes.

#### Unwinding from a coil

**27.2** Wire rope cannot be drawn off from a coil, as if this is attempted kinks will form in the rope. A light coil of wire rope of the kind supplied for use in rescue can be unrolled along the ground but should always be kept under control.

#### Lubrication of wire rope

**27.3** As stated in paragraph 27.1, the rope is suitably impregnated with lubricant during manufacture, but when it has been used under rescue conditions dirt and grit are picked up by the rope and after use they must be removed with a wire brush, after which the rope should again be given a light coating of "dressing". This will not merely keep the rope in good workable condition, but will prevent rusting of the metal.

#### Safe working load

**27.4** It is most unlikely that wire rope in use in rescue work will be subjected to undue strain as most of the loads to be handled are well within the capabilities of the ropes supplied. Steel wire rope is about nine times as strong as fibre rope of the same thickness. It has already been stated in the chapter dealing with fibre ropes that a 2 in. fibre rope has a safe-working load of 4 cwts., and as the  $\frac{5}{8}$  in. diameter steel wire ropes have a similar circumference, it can be seen that in this case the S.W.L. would be 36 cwts.

#### Care in use

**27.5** Wire ropes should never be bent sharply at any point. As a general rule, the smallest diameter round which a wire rope is to be bent should be approximately 6 times the circumference of the rope; anything smaller than this will set up undue strain on the steel wires. With a  $\frac{5}{8}$  in. diameter (i.e. 2 in. circumference) wire rope, the minimum diameter about which

it can be bent without causing harm to the rope is 12 inches. Care must be taken, therefore, by packing or otherwise, to ensure that the rope is not damaged when it has to be bent round any object.

#### **Inspection of wire ropes**

##### **27.6 Starting at one end of the rope:**

- (a) Check the shackle used with the rope to see that it has not suffered distortion or strain, and that the shackle pin is in good condition and can be easily screwed home by hand.
- (b) Examine the thimble and splice. The splicing cannot be seen as it is covered by the wire binding or "serving", but if the serving is loose or shows signs of bulging it is probable that this splice is starting to become undone.
- (c) Working along the rope a hand's breadth at a time, see that it is reasonably round, i.e. has not been flattened in use or suffered distortion which causes the wires to open and thus weaken the rope.
- (d) Look for broken wires. A broken wire in a rope should always receive prompt attention. Delay may lead to serious accidents, and will certainly cause damage to other wires. The method often used to deal with a broken wire by nipping it off with pliers is by no means the best way, for this leaves a little jagged end. To save time and trouble, simply bend the wire backwards and forwards with the fingers until it breaks, or, in the case of a short end, use a piece of wood. In this way the wire breaks inside instead of outside the rope, and the end is left tucked away between the strands, where it can do no harm to the other wires or personnel.
- (e) Look for kinks. When a rope has been kinked the kink may, in use, pull out, and the rope may appear to be reasonably straight while the structure of the rope may easily have been distorted. The length affected by kinking may be only a few inches, and yet cause this part of the rope to be weak. The presence of a kink is best detected when the rope is lying slack on the ground.

Ropes found defective should be labelled and placed apart from ropes in good condition until they can be examined by a competent person.

#### **Storage of wire ropes**

- 27.7** Wire ropes should be stored under cover in a clean, dry place and in such a manner that no part of the rope rests on the ground. They must never be stored by laying on concrete, ash, clinker, or coke breeze floors as these materials have a bad effect on the steel. Periodical examination of all wire ropes in store is necessary to ensure that the ropes are not becoming corroded.

#### **Records**

- 27.8** The result of all inspections, including details of any damage found, should be recorded by a responsible officer in the Register of Chains, Ropes and Lifting Tackle.



## CHAPTER 28

### Slings

28.1 For slinging heavy loads to be lifted by apparatus set up by rescue parties, chains and wire slings are carried on company equipment vehicles.

#### Chain slings

28.2 The chain slings supplied are of the single leg type with a hook at one end and a ring at the other, and are rated at a safe working load of 15 cwts.

#### *To lift a load with a chain sling*

- 28.3 (a) The ring of the sling can be placed on the hook of the lifting tackle and the sling hook placed in the ring, or
- (b) the ring of the sling can be placed on the hook of the lifting tackle and the sling hook placed around the chain after passing the chain around the article to be slung. When the latter method is used, the bight should be forced down as low as possible to ensure a firm grip on the load.

#### *Shortening a chain sling*

28.4 Chain slings should never be shortened by tying a knot in the chain as this will cause excessive bending stresses in some of the links and may result in damage or fracture. If it is necessary to shorten a chain sling the method shown in Fig. 131 should be adopted.

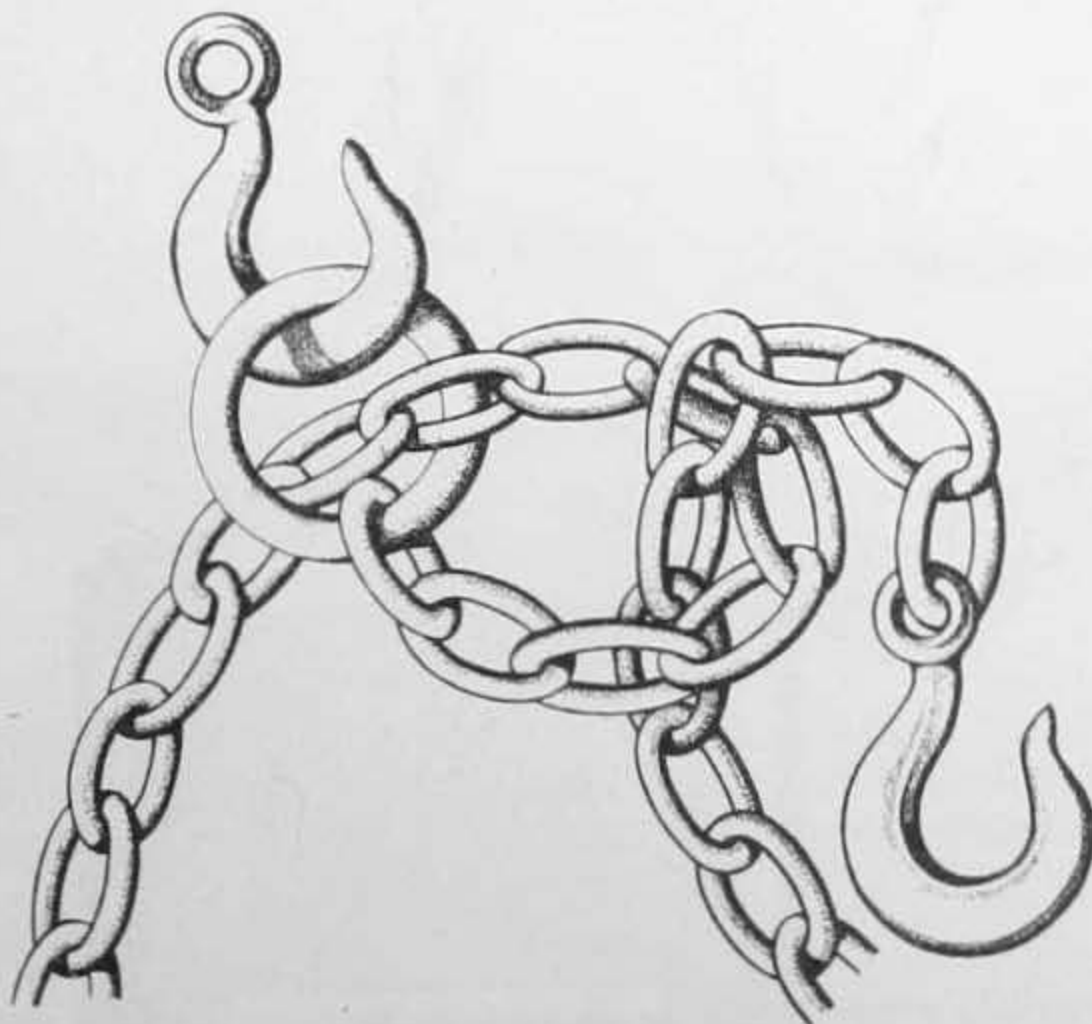

Fig. 131. The links of the upward and downward passing parts of the chain interlock in the ring

### Wire rope slings

28.5 Wire rope slings supplied with rescue equipment are of the single leg type capable of dealing with loads up to 15 cwts. They are lighter in weight than chain slings of equal S.W.L. but are more susceptible to accidental damage and require greater care in use.

### General precautions in use of slings

28.6 The method of slinging any given object must vary according to circumstances, but certain general rules and precautions should be observed to ensure safe working.

- (i) The size, and therefore the strength of the sling selected, will be governed by the weight of the load. (For estimating loads likely to be met with see Appendix K).
- (ii) The efficient use of a sling is governed by the angle between the legs of the sling or the position in which it is used.
- (iii) Timber packing must be inserted between the sling and the edges of the load to prevent the sling coming in contact with sharp edges.
- (iv) Hooks must be moused.
- (v) Wire rope slings must not be bent round too sharp an angle and, to prevent this, timber packing must be used to ensure an even curve.
- (vi) The shackle of a wire rope sling must not be placed around the sling to provide a bight.
- (vii) Carelessness in hoisting, e.g. shock lifting or snatching, must be avoided.
- (viii) Slings should not be dragged along a floor or the ground, and should never be pulled from under a load which, when lowered, is resting on the sling.

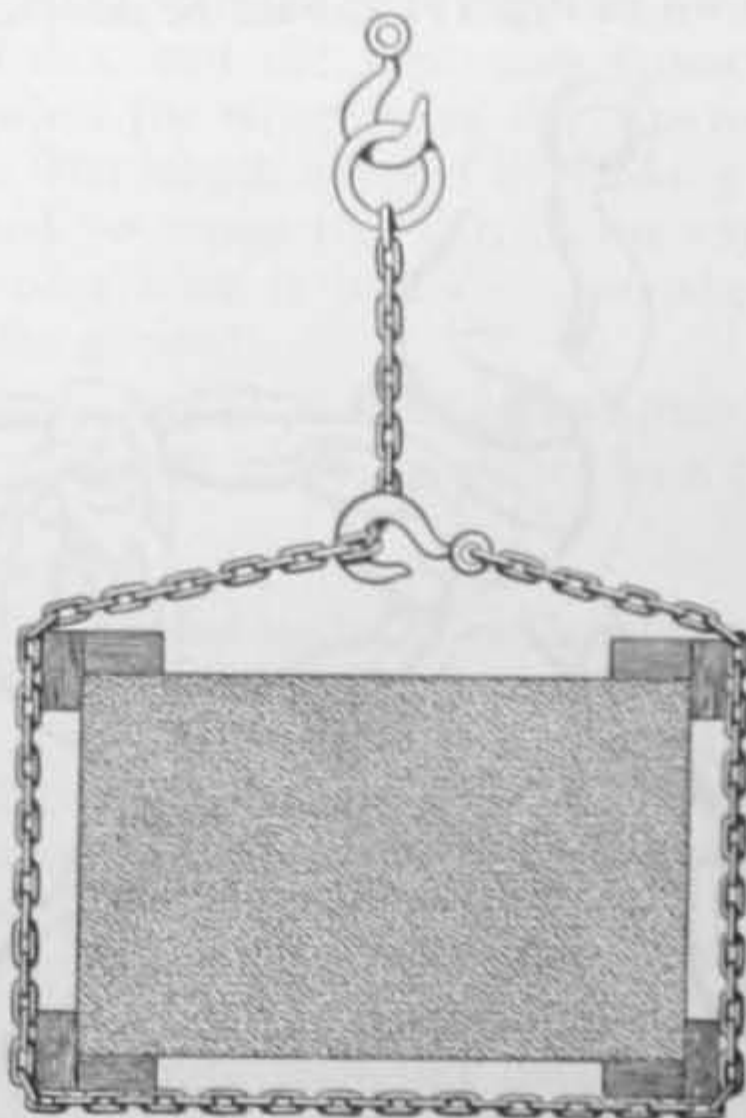

Fig. 132. Single chain sling reeved round a load, with bight forced down close to load

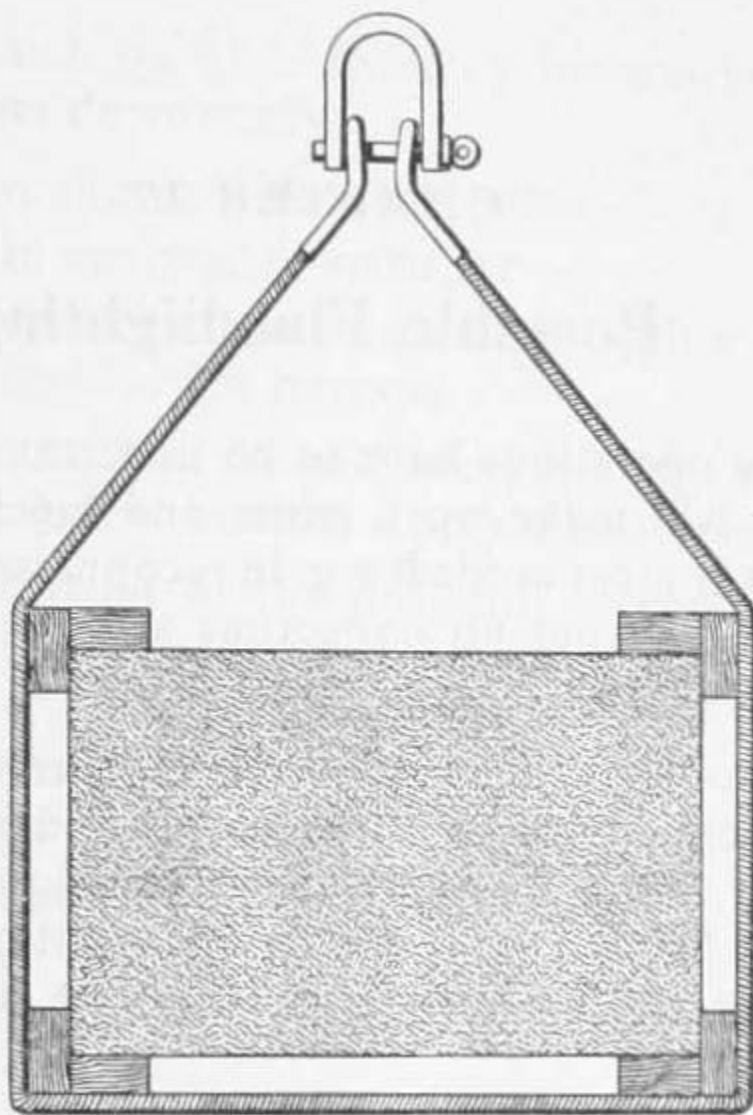

Fig. 133. Wire rope sling with ordinary thimbles at both ends secured by shackle and pin after being reeved round a load

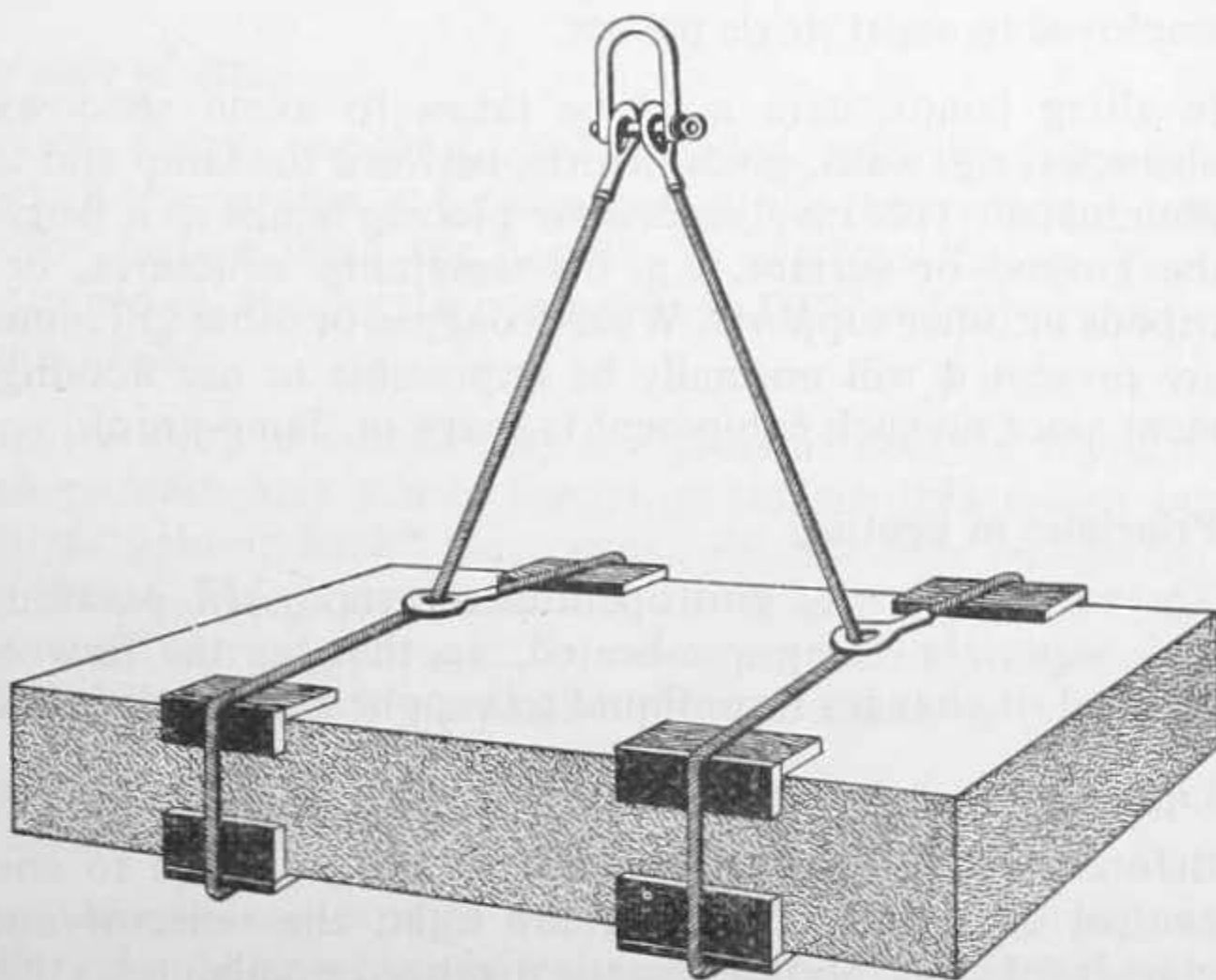

Fig. 134. Two slings in use (chain or reeved wire sling). Horizontal distance between points of attachment to load should not exceed the free length of sling leg. Angle at junction of sling legs should be approximately 60 deg.

### Methods of slinging

28.7 In the event of being unable to obtain the necessary chain or wire rope sling, the rescue man should be able to improvise by using the 40 ft. lashing line.

## CHAPTER 29

### Portable Floodlighting

- 29.1 Where rescue operations have to be undertaken after dark, the use of floodlighting will make work easier and quicker by giving additional light where it is most needed, e.g. in reconnaissance, in certain methods of rescue, in showing up dangerous structures or in unloading and carrying of equipment, or traversing debris.
- 29.2 The type of floodlighting employed must therefore be portable, capable of being quickly brought into action, and robust enough to stand handling over debris. The type of portable floodlight projector supplied to the Rescue Section as standard equipment meets these requirements. The projectors will be carried on the rescue equipment vehicle of each rescue company.
- 29.3 The permitted use of floodlighting during enemy activity will be at the discretion of the Controller. The direction and siting of the floodlighting units will normally be under the control of the company or platoon rescue officer, although the equipment may, if necessary, be employed to assist single parties.
- 29.4 In siting lamps, care must be taken to avoid shadows thrown by obstacles, e.g. walls, posts, debris, between the lamp and the area to be illuminated. This may necessitate placing lamps at a height well above the ground or surface, e.g. on remaining structures, or perhaps on tripods or other supports. Where coal gas or other inflammable vapours are present it will normally be impossible to use floodlighting equipment since no such equipment is spark or flame-proof.

#### Principles of lighting

- 29.5 The paraffin type of unit operates on vaporized paraffin, the burner and vaporizer being pre-heated, so that, as the flow of paraffin is released, it changes from liquid to vapour and burns inside the mantle.

#### Lighting

- 29.6 Before actually lighting, a check should be made to ensure that the control cock and vapourizer are tight, the reflector and toughened glass front clear, and the mantle arranged evenly.
- 29.7 To light the projector:
- (a) Check that control knob is off.
  - (b) Remove pump, insert funnel and pour about 6 pints of paraffin into container (2/3rds full). The oil level indicator will then read "FULL".
  - (c) Replace pump and tighten securely by hand. Do NOT pump at this stage.

- (d) Release catch on glass front by unscrewing sleeve until the catch hinges downwards.
- (e) Take torch clip provided and either
  - (i) soak in methylated spirit, or
  - (ii) remove wicks from clip and fill with a special compound produced for the purpose.
- (f) Open glass front of the projector, and clip torch to vaporizer about 2 in. below mantle. Apply a match to the torch.
- (g) Keep glass front of the projector closed while the torch is burning, but when the flame begins to burn low (after about 2 mins.) turn the knob on the control cock (which may be reached through aperture at the back of the casing) to "ON".
- (h) Pump *gently* until lamp lights with a "pop". When the projector is alight, continue pumping until the centre of the indicator on the container is level with the outer rim. *Do not over-pump.*

### Extinguishing

29.8 To extinguish the lamp, simply turn the control knob to "OFF". It is not necessary to release pressure at this stage, but pressure should be released before re-lighting.

### Hints on care of lamp

- 29.9 When filling, always use the funnel provided, with the gauze insert to strain dirt. Keep paraffin in a clean can. While the lamp is in use, it is possible for carbon from the paraffin to get into the jet. The jet is quickly cleaned by turning the control knob OFF and ON quickly while the lamp is alight.
- 29.10 Do not let the lamp burn on a very low pressure because, if you do, the vaporized paraffin may not be forced up sufficiently strongly into the burner, and "lighting back" may occur, which will be recognized by a "roaring" noise. This is detrimental to the mixing tube, and if allowed to continue will burn it through. To overcome roaring, turn the control knob OFF and ON quickly and give more pressure by pumping.
- 29.11 Do not use broken mantles or the naked flame may discolour the reflector and break the toughened glass.
- 29.12 The joints are only required to be hand-tight; there is no need to use pliers. Joints should be inspected from time to time and tightened where necessary. Washers should also be inspected and cleaned.

## CHAPTER 30

# Flame Cutting

### General

- 30.1** When iron or steel obstructions are encountered in the course of rescue work, the most rapid means of cutting a way through is with the oxy-acetylene blowpipe. It should, however, be borne in mind that only readily oxidisable steels can be cut by this process, consequently stainless steel not being oxidisable cannot be cut with ordinary cutting equipment. Cast iron can only be cut by a special technique of weaving the blowpipe very slowly with a semi-circular motion. Brass, bronze and copper, which do not oxidise rapidly, cannot be cut. Bars and thin sections of these metals can, however, be melted away by the high temperature of the flame, and this may on occasion prove useful.
- 30.2** Briefly, the equipment for this method of cutting consists of a cutting blowpipe, a cylinder of oxygen, a cylinder of acetylene, and oxygen and fuel gas regulators, devices which are screwed into the cylinder valves for reducing the pressures of the gases to those required at the blowpipe. To these regulators are connected lengths of hose for conveying the gases to the cutting blowpipe, to which their other ends are connected. The cutting blowpipe is the tool with which the severing of the steel is done.

### Principle of the flame cutting process

- 30.3** The cutting blowpipe is so constructed that part of the oxygen entering it is mixed with acetylene within the blowpipe; the mixed gases issue from a ring of slots in the nozzle and when lit produce the very high temperature flame for heating the steel to be cut. The remainder of the oxygen, separately controlled by a lever-operated valve, issues as a jet of oxygen only, from a hole in the centre of the ring of heating flame jets.
- 30.4** The action of flame cutting, or more accurately, oxygen cutting, relies on the fact that steel, when heated to incandescence (bright red heat) will oxidise or burn rapidly in an atmosphere of pure oxygen. The cutting blowpipe makes use of this phenomenon by employing the very hot oxy-acetylene flame to heat a spot on the steel to incandescence and then making it possible to direct a jet of pure oxygen on to the heated spot and burn the steel away in a shower of sparks. The extreme tips of the pre-heat flames are the hottest part. So rapid is this burning action that it is possible to pierce a small hole through a piece of steel several inches thick in two or three seconds from the time that the oxygen jet first impinges on an incandescent spot on the surface of the steel. In practice it is always advisable to start on the edge of the piece to be cut. It takes only a matter of a few seconds preliminary heating with the flame to bring a spot on the edge of the piece of steel to incandescence; the jet of "cutting" oxygen will then burn the steel, which produces additional

heat. The heat of the flame plus the heat of the burning metal makes it possible to advance the blowpipe at speeds of from 6 in. to 2 ft. per minute, always maintaining a hot spot in advance of the cutting oxygen jet so that a continuous narrow cut is made. This cut is only slightly wider than the diameter of the hole in the nozzle from which the cutting oxygen issues.

30.5 The purpose of having a ring of jets for the heating flame is twofold; it allows the cut to proceed in any desired direction, as by this arrangement there is always a part of the heating flame in front of the cutting jet, while a considerable part of the remainder of the flame passes down the cut as it proceeds and maintains the necessary heat throughout the full depth of the cut.

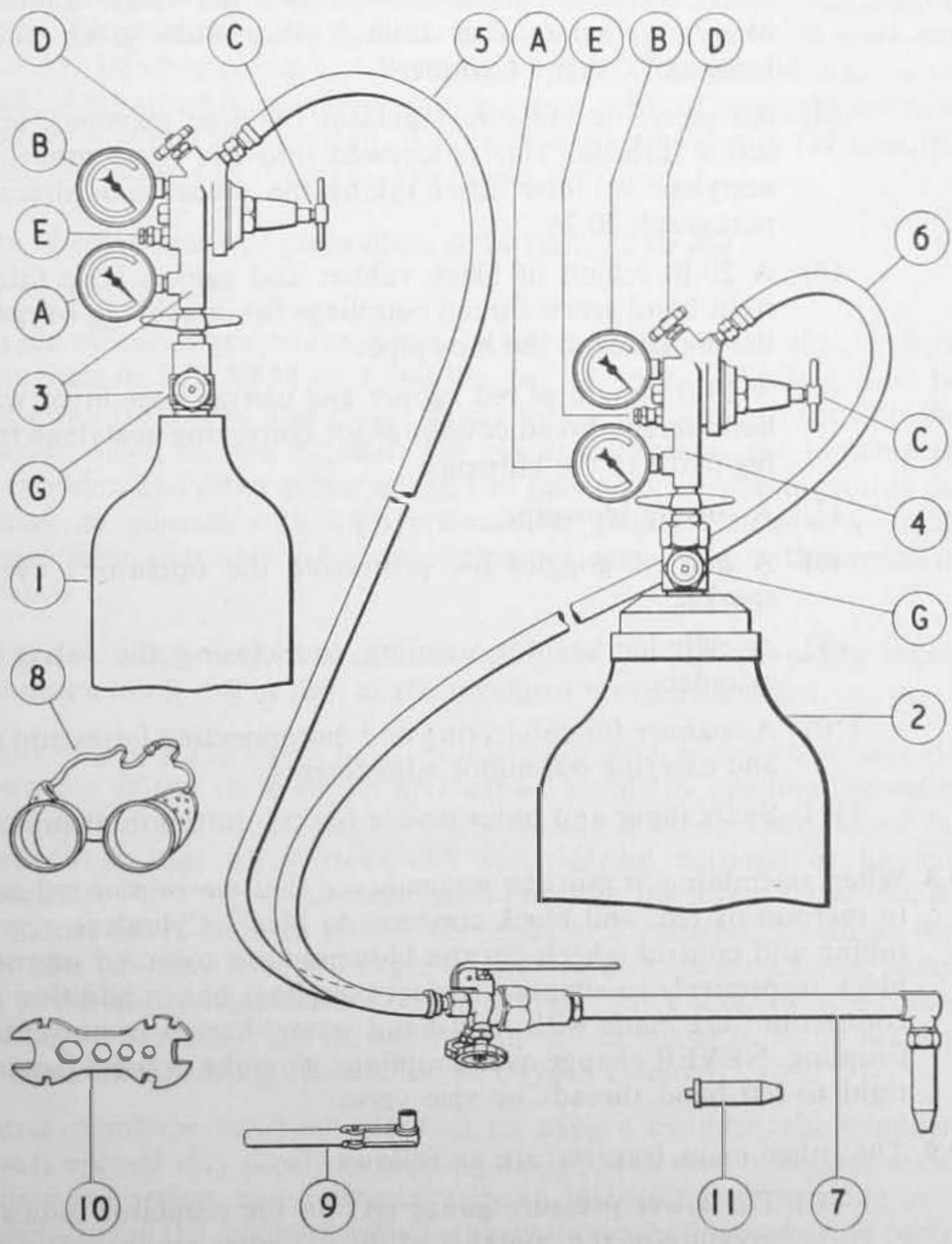

Fig. 135. Cutting equipment

30.6 As flame cutting relies on rapid transfer of heat down the depth of the cut, it is more difficult to cut two or more plates riveted together than it is to cut a much greater thickness of solid metal, because the heat is not transferred so readily from plate to plate, particularly if there is any rust in the joint.

#### **The components and their assembly**

30.7 The components required for cutting are assembled as shown in Fig. 135. They are as follows:

- (1) An oxygen cylinder (painted black).
- (2) An Acetylene cylinder (painted maroon).
- (3) An oxygen pressure regulator (painted black), right-hand screw threads. This is screwed into the valve mouth of the oxygen cylinder, after taking precautions given under the heading "Oxygen Cylinder".
- (4) An acetylene pressure regulator (painted maroon), left-hand screw threads. This is screwed into the valve mouth of the acetylene cylinder, after taking the precautions described in paragraph 30.26.
- (5) A 20-ft. length of black rubber and canvas hose fitted with right hand screw thread couplings for conveying oxygen from the regulator to the blowpipe.
- (6) A 20-ft. length of red rubber and canvas hose fitted with left-hand screw thread couplings for conveying acetylene from the regulator to the blowpipe.
- (7) A cutting blowpipe.
- (8) A pair of goggles for protecting the operator's eyes from sparks.
- (9) A cylinder key for opening and closing the valves of the cylinders.
- (10) A spanner for connecting and disconnecting hoses and nozzles and carrying out minor adjustments.
- (11) Spare inner and outer nozzle for the cutting blowpipe.

30.8 When assembling, it must be remembered that maroon or red connects to maroon or red, and black connects to black. Cylinders, regulators, tubing and control wheels on the blowpipe are coloured maroon and black respectively to simplify correct coupling, but in addition oxygen connections are made with right-hand screw threads to prevent wrong coupling. NEVER change over couplings, or make or use adapters from right to left-hand threads or vice versa.

30.9 The other main features are as follows:

- (i) The lower pressure gauge (A) on the regulator indicates the pressure of the contents of the cylinder, graduated in pounds per square inch.



- (ii) The upper pressure gauge (B) indicates the delivery pressure to the blowpipe, graduated in pounds per square inch.
- (iii) The delivery pressure to the blowpipe is controlled by the pressure adjusting screw (C). Screwing in increases the pressure, screwing out reduces the pressure.
- (iv) A stop valve (D) is provided at the outlet and should be fully opened (about two full turns) when operating.
- (v) A safety valve (E) is provided to permit the gas to escape to open air in the event of any defect permitting excessive pressure to reach the delivery side of the regulating valve. Its purpose is to prevent bursting of hoses. The cylinders are provided with a stop valve (G) operated by the cylinder valve key.

**30.10** It is advisable to have at hand screwed couplers and additional lengths of hose for increasing the distance from the cylinder at which work can be done. Jointing pieces and worm drive hose clips should also be on hand for repairing hoses should they get torn or burnt under the arduous conditions which may prevail. It is inadvisable to use wire for securing hoses to couplers as it cuts and damages the hose.

#### **Care of equipment and precautions to be taken in its use**

##### *The oxygen cylinder*

- 30.11** Oxygen cylinders are painted black. A full oxygen cylinder should show a pressure of 132 ATM or 1,980 lbs. per sq. inch. Cylinders must be kept away from heat and places where oil or grease might get into the cylinder valve, as heat expands the gas and increases the pressure in the cylinder, and oil or grease of any sort may oxidise instantaneously on coming in contact with high pressure oxygen, and so produce such intense heat that the valve or equipment may burn with explosive violence.
- 30.12** Oxygen cylinders may be used in any position but care should be taken that they cannot roll or fall, as the regulator may be damaged.
- 30.13** Before fitting a regulator to a cylinder, dirt and grit must always be blown out of the valve socket and screw threads by opening the valve quickly about a quarter of a turn and closing it again. Care should be taken to do this away from any smouldering material or lighted cigarette as the oxygen will cause such things to burst into flame. Soap-suds must never be used to test for leaks at a cylinder mouth as the fatty film left may have the effect of causing an explosion in the same way as oil mentioned above. Oxygen cylinder valve sockets have right-hand screw threads, thus no attempt should be made to fit or adapt a left-hand threaded regulator to fit an oxygen cylinder.
- 30.14** After a regulator has been fitted to an oxygen cylinder, the cylinder valve is opened very slowly by tapping the key, as a rush of oxygen may, by its wave action, cause momentarily an intensely high pressure and temperature in the regulator which may ignite the seating and cause parts to burn with explosive violence.

- 30.15 Oxygen must not be used to ventilate any tank or enclosed space for it may cause the operators clothing to burst into flame from a stray spark.
- 30.16 A cylinder valve should always be closed before removing the regulator. Cylinders must be handled carefully whether they are full or empty, and not allowed to come in contact with electric cables, or placed where the blowpipe flame can impinge on them, or where slag, or sparks from cutting, can come in contact with them.

#### *Acetylene cylinders*

- 30.17 Acetylene cylinders must be stored and used standing upright as the gas is compressed to a liquid which will otherwise be discharged to the detriment of cylinder and equipment. A full acetylene cylinder will show approximately 225 lb. per square inch pressure, but this may vary with temperature. The only accurate way to ascertain the contents is by weight. Acetylene weighs 1.1 oz. per cubic foot. The tare or empty weight is shown on each cylinder, the difference between this and the weight shown by the scale if converted to ounces and divided by 1.1 will give the contents in cubic feet.
- 30.18 Cylinders of dissolved acetylene become dangerous when heated up:
- (a) as the result of being involved in a fire;
  - (b) by the decomposition of the acetylene and solvent contained in the cylinder;
  - (c) as the result of backfire;
  - (d) through careless handling of the cylinder when in use.
- 30.19 Once decomposition within the cylinder has begun, the action likely to prove most effective is to cool down the cylinder by the application of a copious supply of water applied in the form of a spray, leaving the cylinder in position. The release of gas by opening the main valve in an attempt to relieve internal pressure will not ease the position. In fact, the passage of fresh gas through the hot spot will tend to accelerate the rate of decomposition and thus increase the risk of explosion. Where a cylinder of dissolved acetylene which has become hot is found with the main valve closed, the valve should be kept closed. Where a cylinder of dissolved acetylene which has become hot is found with the main valve open, the valve should (if practicable) be closed.
- 30.20 The majority of dissolved acetylene cylinders are fitted with pressure relief devices of the following types:
- (a) a pressure relief disc in the body of the main valve;
  - (b) a pressure relief disc in the body of the main valve and also a pressure relief disc in the base of the cylinder;
  - (c) a fusible plug in the shoulder of the cylinders.
- 30.21 In the event of the pressure relief device operating and allowing the gas to escape, there is no way of controlling this escape of gas by means of the main valve. In these circumstances, therefore, the position of the valve is immaterial and if it is open no attempt need be made to close it.

- 30.22** When the cylinder is being cooled in position, after a reasonable lapse of time (not less than one hour) an exploratory examination should be made to ascertain that the cylinder is cooling, and further examinations should be made periodically until the officer-in-charge is satisfied that the cylinder has completely cooled. The cylinder should then be removed and immersed in a tank of water where it should be left for 12 hours.
- 30.23** In rescue operations e.g. where the cylinder is in a building containing casualties, the officer-in-charge may decide to have the cylinder removed after decomposition has started. The cylinder should be removed to a place where any explosion or fire will be least likely to cause casualties or damage, and it should be immersed in water for at least 12 hours.
- 30.24** Once decomposition has begun within the cylinder, it must be treated as an explosive missile and steps taken, in conjunction with the police, to warn the population in the vicinity.
- 30.25** Acetylene cylinder valve sockets have a left-hand screw thread, thus no attempt should be made to fit a right-hand-threaded regulator, or make, or use, any adapter to convert from left to right-hand thread.
- 30.26** Before fitting a regulator, dirt and grit should be blown out of the cylinder mouth by quickly opening the valve about a quarter of a turn and closing it again, great care being taken that no flame, hot metal, sparks, or smouldering material is in the vicinity. When fitting the regulator, extreme care is needed so that the bull nose of the regulator is clean and the wing nut tapped tight home to make a gas-tight joint.
- 30.27** Acetylene has a very pungent odour, and it is possible to smell it round the valve joint as soon as the cylinder valve is turned on. Any leak should be stopped by further tightening before using, as a stray spark may ignite a leak and cause heating and possible explosion of the cylinder. Acetylene leaks should never be tested with a flame.
- 30.28** Acetylene cylinders should be handled even more carefully than oxygen cylinders and kept away from heat, sparks, fires and electric cables, the blowpipe flame and sparks and slag from cutting. Cylinder valves must always be closed before removing the regulator. Under no circumstances should an acetylene cylinder valve be left open, or leaking, as acetylene and air form an explosive mixture.

#### *Regulators*

- 30.29** The regulator (Fig. 136) is a sensitive instrument working on a balance of gas pressure pressing on a flexible diaphragm in opposition to a pressure regulating spring (5). A pin projecting through the valve nozzle from the moving valve (10) is held in contact with the head of the diaphragm screw (9) by the resisting spring (23), consequently any movement of the diaphragm (8) causes movement of the regulating valve (10). It therefore follows that if the regulator screw (3) is screwed "in" it will through the spring (5) apply more pressure to the diaphragm (8) and cause it to move forward and open the valve (10) more, thus allowing a greater flow of gas and consequent increase of pressure blowing to the blowpipe through the outlet stop valve controlled by hand wheel (27). In like manner screwing the regulating screw (3) "out" will relieve pressure from the diaphragm (8) and reduce the delivery pressure.

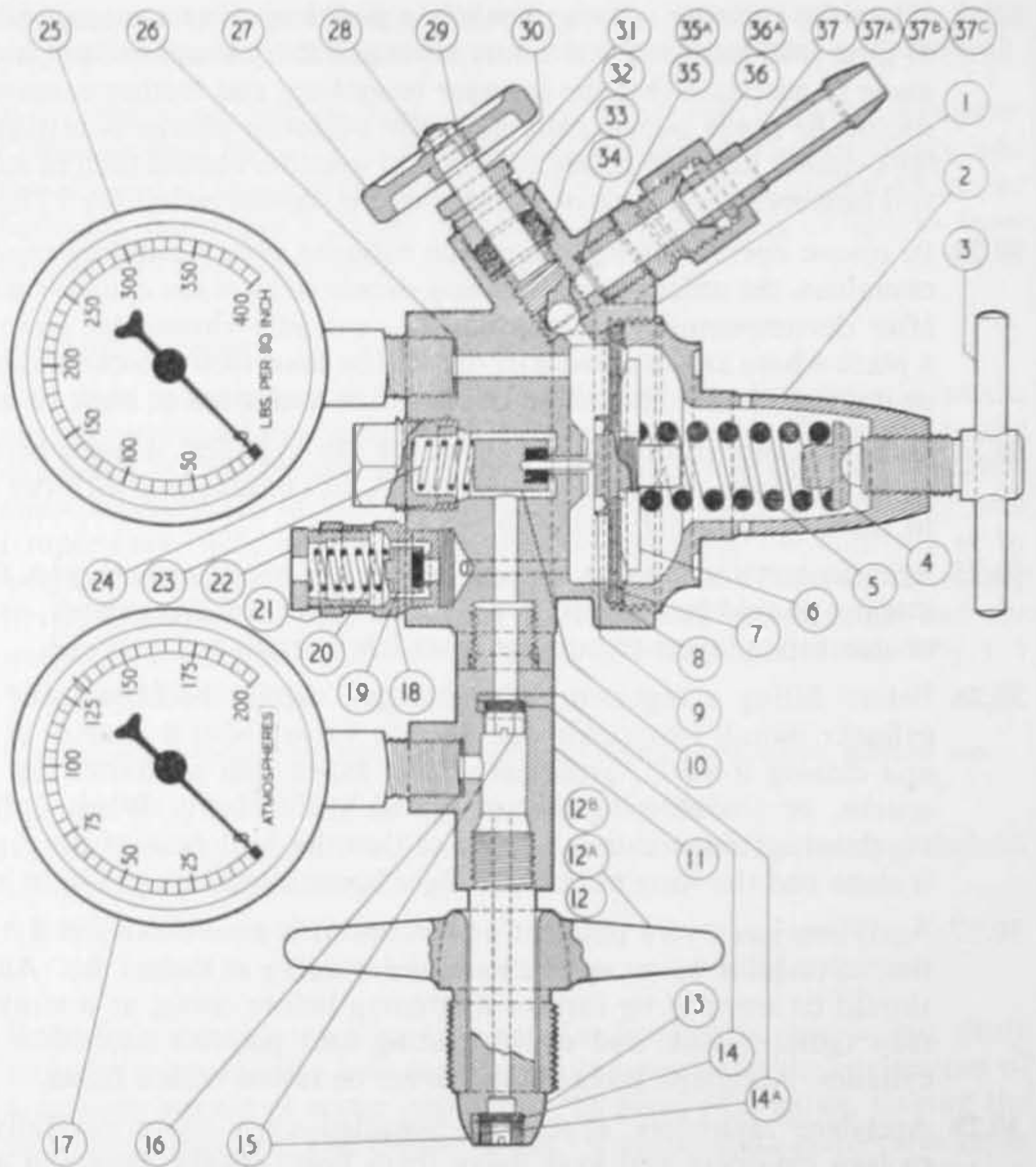

Fig. 136. The regulators

(1) Body. (2) Spring Cover. (3) Pressure Adjusting Screw. (4) Main Spring Boss. (5) Pressure Adjusting Spring. (6) Diaphragm Plate. (7) Slip Ring. (8) Diaphragm. (9) Diaphragm Screw. (10) Main Valve (complete with Pin). (11) Inlet Tee. (12) Bottle Nut (Wing). (13) Bottle Sleeve. (14) Filter Gauze. (14a) Felt Filter. (15) Felt Nipple. (16) Gauge Joint Washer. (17) Contents Pressure Gauge. (18) Safety Valve Body. (19) Safety Valve Seat. (20) Safety Valve Spring. (21) Safety Valve Lock Nut. (22) Safety Valve Adjusting Screw. (23) Main Resisting Spring. (24) Retaining Nut for Resisting Spring. (25) Delivery Pressure Gauge. (26) Gauge Joint Washer. (27) Hand Wheel. (28) Outlet Valve Spindle Nut. (29) Valve Spindle Key. (30) Outlet Valve Spindle. (31) Outlet Valve Gland Nut. (32) Outlet Valve Packing. (33) Outlet Valve Gland Washer. (34) Joint Washer for Outlet Nipple. (35) Outlet Nipple  $\frac{1}{2}$  in. B.S.P. (36) Outlet Union Nut  $\frac{1}{2}$  in. B.S.P. (37) Hose Connection.

30.30 From this it will be seen that it is in effect an extremely sensitive balancing device and should consequently be treated with all possible care if it is to maintain its accuracy.

30.31 Any dirt reaching the main regulating valve (10) is liable to cause this to become leaky, in which case the pressure will creep up on the delivery

side when the blowpipe is shut off and may burst the hose and will in any case waste gas through the safety valve (19). Also the irregularity in pressure caused by a leaky regulating valve makes cutting difficult if not impossible, so it is important to take care that the regulator is not put down in dust or mud, when not in use, or when changing it over from one cylinder to another. Oil or grease must never be used on the screw threads, or any part of a regulator, as it may cause serious danger.

- 30.32 The regulator is screwed into the cylinder mouth by hand, after seeing that the bull nose is clean, and tightened home with a few taps on the wing nut. Acetylene connections have left-hand threads, and oxygen connections have right-hand threads.
- 30.33 After a regulator has been fitted to a cylinder and before opening the cylinder valve, the pressure adjusting screw (3) is screwed in until it is felt that it is slightly compressing the spring (5). The outlet valve (27) is opened as is also the appropriate valve on the cutting blowpipe, if it is connected up. This will ensure that when the cylinder valve is opened the gas can pass through and a sudden rise in pressure is thus avoided. The cylinder valve is opened slowly by tapping the cylinder key with the hand and, as soon as the cylinder contents gauge ceases to rise, opened about three full turns. The regulator outlet valve, or the valve on the cutter, is closed, and all connections tested to see that they are gas tight. When turning on the cylinder valves the cutter is kept away from any naked flame, hot metal, or smouldering material.
- 30.34 The pressure can only be adjusted when gas is flowing through the cutter; to do this the regulating screw (3) is screwed "in" to increase pressure and "out" to reduce pressure.

#### *Hoses*

- 30.35 The ends of hoses should not be dropped into mud or dust as any dirt in the hose will be driven into the cutting blowpipe and may cause choking of the small gas passages. The bull nose connections in the end of the hoses must be clean before connecting to the regulator, and the spanner must be used to nip the nuts up tight to prevent leakage. Red hose with left-hand screw thread connections should be used for acetylene, and black hose with right-hand threaded connections for oxygen.
- 30.36 It is advisable to blow gas through the hose before connecting up to the cutting blowpipe if this can be done at a safe distance from any flame, hot metal or smouldering material.
- 30.37 Great care should be exercised to see that hoses are coupled up "gas tight" particularly when working in confined spaces. An oxygen leak is as dangerous as a fuel gas leak, because it may cause clothing to burst into flame if a spark settles. The hoses should be kept clear of hot metal that has just been cut and not dragged over sharp and jagged material.

#### *The cutting blowpipe*

- 30.38 With one type of cutting blowpipe the faces of the valve control wheels

are painted maroon for acetylene and black for oxygen to assist correct coupling, but the screw threads are also left hand for acetylene and right hand for oxygen to prevent mistakes.

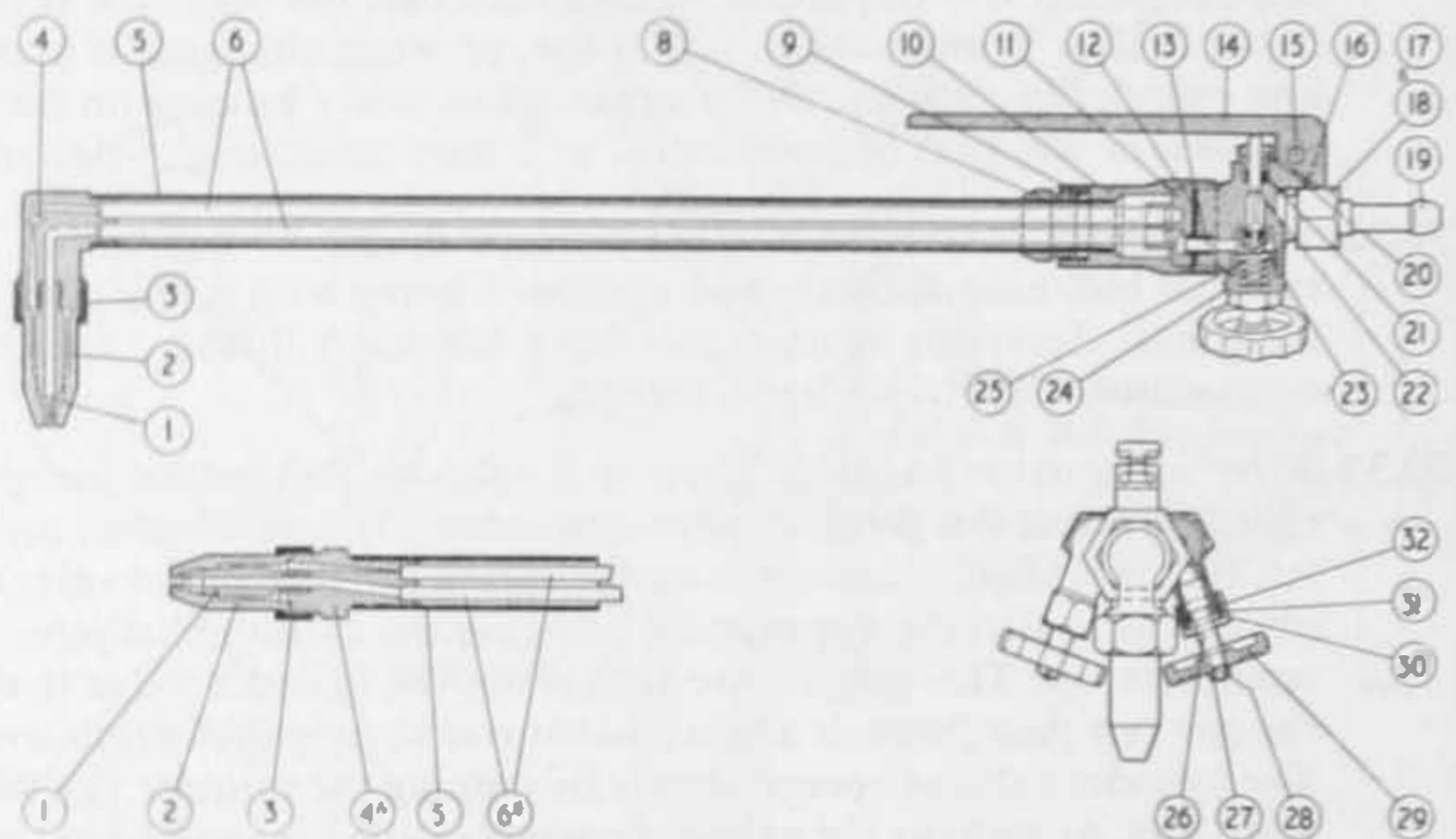

Fig. 137. One type of cutting blowpipe

(1) Inner Nozzle. (2) Outer Nozzle. (3) Head Union Nut. (4) Elbow Head. (4a) Straight Head. (5) Main Tube. (6) Heating and Cutting Oxygen Tube (two). (8) Main Tube Sealing Nut. (9) Main Tube Sealing Ferrule. (10) Distributor Union Nut. (11) Distributor Block. (12) Distributor Joint. (13) Distributor Dowel Tube. (14) Cutting Oxygen Lever. (15) Cutting Oxygen Lever Taper Pin. (16) Valve Body. (17)  $\frac{1}{2}$  in. B.S.P. R.H. Union Nut, Oxygen. (18)  $\frac{1}{2}$  in. B.S.P. L.H. Union Nut, Acetylene. (19)  $\frac{1}{8}$  in. -  $\frac{1}{2}$  in. Hose Connection (two). (20) Cutting Oxygen Gland Nut. (21) Cutting Oxygen Gland Packing Rings. (22) Cutting Oxygen Valve Plunger. (23) Cutting Oxygen Valve with seating material. (24) Cutting Oxygen Spring Cap. (25) Cutting Oxygen Spring. (26) Oxygen and Fuel Gas Spindles (two). (27) Oxygen and Fuel Gas Nuts (two). (28) Oxygen and Fuel Gas Key Pins (two). (29) Oxygen and Fuel Gas Valve Wheels (two). (30) Oxygen and Fuel Gas Gland Nuts (two). (31) Oxygen and Fuel Gas Packing Rings (two). (32) Oxygen and Fuel Gas Gland Rings (two).

**30.39** Dirt or grit should not be allowed to enter the inlet sockets of the cutter when it is disconnected from the hose. When connecting the hoses, the union nuts are tightened with the spanner, the blowpipe being held in the hand. A vice is not necessary.

**30.40** The "splined" nozzles supplied with this cutter are self-centring so that an even flame will be produced so long as the slots down the tip of the inner nozzle are kept clean. Other nozzles can be used but care in centring will be necessary to ensure an even flame. Slacking off the head union nut and turning the outer will often rectify slight eccentricity with such nozzles.

**30.41** The two screw stop valves (29) below the body of the cutting blow-pipe, control the oxygen and acetylene respectively for the heating flame, while the lever (14) above the body controls the "cutting" oxygen. The heating flame is set to neutral, see Fig. 138, by adjusting the two stop valves. Depressing the lever permits the flow of the stream of pure oxygen which cuts, or burns, the already heated metal.

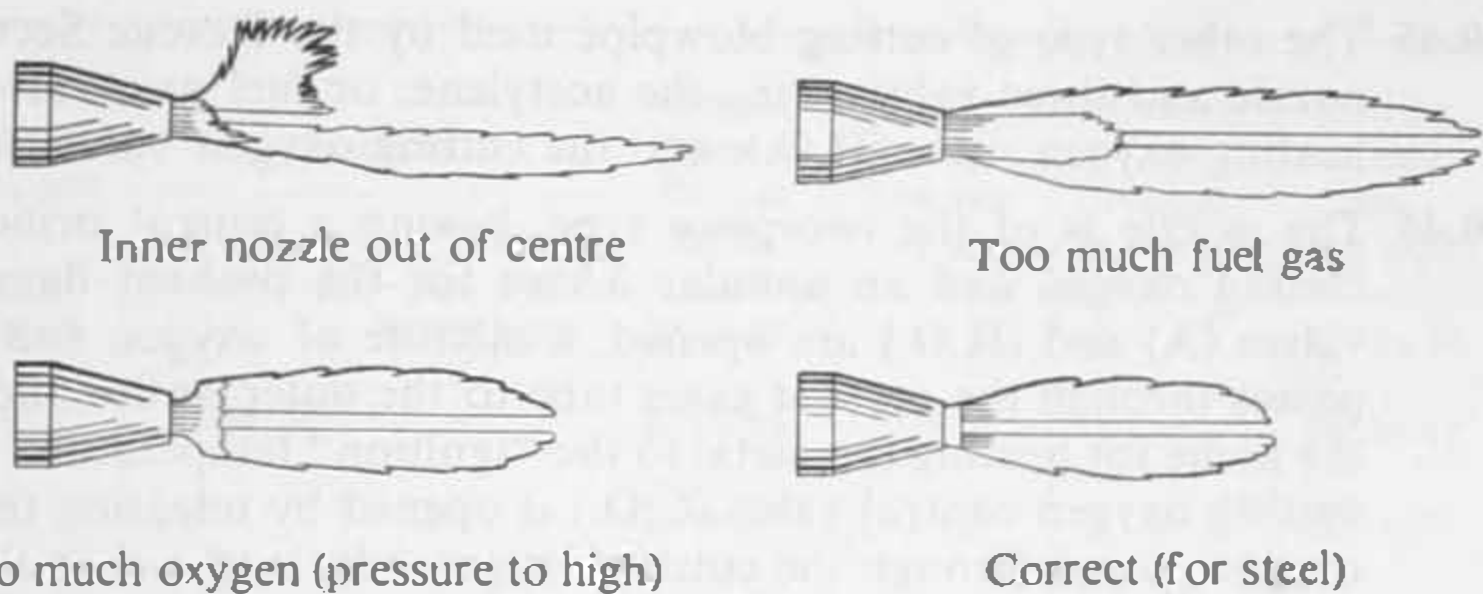

Fig. 138. Flame adjustment for cutting

30.42. If an intermittent popping occurs, or the flame is blown out when the cutting lever is depressed, it will probably be due to the inner nozzle, Fig. 137 (1) not being seated "gas tight" in the elbow head. The outer nozzle should be removed by unscrewing the head union nut (3), and the inner nozzle (1) and, after seeing that the face is clean, screwed in again fairly tightly with the spanner. Undue strain, however, must not be exerted or the nozzle may be broken off at the end of the screw thread. Should this occur no attempt should be made to remove the part with a file tang as it will almost certainly damage the seating and screw thread. Another possible cause of popping, or backfiring, is a leak at the distributor joint (12). This necessitates thorough overhaul of the cutter.

30.43 It will, from time to time, be necessary to tighten the gland nuts (20 and 30) of the valves to compensate for wear of the gland packing. Care must be taken that they are only tightened sufficiently to prevent leakage and that the free movement of the valves is not impeded.

30.44 A blowpipe must never be used as a flare for illumination purposes as the incandescent flame reflects its heat back on to the inner nozzle and may melt it away at the tip. If a nozzle should become burnt at the tip it must be renewed, as it will cause constant backfiring which will soon damage the blowpipe internally.

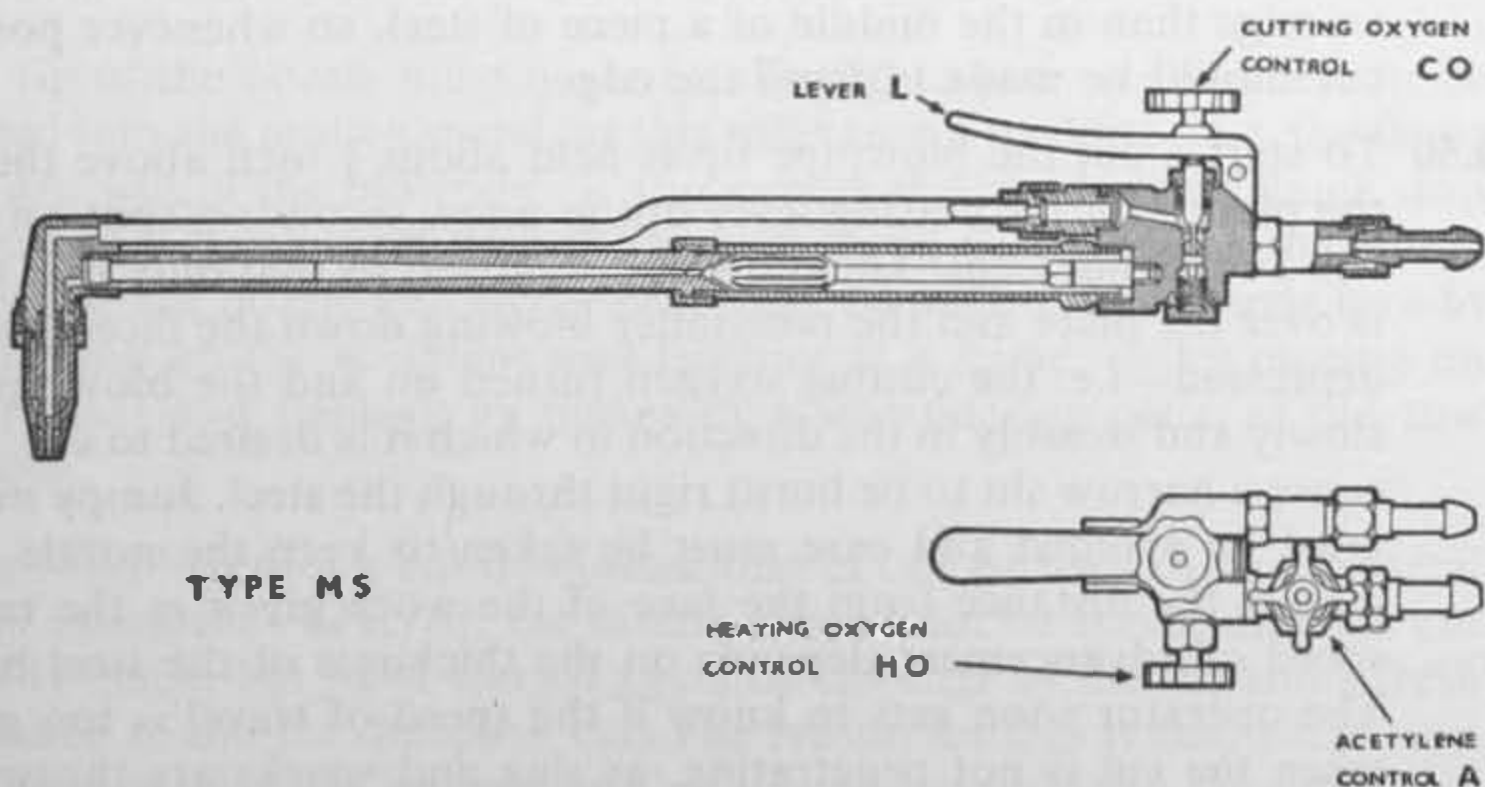

Fig. 139. Another type of cutting blowpipe

- 30.45 The other type of cutting blowpipe used by the Rescue Section has a nozzle and three valves, viz., the acetylene, or fuel gas, valve (A); the heating oxygen valve (H.O.); and the cutting oxygen valve (C.O.).
- 30.46 The nozzle is of the two-piece type, having a central orifice for the cutting oxygen and an annular orifice for the preheat flames. When valves (A) and (H.O.) are opened, a mixture of oxygen and acetylene passes through the preheat gases tube to the outer orifice and provides the flame for heating the metal to the "ignition" temperature. When the cutting oxygen control valve (C.O.) is opened by releasing the lever L, oxygen passes through the cutting oxygen tube to the central orifice of the nozzle, and providing the metal is preheated to the correct temperature, brings about the oxidation of the metal to effect the cutting action. The force, or velocity, of the oxygen is such that it blows away the oxidised metal and prevents it from fusing together again, thus forming a "kerf" or cut.

#### *Goggles*

- 30.47 Goggles should always be worn when cutting, as sparks of molten metal and oxide are liable to fly up on to the operator and may cause serious damage to the eyes. Such sparks pit the surface of the goggle glass and for this reason a plain cover glass is fitted in the goggles in front of the protective coloured lens. This cover glass should be renewed from time to time.

#### *The operation of cutting*

- 30.48 In preparing for cutting operations, the gases at the cylinder valves, regulator outlet valves and at the blowpipe are turned on. After it is ascertained that both gases are flowing, the oxygen valve at the blowpipe is closed, the blowpipe is lit and the oxygen valve turned on. The pressure of oxygen and acetylene should be set for the thickness of the steel to be cut in accordance with the following table. (This is done by means of the pressure adjusting screws (3) on the regulators. The oxygen pressure should be set when the cutting lever is depressed).
- 30.49 The flame is set to neutral, the final adjustment to the flame being made when the cutting lever is depressed. It is always easier to start a cut on an edge than in the middle of a piece of steel, so whenever possible the cut should be made in from the edge.
- 30.50 To start a cut the blowpipe tip is held about  $\frac{1}{4}$  inch above the edge of the plate with the cutting lever up; in a few seconds a spot on the edge will be incandescent. The blowpipe is moved so that only half the flame is over the plate and the remainder blowing down the face. The lever is depressed—i.e. the cutting oxygen turned on and the blowpipe moved slowly and steadily in the direction in which it is desired to cut. This will cause a narrow slit to be burnt right through the steel. Jumpy movement must be avoided and care must be taken to keep the nozzle approximately the distance from the face of the work given in the table. The speed of advancement depends on the thickness of the steel being cut. The operator soon gets to know if the speed of travel is too great and when the cut is not penetrating, as slag and sparks are thrown out of the cut.



Material Thickness	Nozzles		Oxygen Pressure lbs. per sq. in.	Acetylene Pressure lbs. per sq. in.	Distance of Nozzle from work	Cutting Speed ins. per min.
	Inner	Outer				
$\frac{1}{8}$ " to $\frac{3}{16}$ "	$\frac{1}{32}$ "	Small bore	20 to 27	1 to 2	$\frac{3}{16}$ "	22" to 14"
$\frac{3}{8}$ " to $\frac{5}{8}$ "	$\frac{1}{32}$ " or $\frac{3}{64}$ "	.. ..	27 to 35	1 to 2	$\frac{3}{16}$ " to $\frac{1}{4}$ "	14" to 11"
$\frac{3}{4}$ " to 1"	$\frac{3}{64}$ "	.. ..	35 to 45	1 to 2	$\frac{3}{16}$ " to $\frac{1}{4}$ "	12" to 9"
1 $\frac{1}{8}$ " to 2"	$\frac{1}{16}$ "	.. ..	45 to 55	1 to 2	$\frac{1}{4}$ " to $\frac{5}{16}$ "	9" to 8"
2 $\frac{1}{4}$ " to 3"	$\frac{1}{16}$ " or $\frac{5}{64}$ "	Large	55 to 65	2 to 3	$\frac{1}{4}$ " to $\frac{5}{16}$ "	8" to 7"
3 $\frac{1}{4}$ " to 4"	$\frac{5}{64}$ " or $\frac{1}{32}$ "	..	65 to 75	2 to 3	$\frac{1}{4}$ " to $\frac{5}{16}$ "	7" to 6"
4 $\frac{1}{4}$ " to 6"	$\frac{3}{32}$ "	..	75 to 80	2 to 3	$\frac{5}{16}$ " to $\frac{3}{8}$ "	6" to 5"
6 $\frac{1}{4}$ " to 9"	$\frac{3}{32}$ " or $\frac{7}{64}$ "	..	80 to 90	2 to 3	$\frac{3}{8}$ " to $\frac{7}{16}$ "	4 $\frac{1}{2}$ " to 3 $\frac{1}{2}$ "

**30.51** If a start cannot be made on an edge, a considerably longer heating period will be required to get the hot spot to a sufficiently high temperature to start burning. The lever should not be depressed and the cutting turned on until the metal is hot enough to burn, as it will only blow it cold. When a really incandescent spot has been made the nozzle is raised to about  $\frac{3}{4}$  inch from the metal and the blowpipe turned sideways to an angle of about 45 degrees and the lever depressed slowly. In this way the sparks and oxides will be blown away whilst piercing takes place instead of being blown up on to the operator. As soon as the metal is pierced, which will be known from the sparks no longer flying back from the hole, the cutter is straightened slowly and the cut proceeded with as usual.

**30.52** The lever is always released on finishing a cut, or moving position to continue a cut, as otherwise a ragged gash will be made and sparks will fly in all directions as the cutter is lifted from the work.

**30.53** The tip of the nozzle must never be allowed to rest on the work, or be dipped into the molten metal, as this will cause a backfire—i.e. the flame to burn within the blowpipe. If this occurs the two heating flame stop valves must be shut off with the utmost speed to extinguish the flame, otherwise the nozzle and elbow head may be melted. The nozzle is re-lit by turning on the acetylene and lighting at a flame, or by turning on both gases and lighting by means of a smouldering piece of old tow or rope.

**30.54** If on completion of a cut it is found that in one or two places the metal is not completely severed, the nozzle should not be thrust into the cut already made, but work started again on the edge of the cut and a fresh cut made round the defective cut. The reason for this is that while steel will burn, steel oxide will not, so that it is no use trying to burn down in the cut, which is probably filled with slag and oxide.

- 30.55 It is always difficult to start a cut on a round bar because there is no edge to heat. If possible a lip should be made with a round-nosed cold chisel, as this will give an edge to heat.
- 30.56 It is better to travel a little too slowly than too fast when cutting, for if the progress is too rapid the blowpipe will overrun the speed of penetration and places will be left not completely severed, or the cut will be "lost"—i.e. the steel in front of the cutting jet will not be incandescent and so will be blown cold by the oxygen stream instead of being burnt. Should this happen a recut on the edge of the old cut should be made so as to be sure that steel is being cut and no attempt being made to cut oxide and slag.
- 30.57 When work is finished the cylinder valves should be shut off and the pressure released from the hoses by opening the heating gas valves on the cutter.

#### *Backfire*

- 30.58 When cutting in the corners of angle irons and other such places, the flame is thrown back on the nozzle of the blowpipe, which becomes overheated and may backfire. If possible, a bucket of water should be at hand so that the cutter can be cooled by immersing it in water, with the heating oxygen valve just "cracked" so that a little gas is issuing to prevent the water entering the cutter.
- 30.59 If there is a defect in the cutter such as a split inner tube (6) or a leak at the distributor joint (12), a backfire may go back into the oxygen or acetylene hose and burst or burn it. In this case the blowpipe should be shut off at the cylinders and not used again until it has been thoroughly overhauled and tested. Charred or burnt hoses should not be used as the charred rubber and the gases released by the heat will almost certainly cause further bad backfires, even if a blowpipe which is in good condition is used.

#### *Notes and precautions*

- 30.60 (i) Do not use higher gas pressures than those given; it will slow down rather than increase the speed in cutting. Set the pressures when gas is flowing.
- (ii) Always be careful that the equipment is coupled up properly and that there are no leaks.
- (iii) Always remember that left hand threaded nuts have a groove in the middle, and right hand nuts are plain. Left hand threads are used for acetylene and other fuel gases; right hand threads are used for oxygen.
- (iv) Use no oil, grease or fatty substance and keep all equipment away from contamination by such substances. A mere smear of oil on oxygen equipment can, in contact with high pressure oxygen, cause serious accidents.
- (v) If the blowpipe is lit at a flame or by a spark lighter it is best to turn on only the acetylene and afterwards turn on the oxygen. If it is lit at a piece of smouldering rope or tow, the oxygen also must be turned on slightly.

- (vi) If the flames snap out when lighting, or when cutting, immediately close the heating oxygen and fuel gas valves for a moment to extinguish the flame inside the cutter, then open and re-light.
- (vii) Keep the nozzles clean and free from incrustations of slag. Scrape these off carefully.
- (viii) Do not use the blowpipe as a hammer, or lever, to break away slag which is holding a cut plate.
- (ix) Take care to work in such a way that on completion of a cut the cut piece cannot fall and cause injury, nor can it release debris which may cause danger.
- (x) If cutting has to be performed near a trapped person, protect him with asbestos or other suitable material against being burnt by sparks and slag.
- (xi) When cutting bars in reinforced concrete, the heat will cause the concrete to flake and fly with great force, so take precautions to avoid cuts and burns.
- (xii) If a blowpipe will not burn properly it may be due to a cylinder valve being only slightly opened, a regulator outlet valve being only partly open, or a cylinder being empty; try the valves and observe the pressures shown by the contents gauges before putting on new cylinders.

#### *Cutting metals other than mild steel*

- 30.61** Stainless steel, when incandescent, will splutter but will not cut. Thin sections can be melted away by the flame only.
- 30.62** Thin brass, copper, and aluminium can be melted away by the flame only but cannot be cut. The flame is set as large as possible and the blowpipe held at an angle of about 20 degrees to the surface and moved slowly forward as the metal melts in front of it.
- 30.63** Cast iron can be cut by a special technique. The flame is set as large as possible with a feather of excess acetylene about 1 inch long. Heating is done not merely at the top edge but down the face to be cut until the piece is well heated. When heated to incandescence at the top edge, the cutting lever is depressed and work carried out in a semi-circle with about  $\frac{3}{4}$  inch diameter and weaving across the line of the cut, each complete cycle taking about ten seconds. On each pass a bite back about  $\frac{1}{2}$  inch to  $\frac{1}{4}$  inch is made in the direction of the desired cut. This slow movement allows time to break down the graphite and maintain a hot spot. There is a tendency for a shelf of slag and graphite to form about  $\frac{3}{4}$  inch down in the cut, and it is only by swinging with the very slow semi-circular motion on to the sides of the cut that this can be made to break away so that the cut can penetrate. Practice is necessary to maintain the cut and in any case the speed of progress is extremely slow as compared with steel cutting, while the width of the cut made is from  $\frac{3}{4}$  inch to  $1\frac{1}{4}$  inch wide and is very irregular.

## PART III. OPERATIONS

### CHAPTER 31

## Briefing

#### Definitions

- 31.1** *Briefing* is the term used to signify the giving of orders or instructions by which the course of action decided by controllers is communicated to services placed under their control or in their support.

#### Importance of good briefing

- 31.2** Success in any operation involving action by others depends very largely on the clearness and conciseness of the orders by the person ordering that action and the manner in which the orders are given. Good orders, well delivered, have a high morale value for those affected: the converse is equally true and nothing contributes so speedily to inefficiency and lack of confidence as bad orders hesitatingly given. Briefing is a responsibility not only of controllers, or of members of their staffs acting in their name, but also of commanders of services giving executive orders to their own personnel. It is, therefore, of the highest importance that the points dealt with in the succeeding paragraphs be borne in mind by all leaders wherever they may be in the chain of control and command.

#### The object of briefing

- 31.3** The object of civil defence briefing is to ensure accuracy, speed and economy in the deployment of services to life-saving tasks.

#### Build-up of an order

- 31.4** An order develops logically from the following sequence of thought:
- (a) Appreciation of the situation based on the information available and the deductions made therefrom.
  - (b) The plan decided on from the various courses of action suggested by those deductions.
  - (c) Translation of the plan into the approved form and sequence of an order.

#### Methods of issuing orders

- 31.5** An order may be issued:
- (a) by a formal written order;
  - (b) in message form;
  - (c) by an authorised representative of a controller, e.g., a staff officer;
  - (d) verbally by a controller at his own or at a subordinate headquarters or rendezvous, or by telephone or R/T.

Of these methods the most probable in civil defence operations is the verbal order given personally by the controller. It is not only the most probable, but by far the most desirable, for a controller or a commander can impress his will on, and inspire confidence in his sub-ordinates more easily and effectively by verbal orders than by written orders or messages prepared by his staff. The morale effect of good orders delivered determinedly can be very considerable. Whichever method is adopted the principles are identical: the type of order dealt with below is the verbal order.

### **Essentials of an order**

**31.6** The essential ingredients of a good order for operations are:

- (a) It should contain only such information relevant to the situation as the recipient needs to carry out his task.
- (b) It must be unmistakably and unequivocally clear regarding the tasks to be done.
- (c) It must be expressed in the minimum of simple words.
- (d) It must be arranged in the approved sequence.
- (e) It must be thought out on the above lines *before* delivery.

### **Arrangement of an order: the importance of sequence**

**31.7** At Appendix E is the approved list of main headings and sub-headings to be used in arranging an order. This list follows an accepted order of sequence which must be observed. Briefing is a two-way process of giving and receiving, both of which are made easier if both parties are trained to anticipate the contents of the order in an accepted sequence. Correct sequence, too, is a valuable aid to ensuring that the order develops logically, omits nothing essential and includes nothing superfluous.

### **Main headings of an order**

**31.8** Essential information will be grouped under five main headings, nomenclature and sequence being common to all members of N.A.T.O. These headings are:

*Situation*

*Mission*

*Factors affecting the mission*

*Administration |logistics*

*Command and signal*

- (i) *Situation*. The commander reporting for orders is unlikely to have much knowledge about what has happened and may often be a complete stranger to the locality in which he is to act. The aim of the *Situation* paragraphs is, therefore, to give him a description, in very general terms, of the situation in the locality as a background to the tasks required of him. The situation paragraphs are not the place for details.

- (ii) *Mission*. The essential in an order is that it must be crystal clear regarding the tasks to be undertaken. These tasks must be listed in order of priority and be stated in clear, concise terms.
- (iii) *Factors affecting the mission*. It is not the business of the giver of an order to tell the recipient how that order is to be executed. But, so that the recipient can frame his own orders for the execution of the tasks to be done, he must be given full information on all factors affecting these tasks, including information of the situation on route to the area into which he is to move. The distribution between the *general* information under *Situation* and the *detailed* information under *Factors* will be readily apparent from a study of Appendix E.
- (iv) *Administration/logistics*. Policy regarding the administration and maintenance of civil defence forces in action or elsewhere is not yet available, but it may be expected that this heading will include such matters as feeding, reliefs, quartering, equipment replenishments, transport.
- (v) *Command and Signal*. Details of the location of control headquarters with whom the recipient is likely to be working, any special communications arrangements affecting incoming services, liaison, reports, etc.

#### **Use of sub-headings in an order**

31.9 The list of sub-headings is both comprehensive and exhaustive, and it should be obvious that there will be no need to use, for every order, all the items listed. Use only those items that are necessary for providing information essential for the efficient execution of the tasks to be carried out. Below sector level, it should rarely be necessary to use more than a few of the items; an example is given in Appendix F which should be studied in conjunction with paragraph 31.11.

#### **Importance of pre-thought before briefing**

31.10 A frequent cause of bad briefing is that the giver tends to rush matters without being clear in his own mind about what he intends to say and the sequence in which he intends to say it. It cannot be emphasised too strongly that the complete order must be thought out before any attempt is made to start briefing. If this is not done the sequence will be illogical, irrelevancies will creep in, delivery will be hesitant, time will be wasted and the recipient will be left with a hazy idea of what is required of him when the briefing is over. It is not always realised that this process of quiet thought while preparing an order has an additional value in that it tends to bring under control any excitement, anxiety or nervousness the giver may feel. It is of great importance in promoting confidence in the command that the giver of an order, whatever he may be feeling inwardly, should outwardly appear completely calm, collected and confident—quite unperturbed by what may be going on around him.

#### **Briefing below sector level with particular reference to rescue units**

31.11 The preceding paragraphs have dealt with the salient points regarding briefing in their application to all levels of control and to all services.

In particular, it has been stressed that only that information should be included in orders which is essential to the efficient execution of the tasks given. If life-saving units, e.g., rescue and casualty collecting personnel, are being sent on by a control to work under another control at a lower level then the initial briefing should be limited to directions for reaching the lower control. It follows that the nearer the tasks the greater the detail. Life-saving services may therefore expect to receive fuller details regarding their tasks as they advance through the chain Sector Warden—Post Warden—Senior Warden, complete details being obtained finally at the lowest level of control i.e. Senior Warden. An example of the briefing of rescue personnel advancing through this chain is given at Appendix F. It should be noted that this example, while adhering to the form laid down in Appendix E, selects from the sub headings only those which are considered necessary for the briefing of rescue personnel at Post Warden and Senior Warden level in the particular circumstances depicted. The example given may usefully be staged as a demonstration during training.

### Hints for the giving of good verbal orders

- 31.12** The delivery of good verbal orders is a technique which can only be acquired by practice. While all givers of orders are required to follow the chain of thought, sequence and headings already described, it is in the actual delivery of the order that the technique of the individual giver is developed. On no occasion will he have such an opportunity of impressing his personality on subordinates as when he is giving verbal orders. Some *Do's* and *Don'ts* when giving orders are listed below.

#### Do's

- 31.13**
- (a) Address yourself to one commander or leader only. There is no objection to his subordinates listening in for this may well save time when the commander comes to give his own orders, but it should be made quite clear that these subordinates are listeners only.
  - (b) Treat the recipient as an intelligent man, whatever his grade or type. The fact that he is a commander, however lowly his grade, proves that he has shown qualities meriting promotion to a position of leadership. On the other hand, do not be overawed by the high rank of a commander.
  - (c) Put the recipient at his ease; it is not necessary to keep the recipient at "Attention" when giving an order. He may well be tired and will appreciate the consideration shown to him.
  - (d) Be businesslike, firm and courteous, no matter how high or low ranking the recipient may be.
  - (e) Pay attention to speed of speech. Speak at a steady rate and do not gabble. The recipient may well want to make brief notes.
  - (f) It is advisable to allow no interruption during the course of a briefing. Interruptions tend to break the trend of thought and may well lead to discussions which not only waste time, but confuse the whole purpose and sequence of the briefing. The

recipient will be given an opportunity to clarify any points not clear to him when the giver invites questions at the end of the briefing.

- (g) When briefing, look the recipient in the face. There is nothing to be ashamed of or to apologise for in giving an order. Study of the recipients face will help the giver to assess whether the briefing is being understood or otherwise.
- (h) Remember that an order is an order and not a subject for discussion. The giver of an order is entitled to give it, he has thought it out, he has delivered it and, by so doing, has accepted responsibility for it. Nothing contributes so quickly to lack of confidence in and respect for a commander as his readiness to chop and change his orders in consequence of discussions or opinions interjected by recipients of those orders. There is one exception to this rule, and that is the scope of the mission. In fixing on a mission the tendency is often to ask for more to be done than the services available can deal with adequately for *technical* reasons. Many Controllers and Staff Officers will not have the technical experience necessary to assess what task is fair and reasonable. In these circumstances it may be necessary to agree with the commander concerned on what his forces can undertake, and to modify or increase the tasks accordingly. But the time for this discussion is after questions have been invited and *not* in the course of the briefing.
- (i) Whenever possible, orders should be given where the ground can be seen. Words and time are saved and accuracy ensured by being able to point to rather than describe and, since briefings should be given in the minimum possible time, accuracy and time saved means lives saved. Maps and plans should only be used when the ground and the task areas on it are not visible.

### **Don'ts**

- 31.14 Don't be pompous, don't hector, don't bully, don't be apologetic, don't cringe and don't doubt your ability to give an order.

### **Training in briefing**

- 31.15 It must not be forgotten that *all* leaders from Regional Commissioners (or Zone Controllers in Scotland) to deputy party leaders will have to give orders at some stage or other in civil defence operations. Briefing is not the prerogative of the control only, but of leaders in all grades in all sections. Training in briefing is, therefore, just as important as training in other civil defence subjects. Some suggestions for this training are given in Appendix H.



## CHAPTER 32

### The Rescue Plan—Stages of Rescue

- 32.1** The size of the area in which a Civil Defence Corps rescue column will be deployed depends on the circumstances at the time, but generally speaking a column would be wasted if it were to be allocated lower than a sector, and is unlikely to be usefully employed as a column higher than a Sub-area. It is considered that in most circumstances the column might be more usefully employed allotted to a Sub-area with each of its companies being allotted to a sector, although there will be occasions when it will be necessary to use one complete column in one sector area. Similarly it is reasonable to suppose that in a large town or city to which only one column is allotted, one or more of its companies will have to be more widely separated.
- 32.2** It is a complicated problem and the area involved will depend on
- (a) The number of types of buildings in the area and the density of population at the time of attack.
  - (b) The extent of the damage.
  - (c) The extent and dose rate of the residual radioactivity.
  - (d) Whether or not the area or areas are threatened by fires and therefore whether or not as much of the whole area as possible must be covered quickly.
- 32.3** The allocation of tasks and their priorities is the responsibility of the various levels of control and must be accepted without question. The technical direction is the responsibility of the various levels of command in the rescue column. It is with this picture in mind that the organisation of the Rescue Section is planned.
- 32.4** Successful rescue work depends principally on two things: firstly, a quick but thorough appraisal of the situation by the person in charge (whether it be Column Rescue Officer, Company Rescue Officer, Platoon Rescue Officer or party leader) plus a systematic working plan which gives a flexible but reliable guide for successful operation. The appraisal is termed "Reconnaissance" and the guide "The Rescue Plan".
- 32.5** The type and scope of the reconnaissance will vary according to the level of briefing and the scope and size of the task involved. Just as the more detailed the briefing the lower the chain of control, so the more detailed the rescue reconnaissance the lower the level of rescue command. This chapter deals with rescue reconnaissance from the point of view of the rescue party leader. It is detailed in full as it is the basis of all good rescue, for once a man has learned and mastered the techniques of handling and using equipment it is of paramount importance that he

knows how to properly put these techniques into operation. First class rescue reconnaissance brings successful results and that point cannot be over emphasised throughout all stages of training.

32.6 At the same time it must be stressed that the magnitude of the task and the limiting time factor in which maximum results can be obtained calls for a rapid assessment throughout. Rescue reconnaissance is allied to all stages of the rescue plan, but there is no suggestion that all the stages referred to more fully in succeeding paragraphs must be followed rigidly; the "five stages of rescue" are a guide, but it is more than likely that where a megaton weapon has exploded the Rescue Section will be primarily concerned with the second, third and fourth stages. It is indeed doubtful if stage five (general debris clearance) will be called for until such time as the whole area is cleared.

32.7 As explained in paragraph 2.10 the rescue plan would always need to be flexible in order to ensure that rescue personnel did not exceed the permissible war-time emergency dose of radiation unless, exceptionally, a higher dose were authorised to enable them to complete an important task already in hand. The arrangements for the control of civil defence operations under fall-out conditions are described in Civil Defence Training Memorandum No. 3 (in Scotland, Civil Defence General Training Bulletin No. 5).

#### **Initial reconnaissance**

32.8 It will be appreciated that, in every plan of action, reconnaissance (i.e. information and observation) is an essential preliminary. The party leader's reconnaissance is in effect an attempt to arrive at an accurate assessment of the numbers and whereabouts of casualties. It is essential that every member of a rescue party should be thoroughly grounded in rescue reconnaissance as in many instances, especially where large areas of damage are being dealt with, the leader of a party may be responsible for a considerable number of buildings and men deployed by him must be able to do their own reconnaissance of the task on which they have been set to work.

#### *Information*

32.9 Normally the initial information to the leader will be given by a Senior Warden and possibly more detailed information by a warden on the spot. Apart from this, or in addition to these sources, the leader and members of the party may obtain valuable information from reliable witnesses, e.g. police officers, relatives, neighbours and indeed from casualties, and all such information will prove valuable to the leader.

32.10 In certain cases, especially in large scale damage by modern weapons, the leader may be directed to definite tasks, e.g. a position where large numbers of people are known to seek shelter or congregate together, or where people are endangered by the spread of fire, or any other hazards.

#### *Observation*

32.11 Having deployed members of his party to such "priority" tasks as may have been assigned to him, the leader will make a quick but thorough

reconnaissance of the whole site allotted to him so that he can obtain a clear picture of the nature and extent of the damage and best organise the work of his party and take steps to re-deploy as necessary.

**32.12** During this reconnaissance he will be checking or picking up information on any complicating factors such as danger from coal gas, flooding of basements, over-hanging walls, etc. which may endanger either casualties or his party. This would undoubtedly influence him in assessing priorities from a technical point of view. It would also ensure that casualties in need of urgent medical attention are removed from the site before those whose need is not so great.

**32.13** Men deployed on a particular building must make careful observation of how that building has collapsed. This should be done in the light of any information available concerning probable casualties. First some attempt should be made to locate and identify the parts of the building and especially those parts in which casualties are reported to be. This will enable a rough idea to be obtained as to where casualties might be found in relation to the various parts of the damaged structure. This process of translating information with reference to the undamaged building into terms of the damaged building is the most difficult and certainly one of the most important parts of technical rescue reconnaissance for it is only from this that any effective plan of action can be built up.

**32.14** The art of rescue lies in being able to identify and exploit to the maximum all debris formations such as voids, etc. which can be used to facilitate access to the casualty once his whereabouts has been fixed by information and inference. To be able to do this successfully will depend to a great extent upon careful observation on the part of the leader, and each member of his party.

**32.15** The secret of efficient working is that every man should do the job for which he is best suited and that he should work to his full capacity. This is possible only if all leaders fully appreciate the capabilities of their men and co-operate fully to use each man to the best possible advantage.

**32.16** Most rescue work has to be conducted under conditions of great difficulty and confusion often made worse by darkness. As a result, it is usually difficult to form a true picture of the position and it is, therefore, highly important that rescue operations should be carried out systematically in stages and to a definite plan.

**32.17** On first approach, even the best leaders tend to over-estimate the difficulties owing to the appalling confusion, and the apparent magnitude of the job. This mental reaction is quite natural. And it is at such times that a leader requires to exercise all his qualities of coolness, perseverance and courage, and to make full use of the knowledge gained in his previous experience and training. At the same time, the party, to avoid harassing the leader, must display confidence in him and must help him, especially by remembering:

- (i) Not to ask unnecessary questions.
- (ii) Generally to give the leader advice only when he asks for it.

- (iii) To listen attentively, so that instructions need be given once only.
- (iv) To keep together on the job, and not to be missing when required.
- (v) To concentrate on the job in hand.

#### **Rescue by stages**

32.18 No standard set of rules can be devised to give leaders sure guidance on how to tackle every job, but by proceeding in stages according to a regular plan they are less liable to overlook important points, and are more likely to be able to appreciate and organise appropriate action. The principal of applying the art of reconnaissance to each successive stage will operate throughout. It is suggested, therefore, that rescue operations should proceed as nearly as possible by the following successive stages. They are framed so as to be generally applicable to any set of circumstances and to any rescue task from start to finish. They are easily memorised by reference to the *key headings*.

#### **Stage 1—Dealing with surface casualties**

32.19 Attending either to those who were outside buildings when injured or (what is much more likely) to the many slightly injured persons who will come out, should they be at all able, after the occurrence.

*Note.* The Rescue Section Party Leader will require:

- (a) to know from the Senior Warden that this has been done; or
- (b) to organise a general survey of the site to ensure that all surface casualties are dealt with.

(Generally speaking it is assumed that surface casualties will have been dealt with by wardens, casualty collecting personnel or others who have been trained in light or emergency rescue and first aid. If they have not been dealt with, the party must do this, giving priority to those in immediate danger).

#### **Stage 2—Immediate rescue and searching lightly damaged buildings**

32.20 This involves: (a) the recovery of those who are lightly trapped, and (b) the searching of slightly damaged buildings to ensure that no casualties within them are unattended. Once casualties have been seen or heard, or their whereabouts definitely ascertained, every endeavour should be made to maintain contact until they are released. In carrying out this stage, a speedy but careful examination of the damaged structures is needed in order to determine the best and safest approach. There is always the danger of fire owing to hot coals, etc. from open fires having been scattered by the blast. In houses where gas is used there is danger of gas poisoning and explosion owing to: (i) lights, stoves, etc. having been blown out by blast, (ii) house mains having been fractured by earth shock. It is for this reason that rescuers must not smoke or use naked lights when searching a building. Normally, the search should commence at the lowest portions of the building and be continued upwards until every room, and every possible position in which casualties may be has been explored.



Fig. 140. Surface casualties caused by the effects of an explosion



Fig. 141. Interior of slightly damaged building showing lightly trapped casualty

32.21 Slightly damaged houses should be marked when they have been searched and any casualties attended to (and removed if necessary).

*Marking buildings after search*

32.22 The objects of markings are to:

- (i) Save time and labour by indicating that the buildings have been searched for casualties and cleared.
- (ii) Indicate the service responsible for the search, e.g. wardens.
- (iii) Show if the building contains some particular danger.

Only slightly damaged buildings which have been thoroughly searched can safely be so marked and the following standard marking must be used. A capital letter 'S' chalked near the entrance will denote that the building has been searched and cleared of casualties. This will be underlined and underneath will be chalked the initial letter of the service responsible for the search, thus:

$\frac{S}{W}$  searched by Warden Section

$\frac{S}{F}$  searched by Fire Service

$\frac{S}{P}$  searched by Police

$\frac{S}{LR}$  searched by those trained in Light Rescue

$\frac{S}{R}$  searched by Rescue Section

Where searchers find dangerous conditions, e.g. leaning walls, damaged staircases, holes in floors, escaping coal gas etc. they should chalk the letter 'D' after the standard marking. Thus the symbol—

$\frac{S}{W} D$

means that the building has been searched by wardens and that dangers have been found, but could not be rectified at that time. This will warn others who may be sent at a later date (e.g. members of the Rescue Section, public utility company employees etc.) to rectify such dangers.

32.23 Buildings in which dangers exist should be marked in a prominent position on all sides where entry is likely to be made. In addition to the mark, a piece of board or some improvised barricade with the word "DANGER" chalked or written on it, or even string tied across an opening, will assist in warning anyone who has occasion to enter the building.

32.24 If debris is present in sufficient quantity to hide casualties, only mark those parts of the building which have been thoroughly searched.

### Stage 3—Exploration of likely survival points

**32.25** All likely survival points where persons may have taken refuge and in which they may be trapped, either injured or uninjured, must be searched. Too much stress cannot be laid on the need for searching all likely places for casualties who may still be alive, and of effecting their release before any attempt is made to rescue victims who have little chance of survival. This does not mean that every nook and cranny must be searched for possible casualties, but likely places must be fully explored.



Fig. 142. All likely places must be searched for casualties

Typical places include:

- (i) air raid shelter, inside and outside the building
- (ii) points near fireplaces and chimney breasts
- (iii) spaces and cupboards under staircases
- (iv) basements
- (v) voids under floors that have partially collapsed
- (vi) rooms not entirely demolished but from which exit is barred by debris

**32.26** It should be remembered that casualties may be found who have received severe crush injuries from fallen masonry, brickwork, beams, party walls, heavy furniture, etc. These persons will be suffering from shock and their breathing passages may be clogged by the dust contained in the debris, in which case these passages must be cleared. Persons suffering from crush injuries need special treatment before release if practicable.

### *Calling and listening technique*

32.27 When it is known that persons are still missing, and the rescuers are confronted with a major collapse of premises, the casualties may be trapped within the voids formed by the collapsing building. A "calling and listening" period should be introduced; this has in the past saved many lives and is carried out in the following manner:

The leader places such men as may be available at suitable vantage points around the area in which the persons may be trapped. He then demands complete silence and each man as directed by the leader calls "RESCUE PARTY HERE . . . CAN YOU HEAR ME?" All others listen intently for any reply. If none is heard it is a good plan to tap on a wall, or on any gas or water pipe, beam etc., running *into* the debris, all of which are good conductors of sound, and again listen for an answer. On hearing a reply, each listener points to the place from which he thinks the sound came, thus "pinpointing" the position. Once contact has been established with a trapped person it should be maintained, because:

- (a) It keeps up his morale and helps him to withstand whatever pain and discomfort he may be suffering, and may even help to keep him alive.
- (b) It helps the rescuers to decide on the best place at which to start and to work in the right direction, often a difficult matter, particularly in the dark.
- (c) The casualty, if conscious, may be able to give warning of any movement in the debris likely to cause him further injury.

32.28 No attempt should be made to move debris until a "calling and listening" period has been introduced with a view to pin-pointing the position of the casualties. Since the detection and location of sounds is a most vital clue to rescue section personnel, every sound, even if obviously made by animals, should receive investigation.

32.29 Conversation with a trapped person should always be of a reassuring nature, making light of the extrication work and encouraging him to talk about his own work, his friends or anything that will relieve his mind, rather than about his position or injuries.

### *Stages 1-3*

32.30 The work involved in the foregoing stages may frequently be done by those trained in light rescue or elementary rescue, working in teams, although in some cases they may require the assistance of fully trained rescue men to advise or even to *complete* a particular task, e.g. rescue from upper floors of badly damaged buildings, or of any seriously injured casualties etc.

32.31 One or all of the stages may be operated simultaneously according to personnel available and other circumstances.

### *Use of dogs*

32.32 Specially trained dogs were used with conspicuous success on a number of occasions during the later stages of the last war, and proved their



value as an adjunct to rescue reconnaissance, especially in the "third stage of rescue". A searching dog, trained to locate human scent, can lead to a very considerable saving of time and labour in the definite location and extrication of casualties. The dogs when brought to the scene of rescue operations can often quickly provide an indication of the position of a trapped or buried person which otherwise might take some time to determine by normal rescue reconnaissance methods. Highly trained dogs and handlers may well play an important part in rescue operations in any future war and their possible use has not been overlooked.



Fig. 143. A specially trained dog at work during rescue operations

#### **Stage 4—Further exploration and selected debris removal**

**32.33** If casualties are located, their recovery will entail removing debris from selected places, according to:

- (i) The location of the casualty.
- (ii) Information regarding the lay-out of the building.
- (iii) A careful study of the way in which the building has collapsed. See Chapter 19 "Rescue by Debris Clearance" for detail of methods adopted.

#### **Stage 5—General Debris Clearance**

**32.34** Where it is still impossible to account for all missing persons it may be necessary to strip the site methodically. See Chapter 19 "Rescue by Debris Clearance" for details.

## PART IV. MISCELLANEOUS

### CHAPTER 33

## Recovery of Valuables

#### Finding

- 33.1 It frequently falls to the lot of rescue personnel and others assisting them to find money and valuables. As a person who improperly retains any such property removed from bombed premises is liable to very severe punishment, it is most important that members of the Armed Forces, the Civil Defence Corps and the general public should clearly understand their responsibilities and liabilities in this matter.

#### Disposal

- 33.2 Any article of value, however small, found on bombed premises, must be handed over immediately to the party leader or section commander who will arrange for it to be given to the Senior Warden, Post Warden or to the senior police officer on duty.
- 33.3 The greatest possible care must be exercised in this direction. The only safe course is for the finder immediately to declare his find to his colleagues, and, as soon as possible, to hand the articles to a responsible officer, as mentioned in the preceding paragraph, and obtain a receipt for them.

## CHAPTER 34

### Procedure in Regard to the Dead

**34.1** The recovery of bodies from demolished buildings is one of the duties of a rescue party. Unless casualties (e.g. by reason of mutilation) are obviously dead, they should be treated by rescue parties as alive until death is confirmed by a doctor. If there is no doctor available, a rescue party leader should take the responsibility of confirming death in clear cases, but, wherever there is doubt, the casualty—to avoid delay—should be handed over to the Ambulance and Casualty Collecting Section, (in Scotland, the Warden Section).

#### Labelling bodies

**34.2** Bodies *must* be labelled as soon as they are recovered. The standard casualty label will be used and the front side completed. The following symbols to be entered on reverse side of label, are also applicable:

- (a) If body is contaminated or suspected of having been contaminated by persistent gas, label should be clearly marked with a "C".
- (b) For those suspected to have died from effects of poisoning by nerve gas or non-persistent gases, label should be clearly marked "XX".
- (c) For those suspected to have died from radioactive effects label should be clearly marked "R".

If possible, forehead of casualty should be marked with the appropriate symbol using indelible pencil.

#### Collection of bodies

**34.3** When bodies are recovered they should be deposited in the nearest convenient building and some suitable covering placed over them pending removal; they should not be left on the highway or in open space. The public and all persons not directly concerned should be kept away whilst bodies are being recovered.

**34.4** The dead should be treated with due respect, but priority must always be given to the living. Parts of bodies should be placed in metal bins, labelled in the manner already stated, to await removal.

#### Protective measures when recovering bodies

**34.5** Whenever possible, rescue workers who have to handle human remains should use the rubber gloves issued for the purpose. Where necessary, they should tie a pad or handkerchief, dipped in some deodorising fluid, over nose and mouth. Where such fluid is not available, wearing the respirator will help to overcome any nausea caused by foul smells.

## CHAPTER 35

### Carrying Heavy Loads

#### Lifting and carrying

35.1 Heavy loads will often have to be lifted and carried either by a single man or by a party. The proper method of lifting will prevent injury.

#### *One man loads*

35.2 The legs must do the work. The feet should be parallel and no further apart than the width of the hips. Bend the knees to grasp the object and raise it by straightening the legs. Avoid bending from the waist, and



Fig. 144. Correct method of lifting heavy objects

prevent strain in the muscles of the back and groin. Attend to the following important points and keep fit:

- (a) Position the feet, hip-width apart, one foot slightly in advance of the other.
- (b) Keep the back straight and the chin in, lower the hands by relaxing the knees.
- (c) Keep the arms close into the sides.

- (d) Use a broad palmar hold, and where possible, position the hands diagonally on the load—avoid parallel hands.

#### *Long loads*

- 35.3 For a long load such as a spar it is best to use two or more men and carry it on the shoulders with half the party each side of the load. One man should always take charge of such a lift and give the orders for lifting and lowering.

#### *Heavy awkward loads*

- 35.4 If the load is too heavy for the number of men who can obtain a useful grip on it, carrying bars will have to be used. The carrying bars may be inserted under or through the load, or through slings supporting it.

### **Use of carrying parties**

#### *Preliminaries*

- 35.5 (a) A leader must be detailed for all carrying parties; he should not take part in the lift if the carrying party is over four men.
- (b) The leader, before giving the party order to lift, should:
- (i) Make sure that there are sufficient men in the party to lift the load. Each man can lift between 56 and 90 lb. depending on the length of carry and the man's physique.
  - (ii) Size the party so that the smaller men are in front and divide it equally between each side.
  - (iii) Inspect the path of the carry and choose the smoothest route, avoiding changes of slope and projections which may catch the load.

#### *Practical details*

- 35.6 (a) It is only by the concerted effort of the whole carrying party on the leaders' word of command that each man can take an even share of the load and the load can be carried with the minimum effort. The first rule is therefore "Listen, and obey the leader's commands".
- (b) *Lifting.* The commands will be "Prepare to lift", "Lift". Men will keep their feet together, straighten backs and lift steadily. If the load is to be lifted on to the shoulders, it will be done in three stages, to arm's length with straight backs, to chest, and on to shoulders. The leader will give the time "Lift", "Up", "Up".
- (c) *Moving.* Commands will be "Forward", "Halt". The party must keep in step, and the leader must call it out. The step will normally be quick and the pace short. If only one hand is used in lifting, the other should be placed on the shoulder of the man ahead. It is a help to keep a regular rhythm, straighten-

ing the back at every sixth or eighth pace; the leader calls "Up" as the foot nearest the load comes to the ground. With very heavy loads, the leader should say how many paces will be taken between each rest, and then give the time for each pace.

(d) *Lowering.* Commands will be "Prepare to lower", "Lower". The preparatory order may be omitted at times. The party will lower the load gently. If lowering from the shoulders, do so in three stages: the commands will be "Inwards turn", "Lower", "Down".

(c) *Resting.* Rests should be given during a long lift or when lifting a very heavy load. A change of lifting arm or shoulder may be given by changing men from one side of the load to the other. The load should be steadied against overturning, rolling or sliding. during a rest.

## PART V. TRAINING

### CHAPTER 36

## General Principles and Organisation of Rescue Section Training

### Introduction

36.1 The paramount object of rescue is to save life, and this object is achieved by speedy release of those trapped and prompt application of the appropriate first aid in all cases of injury. It is from this angle that all rescue training should be approached. The more clearly men are made to appreciate exactly how each piece of instruction or practical skill they acquire will help their work of rescue, the more likely they will be to understand and remember the instruction they receive, whether it be theoretical or practical.

### General principles

- 36.2 Practical work should be the basis of all rescue training, with lecturing introduced only where necessary to give a clearer understanding of the practical side. Verbal instruction alone is of little value, nor is the demonstration an alternative to "doing it". Skill, discipline and team work combined with technical knowledge are required in rescue work, and these can only be obtained by actually doing, rather than just knowing how things should be done.
- 36.3 Each subject should be presented as part of the whole rescue operation and not as a separate entity. The main object in every case should be what is being done for the casualty. All exercises requiring or involving the Rescue Section should be looked upon by members of that section as rescue operations whether or not actual technical rescue work is involved.
- 36.4 Subjects should, as far as possible, be presented in a logical order. This preserves continuity of thought and gives a sense of progress, making training easier to follow and more interesting to perform.

### Training programmes

- 36.5 Every item of a training programme should be presented in the most practical manner possible on the principle that:
- (a) What a man DOES with his hands he understands and remembers.
  - (b) What a man SEES done by others he may remember fairly well.
  - (c) What a man HEARS described or spoken about he is liable to misunderstand and remember least.

- 36.6 No matter how elementary the point may be, it is always better to "show" than to "tell" in any kind of instruction. More particularly is this true of rescue training because, on the one hand, the subject is essentially a practical one and, on the other, the trainees are mostly men used to learning through using their hands.
- 36.7 Simplicity and clarity, both in demonstration and explanation, are the hall marks of good instruction. These virtues can only be acquired through careful thought, by preparation beforehand, and by keeping the object of the lesson clearly in mind. Academic and theoretical aspects of the subjects should be avoided as far as possible. They tend to confuse the mind, especially in the early stages of instruction.
- 36.8 It is for these reasons that so much emphasis must be laid on practical work during rescue training.
- 36.9 Added interest can be given to instruction by keeping the subject at local level, and introducing the names of those who form the chain of technical command within a man's own section, and within his own Division of the Corps. In many cases he may know those referred to by name e.g. the Chief Rescue Officer (Mr. Ladders) but to make the issue clear it is advisable to invite the particular officer to be present, even if only for a short space of time, on the evening on which this subject is being dealt with. The trainee then realises that the Chief Rescue Officer is not merely a shadowy figure but a real person under whom he will be working during operations.
- 36.10 Most of the men who take up the work of rescue are men accustomed to working with their hands, and once they have been shown how to do a thing, they naturally wish to try their hand at doing it themselves. Rescue is an art and must be learned, just as craft is learned, by following the teaching of men who already can do the work. Even in teaching the "general" or background subjects, the instructor should relate the teaching to the rescue point of view.

#### **Training of rescue men**

- 36.11 The syllabuses for rescue training cover such general subjects as the volunteer needs to know to ensure his personal safety or the safety of the unit to which he belongs, and to understand how the work of his section is related to that of the other sections and other Civil Defence Services, as well as the subjects necessary to make him an efficient rescue man.
- 36.12 In the initial stage he is not required to undertake more training than is necessary to enable him to carry out the duties of an ordinary member of his section. When he has completed this stage of standard training he will, if he wishes, and if considered suitable, be given further training known as advanced training either to qualify him for more responsible duties or to enable him to carry out some of the other tasks of his section.
- 36.13 All members who have completed standard training or advanced training for which they have volunteered, will be required to attend for refresher training each year and to take part in exercises.



## **First aid**

- 36.14** Rescue work and first aid are complementary and a sound knowledge of first aid is necessary if the technique of rescue operations is to be fully appreciated. For this reason every member of the Rescue Section must have a course in first aid and this training could be interspersed between the early sessions of the standard rescue syllabus.
- 36.15** First aid training is based on Civil Defence Pocket Book No. 1, "The Elements of First Aid", a book designed for all members of the Civil Defence Corps who may be called upon to give elementary first aid in an emergency, and the more detailed Civil Defence Handbook No. 6 "First Aid" which is intended for those who take the full first aid course.

## **Training of party leaders**

- 36.16** Only men who have completed both standard and advanced Rescue Section syllabuses, and who show signs of being potential leaders or deputy leaders, should be selected to attend the special course set out in the syllabus for the training of party leaders. At the end of the course they should be tested to ensure that they are capable of carrying out their duties.
- 36.17** Men undergoing this training should be given the opportunity to take charge of a party for practical work during this course. They should be encouraged to develop their personality as leaders and to give instructions clearly and firmly. In this way they will gain self-confidence and, when eventually they are in charge of their own party, the confidence of their men. In addition, they must be trained to use their technical knowledge and judgment.
- 36.18** Once leaders have completed their course and have taken their place as leaders of their own parties, it is a good plan for the officer in charge of the section to arrange regular meetings and discussions with those of equal grade or higher grade in the section (and at a later date with those holding similar or higher positions in other sections).

## **Training of rescue officers**

- 36.19** Rescue Section officers need a thorough grounding in the elements of rescue work. They must realise that the rescue of trapped persons from damaged buildings involves its own particular technique requiring careful study and a considerable amount of thought in its application. Special courses for officers of the Rescue Section are held at the Home Office Civil Defence Schools, where special attention is devoted to the briefing and deployment of rescue forces.

## **Instructors**

- 36.20** There are three Home Office Civil Defence Schools—at Falfield (Gloucestershire), Easingwold (Yorkshire) and Taymouth Castle (Perthshire)—for the training of Rescue Section instructors. It is considered that the highest standard of training can be obtained at a residential school of this kind, which is equipped with all the necessary training and instructional equipment, and a staff of experienced

instructors. It is, however, appreciated that some potential instructors may not be able to spare the time to attend the appropriate course at a residential school, and provision is therefore made for instructors courses to be arranged locally. Special short courses are provided at the schools for locally trained instructors who wish to qualify as centrally-trained instructors.

### **Demonstrations**

**36.21** Demonstrations should not be looked on as substitutes in any way for practical work. Reconnaissance techniques for example can be shown effectively by means of a demonstration, but it is always necessary to follow such a demonstration by practical work on similar lines.

### **Team work**

**36.22** Rescue is essentially an operation requiring a high degree of team work. From the beginning of their training, therefore, Rescue Section men should be impressed with the great importance of the team spirit which, in effect, amounts to helping one another in a common task. The team spirit can be fostered by:

- (i) forming men into teams or parties for even the most elementary training practice;
- (ii) appointing a trained leader to each party;
- (iii) allowing the natural team spirit in men to develop;
- (iv) preserving the identity of each party and avoiding, as far as possible, the interchange of individuals; this policy will encourage personal friendships within the party, and promote a better understanding between members;
- (v) comparing the standard or efficiency of one team or party with another.

## CHAPTER 37

### Refresher Training

**37.1** Experience has shown that it is very easy to underestimate the importance of refresher training. The idea that if parties are well trained in the first place no further training is necessary is not only wrong, but also very dangerous, leading in many cases to a false sense of efficiency. After rescue parties have been fully trained it is most important that they should constantly be kept up to date, and not lose touch with their instructors or lose their skill.

#### Exercises

**37.2** This is best achieved by refresher training in the form of exercises, starting with simple rescue problems and making them progressively more difficult until parties are able to take part in combined exercises with other sections of the Corps. Each problem should be designed on the assumption that the trainee has a knowledge of the rescue technique required, but needs to have his knowledge and skill practised and developed.

**37.3** Training exercises should be limited to aspects of rescue which can be dealt with thoroughly in the time available. They should be both interesting and difficult so that the skill, initiative and resourcefulness of the leader and his men is really exercised. They should be planned to perfect procedure even to the point of becoming automatic. As proficiency is reached the parties should work in increasingly difficult conditions, e.g. in darkness, until the men are able to co-operate efficiently with one another in carrying out difficult work quickly in silence and under adverse conditions. Quick work is to be encouraged, but accuracy must never be sacrificed for speed.

**37.4** Everything possible should be done to encourage friendly rivalry between the leaders as well as between the different parties. As each party becomes proficient in the execution of a given operation, it should be required to carry out the practice or exercise under the surveillance of the Head of the Section or of an officer. Marks should be awarded for leadership and performance so that the proficiency of various parties can be compared, and the parties at each area and in the whole of the Division can then be ranged in order of merit.

**37.5** The detailed planning of these exercises will depend on the facilities available locally. Advantage should be taken of all suitable local facilities for staging exercises in an interesting and realistic manner. The greater the variation of sites and types of premises that can be used for this purpose the easier it will be to sustain interest. However well the programme may be devised, it will require the constant effort of officers to maintain interest.

37.6 Some suggestions for refresher exercises are given in Appendix J.

*Preliminary explanation*

37.7 Before work is started on the problem set for a particular period of training, a very brief talk should be given on the problem set and its purpose. The interest and imagination of the men should be stimulated by a few appropriate questions, but this must not be allowed to develop into a discussion. Work must start as soon as possible after the explanation so that the lesson will be quickly and readily impressed on the minds of the men. A discussion on the lessons brought out should follow every exercise.

*Supervision and discipline during refresher training*

37.8 During refresher training as much of the detailed supervision as possible should be left to the leaders, acting under the general guidance of their officers and instructors. This provides training for both leader and men and will do much to weld the party into an effective operational unit. It is always better to train men as complete parties rather than as a collection of individuals, and the parties should, as far as possible, be made up of the men who will constitute the party in action.

37.9 The important function of officers and instructors is to improve the standard of work, correct mistakes, and generally smarten up the party.

**Exercises with other sections of the Corps**

37.10 A clear distinction must be made between the type of refresher training exercise designed to enable the men of a party to develop skill, initiative and team work, and combined exercises designed to introduce trained rescue parties to simulated war-time conditions, to bring out the essential need for inter-section co-operation and mutual understanding, and to present the sort of problems that arise at real occurrences. Parties should not be "thrown into" such exercises until they have been trained and found capable of working under their party leaders on problems set up for refresher training.

37.11 In combined exercises it is usually necessary, not only to provide for services other than rescue, but also to give as wide a range of work on the rescue side as possible. This can be accomplished most easily by introducing a large number of casualties, but it should be borne in mind that much more is learnt on the technical rescue side by having a few casualties who are difficult to get at, rather than a large number who can be easily recovered.

37.12 In staging any kind of practical rescue exercise the following guiding principles should be followed:

- (i) Use "live" casualties as the use of dummies does not develop the necessary care and is liable to make men over-confident.
- (ii) Casualties injuries should be faked, not indicated on a label attached to the casualty's body. The faking should be carefully done to imitate real wounds. A certain amount of acting by the "casualty" is necessary, but this must not be overdone.

- (iii) Always precede and follow practical work with a short period for explanation and questions.
- (iv) Make manual work as difficult as possible so as to bring out the resources of the parties. The difficulties should be similar to those which might be met with in a real situation.
- (v) Avoid "gymnastics" which have no bearing on ordinary rescue work.
- (vi) Try to arrange so that every man on the exercise is kept employed all the time. It is better, for this reason, to provide more work than can be done in the time available so as to avoid having men standing about.

**37.13** In staging a combined exercise there are two distinct aspects to be considered:

- (i) the actual rescue problem;
- (ii) the conditions under which this problem must be solved.

Both these aspects are important and require careful planning if the exercise is to have any real value. To introduce elaborate effects, for example, without any real rescue problem to solve may look spectacular, but achieves very little on the training side. On the other hand, unless the conditions under which the rescue work has to be carried out are sufficiently realistic, men will not get the proper mental outlook required for tackling the real job.

**37.14** The principal faults from which most staged exercises suffer are:

- (i) the position of the debris used is not that which would normally be found on a damaged building.
- (ii) the quantity of debris used for practice purposes is usually much less than would normally be found,
- (iii) the injuries the casualty has sustained are not what would be expected from the circumstances in which he is found.

**37.15** It is not always possible to overcome these difficulties but rescue exercises must be planned to approximate as nearly as possible to the conditions of a real occurrence as regards quantity and quality of debris, the presence of dangers and obstructions, and the general atmosphere of confusion and urgency which is a common feature of most occurrences in their earlier stages.

#### *Preliminary discussion*

**37.16** Every combined exercise should be preceded by a discussion by the Directing Staff on its object, the lessons to be learnt, and the general nature of the particular problems to be tackled. For combined exercises (as distinct from practices or demonstrations) details should not be disclosed to the men until the exercise is about to begin. The aim of all combined exercises is to train leaders and men to use initiative and common sense when faced with unexpected situations. Rescue personnel have so frequently to work in conditions of danger and difficulty that the necessary self reliance and enterprise can be developed only by regular practice drills and instruction designed to make certain essential procedures and safety actions a matter of automatic routine.

### *Use of tactical table*

- 37.17 Tactical tables used for showing the control, deployment and action of services can consist simply of a plan of an area, painted in matt colours, on a flat board. Some very elaborate tactical tables are in use on which burst water mains spout water and gas mains become ignited. Such realism has its value, but care must be taken that the attention of the trainees is not diverted from the object of the lesson, and the value of that period of instruction thereby impaired.
- 37.18 Exercises are staged on the model, with leaders and men in attendance. In the first instance, instruction is given in the manner of dealing with the exercise and with the problems presented. Subsequently, leaders and men are required to state their own actions and reactions in the situation present on the model. Types of damage and different forms of damage can be simulated in various ways; services, arriving and in action, can be represented by the placing and moving of model vehicles and personnel. Reports and messages concerning the situation and progress of the work can be devised as necessary. By these means, leaders can be effectively taught how to appreciate situations and problems likely to arise, and their operations sense should be markedly developed.
- 37.19 A tactical table can be effectively used for preliminary discussions concerning proposed combined exercises to be held at outdoor sites.

### *Sequence of events*

- 37.20 It is desirable at all staged exercises to go through the whole process in detail, including calling out, reporting through the successive control headquarters, checking-up the equipment after the work is completed, making out the leader's report, and reporting to the Senior Warden for further instructions on completion of tasks.









### *Final discussion*

- 37.21 All practical exercises should be followed by a discussion confined in the first place to officers and instructors. These can, in turn, assemble their men for a post mortem on the exercise.
- 37.22 The men should be encouraged to ask questions as to why certain things were or were not done. The leader should then make a detailed statement of instances where his men could have given a better performance. Repetition of the exercise after the discussion will usually prove of great value in correcting errors and increasing efficiency.

## APPENDIX A

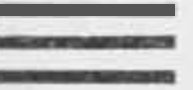
### Organisation of the Rescue Section

*Note.*—The appointment of Head of the Rescue Section is not included since, in common with other Sections of the Corps, this appointment is normally filled by an officer of the Corps authority who is not a member of the Corps.

Appointment	Marking	In charge of	Composition	
			Men	Vehicles
Chief Rescue Officer		The Rescue Section of the local Division of the Corps	—	Staff car
Deputy Chief Rescue Officer				
Column Rescue Officer		Rescue Column comprising 3 companies	513	27 P.C.Vs. 13 staff cars 3 C.E.Vs. 12 motor-cycles
Deputy/Column Rescue Officer (Appointments to be made as and when required at the discretion of the Corps Authority)				
Company Rescue Officer		Rescue Company comprising 3 platoons	169	9 P.C.Vs. 4 Staff cars 1 C.E.V. 3 motor-cycles
Deputy Company Rescue Officer				
Rescue Officer		Rescue platoon comprising 6 parties	54	3 P.C.Vs. 1 Staff car
Deputy Rescue Officer				
Rescue Party Leader		Rescue Party	8	
Deputy Rescue Party Leader				

*Note.*—C.E.Vs., staff cars and motor cycles will not be issued for training purposes.

## APPENDIX B

### I—Rescue Party Equipment

(To be carried by each of five parties in a platoon)

Item	Quantity
<i>Part I (provided centrally)</i>	
Auger, eyed, 1 in. diam. 10 in. overall length .. .. .	8
Axe, fireman's, ash handle .. .. .	8
Bands, webbing, casualty (sets of 4) .. .. .	4
Bar steel, 3 ft. straight with chisel end .. .. .	2
Bar, wrecking, 18 in. .. .. .	8
Blanket .. .. .	8
Bond, wire, 15 ft. length (scaffold lashing) .. .. .	8
Bottle, water .. .. .	8
Chisel, brick, 12 in. .. .. .	8
Cord, sash, 15 ft. length .. .. .	8
Dressings, mine, medium .. .. .	32
Gloves, debris, (pair) .. .. .	8
Goggles, dust, (pair) .. .. .	8
Hammer, club, 2½ lbs. .. .. .	8
Hammer, sledge, 7 lbs. .. .. .	1
Kitbag .. .. .	8
Knife, clasp, with marline spike .. .. .	8
Ladder, extending, short .. .. .	1
Lanyard for clasp knife .. .. .	8
Pliers, side cutting, insulated .. .. .	8
Pouch, first-aid, with contents .. .. .	8
Rope, manilla, 1½ in. × 40 ft. length .. .. .	8
Saw, general purpose, with additional blade .. .. .	8
Shovel, handled, G.S. pattern .. .. .	2
Tool, entrenching .. .. .	8
Torch, electric, 2 cell, rubber-sheathed .. .. .	8
Webbing equipment, manpack Mk. II (set) .. .. .	8
<i>Part II (provided locally)</i>	
<i>(Grant-aided at the rate of 75%)</i>	
Battery, dry 1.5 volt for torch .. .. .	16
Dressings, adhesive, (tin) .. .. .	8
Salts, smelling, 1 oz. bottle .. .. .	8



APPENDIX B (continued)

II—Rescue Platoon Equipment

(To be carried by the sixth party of a platoon)

Item	Quantity
<i>Part I (provided centrally)</i>	
Axe, fireman's ash handle .. .. .	8
Block, snatch, lightweight .. .. .	2
Bond, wire, 15 ft. length (scaffold lashing) .. .. .	12
Chisel, brick, 18 in. .. .. .	2
Chisel, plugging, 12 in. .. .. .	2
Cord, sash, 15 ft. length .. .. .	8
Cropper, bolt, $\frac{1}{2}$ in. $\times$ 18 in. .. .. .	2
Dressings, mine, medium .. .. .	32
Equipment, hauling and lifting .. .. .	1
Gloves, debris (pair) .. .. .	10
Gloves, insulation (pair) .. .. .	2
Goggles, dust (pair) .. .. .	8
Groundsheet .. .. .	8
Kit, hydraulic rescue .. .. .	1
Kitbag .. .. .	8
Knife, clasp, with marline spike .. .. .	8
Lanyard for clasp knife .. .. .	8
Rope, manilla, 2 in. $\times$ 100 ft. length .. .. .	2
Screwdriver, 12 in. .. .. .	2
Torch, electric, 2 cell, rubber-sheathed .. .. .	8
Webbing, equipment, manpack Mk. 1 (complete) .. .. .	8
Wrench, pipe, 14 in. Stillson type .. .. .	2
<i>Part II (provided locally)</i>	
(a) (Grant-aided at the rate of 75%)	
Battery, dry 1.5 volt for torch .. .. .	16
Dressings, adhesive, first-aid (tin) .. .. .	8
Nails, mixed, bag 4 lbs. .. .. .	2
(b) (Grant-aided at the rate of 100%)	
Plywood, 13 in. square (used with groundsheet) .. .. .	8
Plywood, 13 in. $\times$ 5 in. .. .. .	8

APPENDIX B (continued)

III—Rescue Company Equipment

(To be held in reserve to be brought forward as necessary in C.E.Vs.)

Item	Quantity
<i>Part I (provided centrally)</i>	
*Bag, tool, carpenter's .. .. .	36(3)
Blade, saw, general purpose .. .. .	36
*Blade, saw, bushmans, 30 in. .. .. .	12(2)
*Blanket, asbestos .. .. .	12(2)
Block snatch, lightweight .. .. .	2
Bond, wire 15 ft. length (scaffold lashing) .. .. .	72
*Bottle, oxygen .. .. .	24(4)
*Bottle, propane .. .. .	12(2)
*Bucket, 2 gallon .. .. .	9(3)
*Chain, 6 ft. 15 cwt. lift .. .. .	6(2)
Chisel, brick 12 in. .. .. .	24
Chisel, brick 18 in. .. .. .	24
Chisel, plugging 12 in. .. .. .	24
Cord, sash 15 ft. length .. .. .	144
Cropper, bolt, ¼ in. × 18 in. .. .. .	3
*Crowbar, 5 ft. mushroom and point .. .. .	3(1)
*Crowbar, 5 ft. 6 in. chisel and claw .. .. .	3(1)
*Outfit, portable, flame, cutting .. .. .	6(1)
Equipment, hauling and lifting .. .. .	3
*Floodlight, paraffin .. .. .	36(4)
Gloves, debris (pair) .. .. .	144
Gloves, insulation (pair) .. .. .	12
Goggles, dust (pair) .. .. .	72
*Goggles, tinted, welders (pair) .. .. .	48(8)
Groundsheet .. .. .	24
Handle, (spare) for hauling and lifting gear .. .. .	6
Handle, (spare) for entrenching tool .. .. .	24
Kit, hydraulic rescue .. .. .	3
*Lamp, electric, stadium type .. .. .	72(8)
Pliers, side cutting, insulated .. .. .	12
*Pump, stirrup .. .. .	3(1)
Rope, manilla, 2 in. × 100 ft. length .. .. .	6
Rope, manilla, 1½ in. × 40 ft. length .. .. .	24
*Rope, wire, ½ in. × 50 ft. length .. .. .	12(3)
Rope, wire (spare) for hauling and lifting gear .. .. .	6
*Satchel for blanket asbestos .. .. .	12(2)
*Saw, bushmans, 30 in. complete .. .. .	3(1)
Saw, general purpose, complete .. .. .	12
Shovel, handled, G.S. pattern. .. .. .	24

Note: Only items marked \* will be provided for training in quantities as indicated in brackets

APPENDIX B (continued)

III—Rescue Company Equipment (continued)

(To be held in reserve to be brought forward as necessary in C.E.V.s.)

Item	Quantity
*Sling, wire, $\frac{3}{8}$ in. $\times$ 10 ft. length .. .. .	12(2)
*Tarpaulin, 10 ft. $\times$ 10 ft. .. .. .	12(1)
Torch, electric, 2 cell, rubber-sheathed .. .. .	24
*Stand (floodlamp, paraffin), long .. .. .	3(2)
*Stand (floodlamp, paraffin), short .. .. .	3(2)
Webbing equipment, manpack Mk. I (set) .. .. .	18
Wrench, pipe, 14 in. Stillson type .. .. .	3
<i>Part II (provided locally)</i>	
(a) (Grant-aided at the rate of 75%)	
Battery, dry 1.5 volt for torch .. .. .	288
*Battery, dry, 6 volt for electric lamp, stadium type .. .. .	144(8)
Bulbs, 2.5 volt for torch .. .. .	144
Bulbs, 6 volt for electric lamp, stadium type .. .. .	72
Dressings, adhesive (tin) .. .. .	144
Nails, mixed, bag (14 lb.—4 in.: 14 lb.—6 in.) .. .. .	1
*Mantles for floodlight .. .. .	72(8)
(b) (Grant-aided at the rate of 100%)	
*Can, paraffin, 2 gallon .. .. .	18(1)

Note: Only items marked \* will be provided for training in quantities as indicated in brackets

## APPENDIX C

### Personal, Party and Platoon Manpack Rescue Equipment Details of Assembly, Stowage and Carriage

#### *Types*

- 1 The present pattern of the personal webbing equipment is adapted from the standard Service type. It consists of belt, braces and pouch.
- 2 The Manpack Mark II has been designed to be capable of being opened out for easy checking, removal and replacement of any item of equipment, without the whole of the pack having to be unloaded. During operations it can be lifted and carried without having to be completely re-fastened, the carrying handles being designed for this purpose. All items of equipment are now completely enclosed.

#### *Assembly and fitting*

##### *Belt*

- 3 The belt consists of three parts: back, right and left sides. The bottom edge of the belt has eyelets, and the inside of the belt has slots at  $\frac{1}{4}$  inch intervals. To fit the belt together, place the back part on top of the right and left sides (slots uppermost) and engage the hooks on the sides in the convenient slots on the back. Then fit to the waist, adjusting hooks into fresh slots as necessary. The fireman's axe pouch should be fitted to the back part of the belt before final assembly.

##### *Braces*

- 4 These are worn on the right and left part of the belt and carry fittings to receive the shoulder straps for the pack. Wearing the belt, position braces on its outside and mark the positions. Remove the belt and engage the four hooks of each brace in belt slots.

##### *Carrier*

- 5 The carrier is worn on the left hip. Engage the hooks of the carrier in the belt eyelets at the left hip.

##### *Pouch*

- 6 The pouch is worn on the right hip. Pass the belt through the loops of the pouch, one loop on the back part, one on the right side: re-connect right side of belt to back part.

##### *Pack*

- 7 To fit the pack adopt the following sequence:  
Slacken the buckles of both shoulder straps.  
Put the shoulder straps over the shoulders and engage them in the braces.  
Fasten the stub straps of the pack to the buckles on the shoulder straps.  
Fasten the buckles of the pack straps to the under arm part of the shoulder straps.  
Pass the two pack straps through the loops on the bottom of the packs, cross them over the front (i.e. the exposed portion of the pack when worn) of the pack and fasten them to the small buckles near the stub straps.

8 The personal manpack equipment is now fully assembled and ready to wear.

### Packing packs

9 The instructor should provide each member of his party with an empty pack and the necessary pack articles laid out beside it. The instructor, similarly equipped, faces his party, and demonstrates the sequence in which articles are put into the pack and where stowed therein. The rescue party then practises, supervised by the instructor. In the case of new recruits opportunity will be taken to explain the nomenclature and purpose of each article.

### *Attachment of packs to the individual*

10 The rescue party works in pairs in the following sequence:

'Wearer' puts on his pack engaging the shoulder straps in the braces; let the pack hang unsupported from below thus putting tension on braces and shoulder straps.

Mark the shoulder straps at the wearer's shoulders and then remove the pack. Take shoulder strap buckles off pack stub straps.

With pack fitted and worn, fasten the first aid pouch to it. The pouch should hang snug under the pack with its sling over the top of the pack.

### Party equipment

11 When party manpacks are fully loaded and worn, the items carried by hand are picked up by the appropriate party numbers and the party is ready to go into action.



Fig. 145. The proposed Mark II manpack (left) and the existing Mark I type (right)

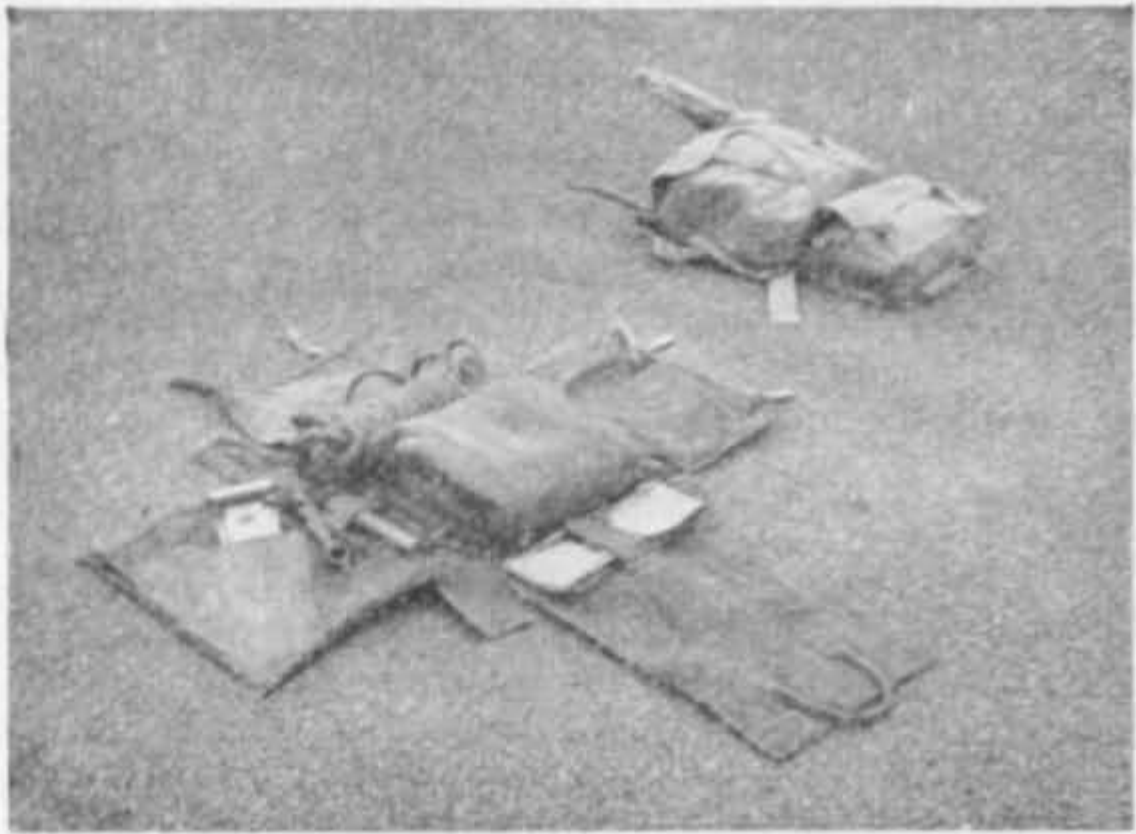

Fig. 146. Proposed Manpack Mark II, opened showing layout of equipment.  
Compare with Mark I pack alongside



Fig. 147. Mark II manpack showing method of carrying by strap

## APPENDIX C

### Carriage of Rescue Party Manpack Equipment

On the belt		In the pack		In the hand			
lbs.	ozs.	lbs.	ozs.	Carried by	lbs.		
Axe, fireman's	2	4—in pouch on right side	Auger, eyed, 1 in.	—	11	Carried by	
Cord, personal, 15 ins.		9—hanked and suspended from press stud webbing loop on right side.	Bands, webbing (1 long, 1 short)	1	10	Party leader	Nil
Dressings, adhesive (tin)		5 } —in carrier on left hip	Bar, wrecking	3	12	No. 1 (Deputy party leader)	Bottom half section of short extension ladder
„ „ mine (4)			Blanket	4	2		18
Goggles, dust (pair)			†Chisel, 8 in, cold			14	No. 2
Torch, electric, 2 cell	1	0 }	Entrenching tool and handle	2	0	No. 3	Hammer 7 lb. sledge
Gloves, debris (pair)		7—in map pocket of BD trousers or denims	Hammer, club, 2½ lb.	2	12	No. 4	Shovel, G.S. pattern
Knife, clasp, with lanyard		5—in left breast pocket of BD blouse or denims, lanyard round left shoulder.	Lashings 40 ft.	2	9	No. 5	Shovel G.S. pattern
			Pliers, side-cutting		11	No. 6	Bar, steel, 3 ft. straight with chisel end
			Saw, general purpose with additional blade		14	No. 7	Bar, steel, 3 ft. straight with chisel end
Total	5 lbs. 3½ ozs.		Total	20	14		6
			<i>Slung over Pack</i>				6
			First-aid pouch	1	12		56½
			*containing:				
			Bandages, triangular (4)				
			Bottle water, filled				
			Dressings, mine, (4 large)				
			„ „ (4 small)	4	4		
			Labels, casualty (1 pkt)				
			Pins, safety (2 cards)				
			Scissors with lanyard				
			Tourniquet, cane				
			Salts, smelling		1		
			Total	6	1		
				26	15		

†To be replaced by chisel, brick, 12 ins.

\*The contents of the first aid pouch are under review.

## APPENDIX C (continued)

### Carriage of platoon rescue equipment

- 12 The equipment is divided into 8 packs (the standard pack as now on issue), with a piece of thin plywood, 13 in. square, inserted as a protection for the wearer's back (see also note below), and another piece 13 in. × 5 in. inserted at the bottom of the pack in order to prevent undue wear, viz:

Pack No.	Contents
1	Hydraulic rescue kit pump—2 lengths of hose—ram—adapter for ram—wedge spreader—base plate—ram toe—plunger toe—groundsheet.
2	Hydraulic rescue kit pump—2 lengths of hose—ram—adaptor for ram—alligator spreader—base plate—ram toe—plunger toe—groundsheet.
3	Hauling and lifting machine—groundsheet.
4	Steel wire rope and reel—handle—groundsheet.
5	Snatch block—100 ft. 2 in. rope—groundsheet.
6	Snatch block—100 ft. 2 in. rope—groundsheet.
7	Pipe wrench Stillson 14 in.—18 in. brick chisel—screwdriver over 9 in.—12 in. plugging chisel—18 in. × $\frac{1}{2}$ in. bolt cropper—pair debris gloves—bag of nails—6 wire bonds—pair insulated gloves—groundsheet.
8	Pipe wrench Stillson 14 in.—18 in. brick chisel—screwdriver over 9 in.—12 in. plugging chisel—18 in. × $\frac{1}{2}$ in. bolt cropper—pair debris gloves—bag of nails—6 wire bonds—pair insulated gloves—groundsheet.

*Note:* (a) In each case the groundsheet is folded flat round the 13 in. square of plywood.

(b) The packs should be numbered 1-8.

#### *Method of stowage*

- 13 Stowage of the above articles does not lend itself to a specific drill. The general principle should be to stow the bulkier articles first and then pack the lighter ones in around them.



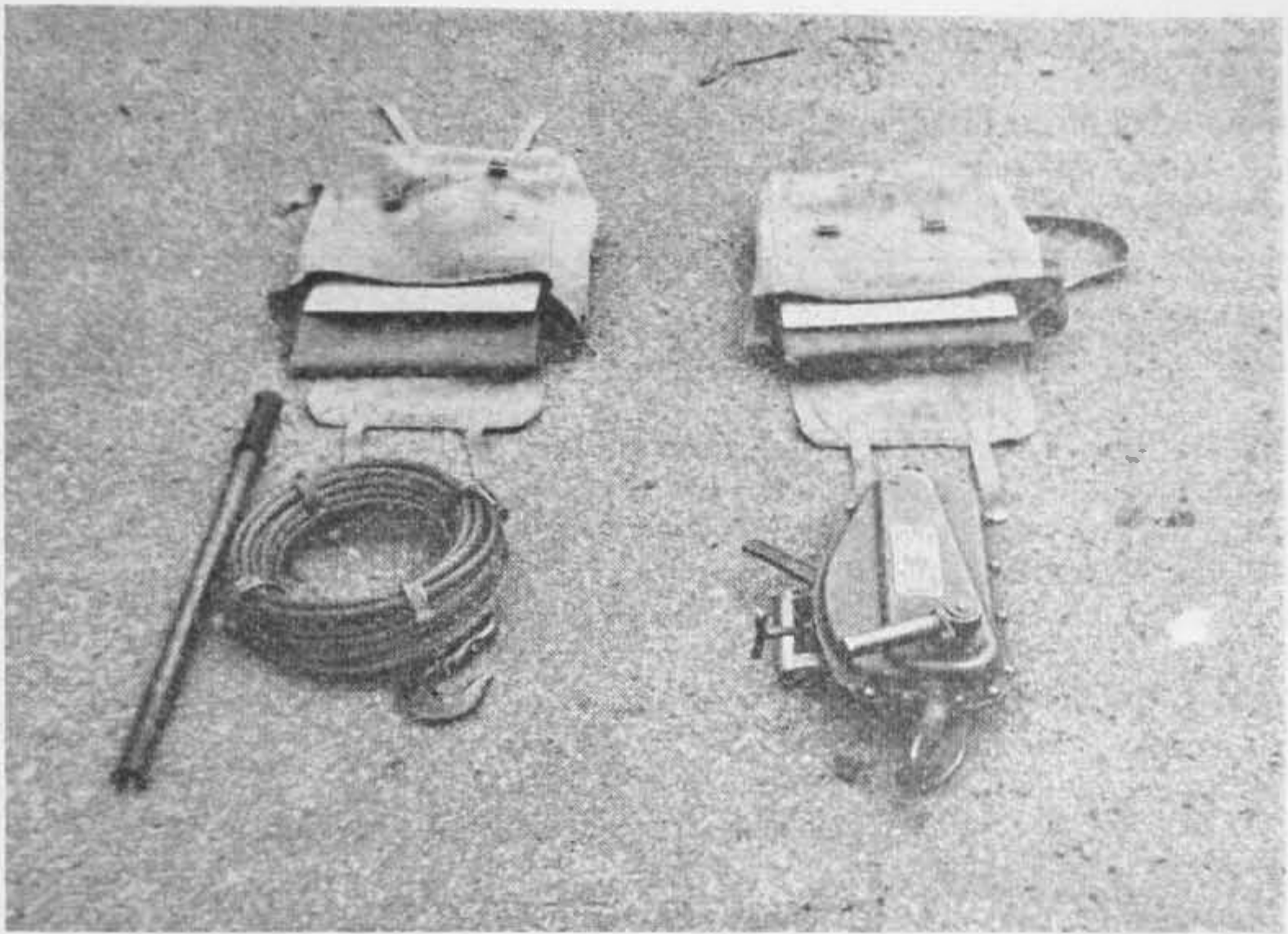

Fig. 148. An example of Packs No. 4 and 3

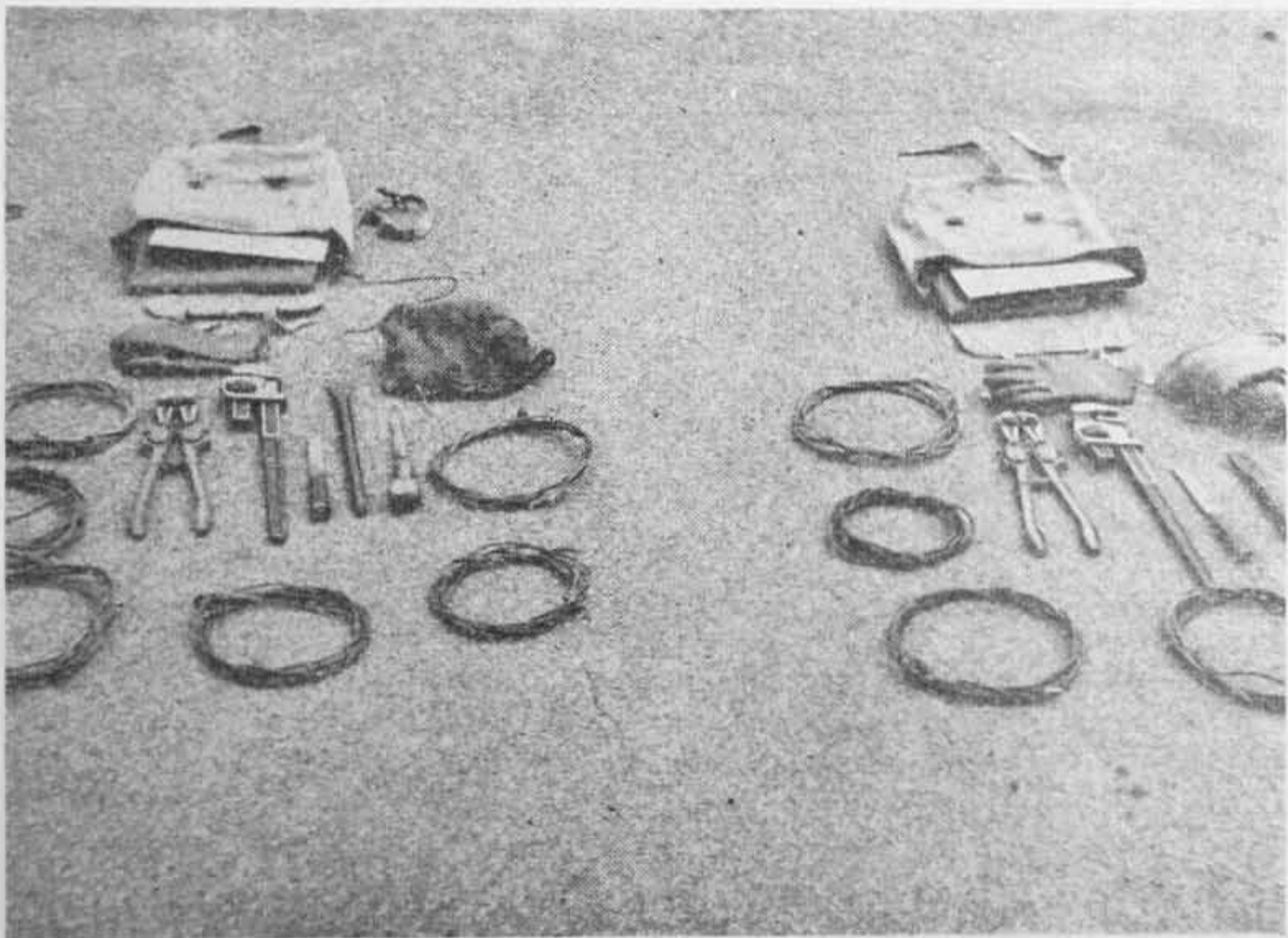

Fig. 149. An example of Packs No. 7 and 8

**APPENDIX C (continued)**

**14** In the event of the lifting and hauling machine and the hydraulic power equipment not being available in sufficient quantities, one party in each platoon will be supplied with minipacks as follows:

Pack No.	Contents
1	screw jack (5 ton) and handle. 1 sling 10 ft. $\times$ $\frac{3}{8}$ in. steel wire rope (S.W.R.) ground sheet.
2	ratchet jack (5 ton) ground sheet.
3	2 slings 10 ft. $\times$ $\frac{3}{8}$ in. S.W.R. ground sheet jack handle (can be carried by hand)
4	pul-lift ground sheet
5 } 6 }	As above
7 } 8 }	As above

## APPENDIX D

### Territorial Army Units which will be mainly responsible for the Rescue and Casualty Evacuation Role

- 1 As a result of the disbandment of the Mobile Defence Corps, the Royal Artillery and Infantry Units of the Territorial Army are being trained to carry out the immediate rescue tasks in support of the Civil Defence authorities previously allotted to MDC Battalions. Whilst the role of TA Brigades in the event of nuclear attack will remain that of general support and all its units must be prepared to carry out any tasks which they may be asked to do, a proportion will, in the event, undoubtedly be issued with the necessary appropriate special equipment, made mobile and be called upon for immediate rescue tasks.
- 2 The units concerned are of the following types:

#### Royal Artillery

##### *Field Regiment*

##### (a) *Organisation*

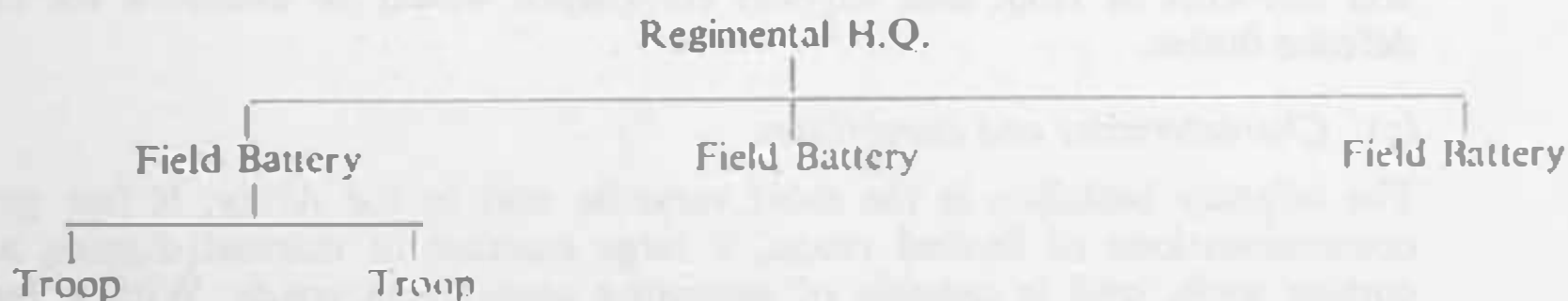

##### (b) *Personnel and transport*

Out of a strength of about 600 all ranks (140 each battery) a field regiment might provide approximately 500 for general C.D. duties. The regiment has nearly thirty cargo vehicles (3 and 5 tons) and twenty-five landrover type trucks.

##### (c) *Characteristics and capabilities*

The regiment has excellent wireless and line communications and is fully mobile in its own vehicles. Batteries are administratively self-contained. It is therefore well fitted for such tasks as reconnaissance, liaison, control of traffic or homeless, etc., as well as more general duties.

##### (d) *Rescue potential*

When used in the rescue role the regiment may be assumed to be able to find approximately the equivalent of 48 \*rescue sections (approximately 16 per battery).

*Medium Regiment*

*Light Regiment*

{ From the civil defence point of view their organization and characteristics may be considered as similar to those of a Field Regiment.

## Infantry

### Infantry Battalion

#### (a) Organisation

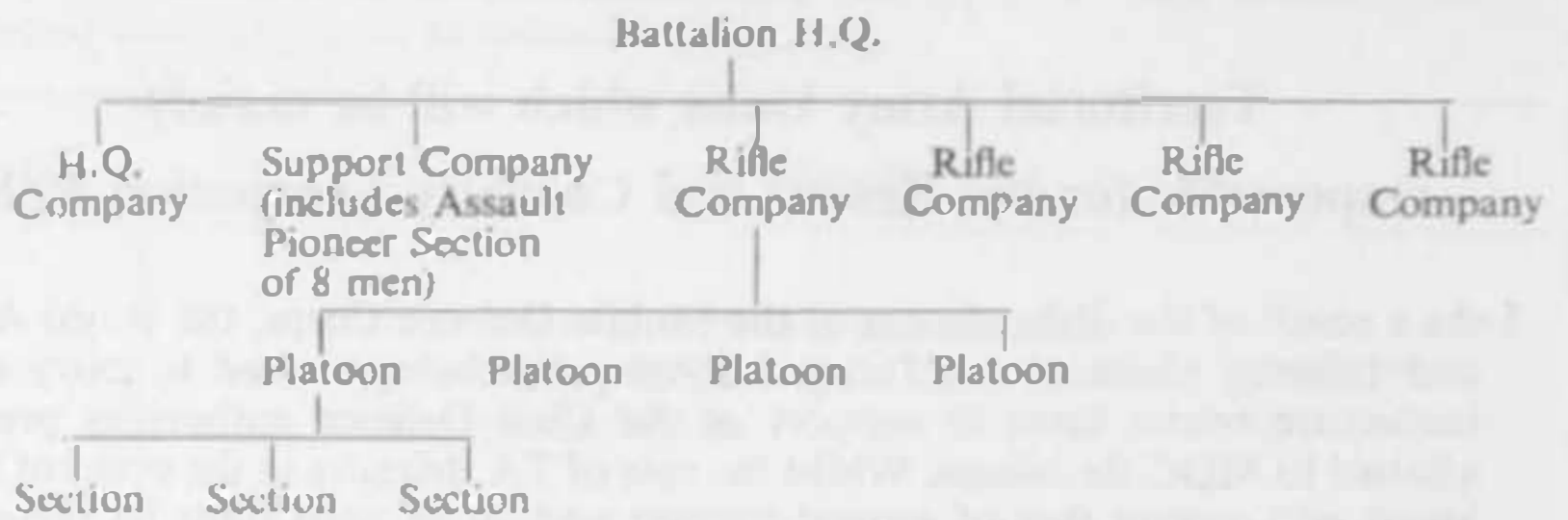

\* A "rescue section" of the Armed Forces is the equivalent of a rescue party of the Civil Defence Corps.

#### (b) Personnel and transport

The strength of a battalion will vary according to the length of time since mobilization.

At full strength a battalion is about 940 all ranks and a regular battalion has about 40 Landrovers and 1-ton vehicles and about 20 × 3-ton vehicles.

A T.A. battalion has considerably less vehicles, and many will be requisitioned civilian ones.

A rifle company at full strength is about 140 all ranks. All the rifle companies and elements of H.Q. and support companies would be available for civil defence duties.

#### (c) Characteristics and capabilities

The infantry battalion is the most versatile unit in the Army. It has good communications of limited range, a large number of manual digging and cutting tools, and is capable of operating away from roads. With a large number of junior leaders and a high proportion of available manpower, all with some training in light rescue and first aid, it is capable of carrying out a variety of civil defence tasks, including assistance to the police, light rescue, stretcher bearing, debris clearance, and limited reconnaissance for radioactivity.

#### (d) Rescue potential

When used in the rescue role a battalion may be assumed to be able to find approximately the equivalent of 48 rescue sections (9 from each Rifle Company and 12 from the Support Company).

## Royal Army Medical Corps

### Field Ambulance

#### (a) Present organisation

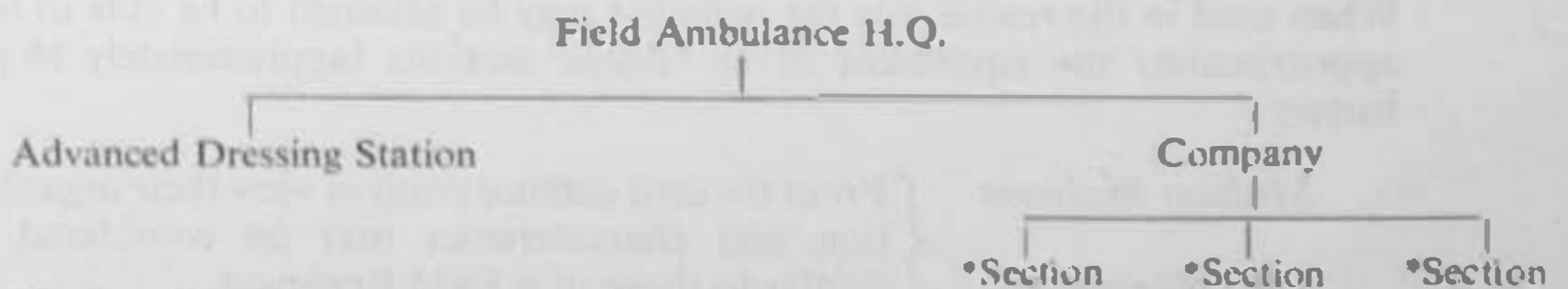

\*Each section can form a Casualty Clearing Post.

(b) *Personnel and transport*

The unit has a strength of approximately 225 all ranks, of which about 130 are trained medical personnel (doctors and nursing orderlies). The officers include eight doctors and a dental surgeon. The vehicles include eight four-stretcher ambulances and eight landrover type trucks equipped with stretchers.

(c) *Characteristics and tasks*

The field ambulance is a mobile, self-sufficient unit designed for immediate first aid, sorting and clearance of casualties. In civil defence operations it could provide forward decontamination and sorting of the injured and emergency treatment before despatch to hospital, the treatment of light injuries before discharge to welfare care and the holding of those serious cases which would not benefit from hospital treatment (although it is not normally a holding unit). A field ambulance could deal with some 6,000 casualties a day and is at present being reorganized to give it both a holding and collecting potential. It should be noted that the unit has very few ambulance cars for the evacuation role and it will therefore rely on the support of civilian ambulance convoys and must be supported to the maximum extent by RASC transport of the load carrying kind.

**Territorial Army rescue equipment**

- 3 The rescue equipment to be carried by Territorial Army units which will be mainly responsible for the reserve role will be of a high scale, similar to that of the former M.D.C. battalion, and will include heavy items such as jacks and floodlights.

## APPENDIX E

### Headings for Briefing Commanders of Supporting Troops

#### I. Situation

- (a) Details of attack:
  - (i) Position of ground zero. Ground or air burst.
  - (ii) Time of attack.
- (b) Effects of attack:
  - (i) Estimated extent and general nature of damage.
  - (ii) General fire situation.
  - (iii) Contamination: fall-out plot as far as known.
  - (iv) Damage to essential services (electricity, gas, telephones, etc.).
  - (v) Any big hazards: chemical, gas, electricity, water, etc.
- (c) Steps to deal with attack:
  - (i) Locations of subordinate controls. Position of mobile controls if deployed.
  - (ii) Forces already deployed or expected.
  - (iii) Road situation. Routes which forces moving in may or may NOT use.
  - (iv) Rendezvous.
  - (v) Routes to reception and hospital areas.
  - (vi) Ambulance check points.
  - (vii) State of signals communications.

#### II. Mission

I would like assistance in the following tasks, in order of priority:

#### III. Factors affecting the mission

- (a) Sub-allocation of forces.
- (b) Forces already working in the area (e.g., fire, rescue, casualty collecting, and, in Scotland, casualty wardens).
- (c) Boundaries of area in which formation/unit has been allotted.
- (d) Degree of local control functioning.
- (e) Rendezvous.

- (f) Vehicle parking sites.
- (g) Radioactivity—dose-rates.
- (h) Fire situation.
- (j) Roads which CAN be used.
- (k) Roads which CANNOT be used.
- (l) Type of property (for rescue parties).
- (m) Approximate number of casualties.
- (n) Ambulance loading points.
- (o) Position of Forward Medical Aid Units.
- (p) Ambulance check points.
- (q) Disposal of dead.
- (r) Hazards—electricity, gas, water.
- (s) Unexploded missiles (if any).
- (t) Location of special high risks (e.g. petrol store).
- (u) Location of special danger points (e.g., bridges and aqueducts).
- (v) Homeless. action to be taken.
- (w) Reliefs.

#### **IV. Administration /Logistics**

- (a) *Civil Defence Forces:*
  - (i) Petrol and oil.
  - (ii) Feeding.
  - (iii) Blankets.
- (b) *All Forces:*
  - (i) Water.
  - (ii) Accommodation.
  - (iii) Tools.
  - (iv) Transport.

#### **V. Command and signal**

- (a) Present, future positions. Higher controls.
- (b) Where reports are to be sent and when.
- (c) Any changes in communications available.

*Any Questions?*

## APPENDIX F

### Briefing of a Rescue Officer at a) Sector b) Post Warden and c) Senior Warden level

*Note:* This example deals with a Rescue Officer (6 rescue parties) reporting to Sector for orders. The Sector Warden decides to send the platoon to one of his Post Wardens who, in turn, sends the platoon to one of his patrol areas.

Main Heading and Sequence	Essential Sub-heading and Sequence	Information given by Sector Warden	Information given by Post Warden	Information given by Senior Warden
Situation .. ..	Extent of area ..	—	—	Outline of boundaries of patrol area.
	Nature of area ..	—	—	Brief description of type of property, e.g., mainly residential brick houses, blocks of concrete built buildings, any factories, etc.
	Nature of attack ..	H.E. or nuclear and, if nuclear, whether air or ground burst, position of G.Z.	—	Distance of area from GZ.
	Time of attack ..	Time of attack	—	—
	Extent and general nature of damage.	—	e.g., any general information available at Warden Post regarding patrol area into which the rescue platoon is about to move and en route thereto.	Brief description of extent and particular nature of damage applicable to whole patrol area.
	Fire situation ..	(Only if the rescue platoon is likely to be affected during onward move to Post Warden)	(Only if the rescue platoon is likely to be affected during onward move to Senior Warden.)	Fire situation throughout area with particular reference to its effect on rescue of casualties, e.g., well under control and no impediment to rescue OR, e.g., under control except for (give localities). Position of Fire Control H.Q.
	Fall-out situation ..	This is a MUST (present or NOT).	This is a MUST (present or NOT).	Radioactivity present or not: dose-rate and whether increasing or decreasing.



**APPENDIX F (continued)**

	Location of subordinate controls.	(Only if the rescue platoon is likely to be affected during onward move to Post Warden.)	(Only if the rescue platoon is likely to be affected during onward move to Senior Warden.)	
	Road situation ..	(Roads usable and non-usable, but only if the rescue platoon is likely to be affected during onward move to Post Warden.)	(Roads usable and non-usable, but only if the rescue parties are likely to be affected during onward move to Senior Warden.)	
	Casualties .. ..	—	—	Details of total numbers of trapped and surface casualties as known or as inferred.
<b>Mission</b> .. ..	Tasks and priorities ..	“Will you please report with your whole platoon to Warden Post 3 Post Warden Green) and subsequently act under his instructions.”	“Will you please report with your rescue parties to Patrol Post 3/A (Senior Warden White) and subsequently act under his instructions.”	“Will you please undertake rescue work in the northern half (describes or shows) of my area with particular reference to the following priority tasks: 1st—that school (points)—many children trapped—threatened by fire. 2nd—the houses on either side of MONTROSE AVENUE (points)—many trapped—risk of flooding in some cases. 3rd—that basement shelter (points)—probably 50 or so uninjured in there—valuable to assist us when released.”
<b>Factors affecting the Mission</b> ..	Forces already working in the area.	—	—	Details of any services (Rescue, Military, etc.) already at work in that area, with location of their H.Q. If no services are in, say so.
	Degree of local control functioning.	—	—	Beats and names of wardens working in the area into which the rescue platoon is to be deployed.
	Restrictions on movement.	—	—	Limitation on vehicle movement, if vehicles present.
	Parking places ..	(If onward movement in vehicles is not possible.)	(If onward movement in vehicles is not possible.)	
	Routes .. ..	Route to Warden Post 3.	Route to Patrol Post 3/A.	Routes to priority tasks pointed out OR, if they cannot be seen, guides detailed.

APPENDIX F—continued.

Main Heading and Sequence	Essential Sub-heading and Sequence	Information given by Sector Warden	Information given by Post Warden	Information given by Senior Warden
	Particular hazards ..	(Only if any on the route to Warden Post 3, e.g. presence of nearby U.X.M.)	(Only if any on the route to Patrol Post 3/A, e.g. live electric cable in near vicinity of road.)	Details regarding flooding, coal gas, B.W., C.W., U.X.Ms., live electric cables, etc., etc., and whereabouts in all cases. If no hazards present, say so.
	Evacuation of casualties.	—	Location of ambulance loading points (A.L.P.) if set up by Post Warden which would happen if it were not possible to get vehicles into patrol areas.	Location of casualty collecting points (C.C.P.), ambulance loading points (A.L.P.), and designation and name of person in charge, e.g. first aid party leader Brown or warden Blue.
	Location of special high risks.	—	—	Location of petrol stores, gunsmiths' shops (gunpowder), etc., etc.
Administration/ Logistics.	Homeless .. ..	—	—	Action to be taken in regard to homeless.
	Supplies .. ..	—	—	Any instructions regarding reliefs, feeding of personnel, equipment dumps, water, etc.
	Equipment .. ..	—	—	
	Reliefs .. ..	—	—	
Command and Signal	Reporting .. ..	—	—	Any abnormal instructions regarding reporting arrangements for periodic personal contact between Senior Warden and Rescue Officer.
Questions .. ..	—	By the Rescue Officer.	By the Rescue Officer.	By the Rescue Officer.

Points to note

- 1 The above is ONE EXAMPLE only; others, e.g., division of the rescue platoon at Warden Post level among two or more Patrol Areas can be made useful exercises for training in briefing.
- 2 No more information is given at Sector or Warden Post level than is necessary to get the rescue platoon to Warden Post and Patrol Post, respectively.
- 3 Information already given, or which might be expected to have been given, at a higher level of control, is not repeated at a lower level. If it has not been given at the higher level, then the Rescue Officer can ask for it at the lower level.
- 4 The Rescue Officer can, after he has seen the tasks, change the priorities given if technical reasons so justify, but if he does so he must inform the Senior Warden.

WHENEVER POSSIBLE GIVE YOUR ORDERS FROM WHERE YOU CAN SEE THE GROUND

**Example of Consequential Orders by the Rescue Officer to his Platoon**

		On Leaving Sector Warden	On Leaving Post Warden	On Leaving Senior Warden
<b>Situation</b> .. ..	Nature of attack and time	A ground burst nuclear attack took place about 8 miles from here 5 hours ago.	Light to moderate damage general throughout post area but may be severe where we are going.	See Appendix G.
	Radioactivity .. ..	Nil so far.	Radioactivity nil so far.	
<b>Mission</b> .. ..	Task .. .. .	We are to report at Warden Post No. 3.	We are to report at Patrol Post No. 3/A.	
<b>Factors</b> .. ..	Method of Movement	Rejoin your vehicles and I will lead the way; vehicles at 20 yards interval: speed 20 m.p.h.	I understand road to P.P. 3/A should be all right with careful driving: rejoin vehicles and follow me: vehicles at 10 yards interval: speed 15 m.p.h.	
	Further orders ..	On reaching W.P. 3 vehicles close up nose to tail, deputy officer only dismount and follow me for briefing.	On reaching P.P. 3/A vehicles close up nose to tail: all dismount and get ready to move on foot: my deputy to join me for briefing.	

## APPENDIX G

### An Example of Verbal Orders by a Rescue Officer i/c a Rescue Platoon on leaving the Senior Warden (vide Appendix F)

In this example the Rescue Officer has just been briefed by the Senior Warden. The Rescue Officer's deputy attended the briefing. The Rescue Officer now calls forward all his party leaders. It is daylight and a fair part of the area can be seen.

#### **Situation**

##### *Fall-out*

- 1 Fall-out is now present, the reading being 1.7 r.p.h. and rising.

##### *Nature of buildings and damage*

- 2 In the area in which we are to work damage is moderate to severe: property is mainly residential, brick built, but there are one or two small concrete built factories.

##### *Fire*

- 3 The fire situation is generally under control except in the BANKS WAY area (points).

##### *Other hazards*

- 4 Except for a risk of flooding in basements of buildings adjoining the canal (points), and a live electric cable across the road near that lorry (points), no other hazards have so far come to light.

##### *Other services in the area*

- 5 Except for the A.F.S. and one first aid party there are no other services yet present.

##### *Casualties*

- 6 Warden's estimate of casualties is some 175 trapped and 200 surface casualties.

##### *Requirement*

- 7 We are required to carry out rescue in the area enclosed by BATH ROAD (points to or describes location)—SEWAGE FARM (points)—line of that CANAL (points)—that WOOD (points).

#### **Mission**

- 8 (a) *Deputy*—You heard the Senior Warden's briefing. Take parties 1, 2 and 3 and work within the area of that WOOD (points)—BANKS WAY—BATH ROAD. Within that area your priority is that SCHOOL (points) where there are many children trapped and operations threatened by fire. Warden Squash is on duty in that area. MOVE off at once. (Footnote 1).  
(b) *Party Leader 4*. Your responsibility is the property on either side of MONTROSE AVENUE (points) from that block of flats (points) to where MONTROSE AVENUE joins BATH ROAD near that telephone kiosk (points). Within that area your priorities are those houses (points) where there is a risk of basements flooding from the canal. Warden Lemon is on duty in that area.

- (c) *Party Leader 5*—Your responsibility is the area from that block of flats (points) to the SEWAGE FARM and along the line of the canal. Within that area your priority is that large shelter in which there are believed to be 50 or more trapped but uninjured. When you get them out, direct them to the Senior Warden for allotment to assist in rescue work. The warden in the area is Warden Orange.
- (d) *Party Leader 6*—Carry on dealing as best you can with casualties in the immediate vicinity of this patrol post until I have decided how to allot the platoon equipment.

**Factors (See Footnote 2)**

*Casualty collecting personnel*

- 9 (a) *Party Leader 4*—2 first aid party members are working in your area and have set up a C.C.P. in that FACTORY (points).
- (b) *Party Leader 5*—1 first aid party member has just started work in your area.

*Casualty evacuation*

- 10 A.L.P.'s have been opened there (points) and where MONTROSE AVENUE meets BATH ROAD near that telephone kiosk (points).

*Vehicles*

- 11 P.C.V.'s to return at once to Sector Warden.

**Administration**

*Reliefs*

- 12 There is no prospect of any relief for at least 12 hours.

*Rations*

- 13 Emergency rations are not to be used until I say so. (See Footnote 3).

**Command**

- 14 My H.Q. and vehicle will remain near this patrol post. I will be coming round in the order BANKS WAY parties, MONTROSE AVENUE party, No. 5 Party.

**Any Questions**

- 15 (Deals with relevant questions) . . . MOVE OFF. (Footnote 4).

*Footnote 1* Reference Mission 8 (a). In view of the fire threat to the school, and as the deputy was present at the Senior Warden's briefing, parties 1, 2 and 3 must be got away as soon as possible. The deputy will brief party leaders 1, 2 and 3 en route.

*Footnote 2* The deputy heard all these factors at the Senior Warden's briefing. There is therefore no need to detain him to hear them all over again.

*Footnote 3* It has been assumed that all services would carry some form of emergency rations on the man.

*Footnote 4* Estimated time for thinking out and delivering of the above order is 5 minutes. Had all leaders accompanied the Rescue Officer to his briefing by the Senior Warden the SITUATION paragraphs might be cut to "You have all heard the situation" so saving perhaps 2 minutes. In this example however the object has been to show the full order. Moreover it will not always be possible, or desirable, for party leaders to accompany the Rescue Officer for briefing, e.g. when the latter comes in in advance of his platoon.

## APPENDIX H

### Suggestions for Training in Briefing

- 1 *Demonstrations staged by trained staff:* e.g. stage Appendices F and G as a demonstration.
- 2 *Exercise (indoor)—written.* The students are required to rearrange the jumbled version under the correct headings and in the correct sequence. The answers are then discussed by the class and the official solution put forward and likewise discussed.
- 3 *Exercise (indoor)—oral.* The official solution is accepted as the correct version and each student, in turn, briefs the class accordingly, each briefing being criticised on its completion by the rest of the class.
- 4 *Exercise (outdoor)—oral and written.* In a suitable locality, the instructor describes a picture of damage, casualties, hazards, services available etc. etc. This picture need not be in the correct sequence. Each student takes notes and from his own notes prepares his own verbal order. Each student in turn then briefs the rest of the class using his own brief. Criticism is offered at the end of each briefing.
- 5 *Exercise—indoor or outdoor.* Students are given various appointments in turn, e.g. Warden, Rescue Officer, Ambulance Officer, etc. The instructor acting as, e.g. Sector Warden, briefs the warden as, e.g. Post Warden who in turn briefs officers of services available as per Appendices F and G. (This can be carried on down the chain, e.g. in party leader training, where officers brief their subordinate leaders and they, in turn, their men, thus carrying the briefing right down to actual tasks).
- 6 *Combined exercises—indoor and outdoor.* Officers of ALL sections are got together. An official narrative is prepared by the instructor who, acting as the overall controller, briefs his immediate subordinate; this is then carried on right down the chain bringing in the various services at the appropriate junctures.
- 7 *Variations.* There are many variations of the above which will occur to imaginative officers and instructors. The climax of this training should of course be in combined exercises on the ground with services at full strength and fully equipped.

## APPENDIX J

### Refresher Exercises

The following hints may be useful when setting refresher exercises for rescue parties working under trained party leaders.

**1 Casualty handling; problems involving:**

Choice of a method.

Use of webbing bands in dealing with casualty in damaged building or in awkward situation.

Handling casualties in difficult situations.

Handling stretchers up, down and over debris.

**2 Appreciation of damage:**

Points to look for when making reconnaissance of building.

How collapse has taken place and inference on position of casualties.

Care in entering damaged building.

**3 Use of manpack tools:**

Problems which can be dealt with by small tools carried in manpack.

**4 Party equipment carried by hand:**

Problems involving use of these items e.g. crowbars, etc.

**5 Improvisation:**

Problems set so that party have to improvise with timber, etc., found on site.

**6 Debris clearance:**

Problems involving organising and carrying out selected debris clearance to obtain access to a casualty.

**7 Platoon equipment:**

Problems set to ensure that hydraulic power equipment and hauling and lifting machine from platoon equipment are used.

**8 Rescue operations in a damaged area:**

Approach

Co-operation with control

Deployment of men.

**9 Use of short ladders:**

Problems calling for use in rescue above and below ground level.

Problems in which ladders could be used to bridge gaps, areas, etc.

**10 Steel wire ropes and chains:**

Problems involving the linking, shortening etc., of steel wire rope e.g. in hauling.

**11 Sheer legs:**

In moving something which was obstructing access to casualty.

**12 Linking of voids:**

Care in working on debris crawlway.

Deployment and re-deployment of men to avoid fatigue. Problem in basement rescue.

**13 Flame cutting:**

Problem set up to illustrate when flame cutting might be necessary.

Trained man to set up apparatus while instructor explains precautions taken, advantages of flame cutting in certain circumstances, precautions in packing to prevent collapse, use of stirrup pump to damp down, removal of all materials likely to catch fire. Use of asbestos blanket etc.

**14 Floodlighting:**

Lighting the lamp. Choice of stand for lamp according to conditions. Correct setting of lamp to obtain best light for job.



## APPENDIX K

### Estimating Loads

1 For rescue purposes it is seldom necessary to make more than a very rough estimate of the weight of any load. In this connection the following approximations are useful:

9-in. brickwork, per square foot	84 lb.
13½-in. brickwork, per square foot	126 lb.
Concrete and masonry, per cubic foot	120/160 lb.
Breeze partitions, 3 ft. × 3 ft. × 3 in.	152 lb.
Breeze partitions, 3 ft. × 3 ft. × 4 in.	216 lb.
Floors, 2 in. × 4 in., timber joist and flooring, per square foot	6/10 lb.
Floors, 2 in. × 7 in. or 2 in. × 9 in. timber joists and flooring per square foot	10/18 lb.

These approximate weights are for dry materials and allowance must be made for an increase in weight, approximately 20 per cent, when some of these materials are wet.

2 Approximate weights of 10 foot lengths of steel sections, joists and channels with average thickness web, and flanges, are:

10 in. × 6 in.	Rolled steel joists	400 lb.
9 in. × 4 in.	" " "	210 lb.
7 in. × 3½ in.	" " "	150 lb.
6 in. × 3 in.	" " channel	125 lb.
7 in. × 3 in.	" " "	140 lb.
8 in. × 3 in.	" " "	160 lb.
2 in. × 2 in. × ¼ in.	" " angle	30 lb.
3 in. × 3 in. × ⅜ in.	" " "	70 lb.
Steel roof trusses, 20 ft. span (average)		250 lb.
" " "	30 ft. " "	600 lb.
" " "	40 ft. " "	1,200 lb.
" " "	60 ft. " "	2,400 lb.
Timber trusses	20 ft. span (average)	350 lb.
" "	30 ft. " "	800 lb.
" "	40 ft. " "	1,500 lb.
" "	60 ft. " "	3,500 lb.

## APPENDIX L

### The Pul-Lift

- 1 In an emergency it might be necessary to utilise the pul-lift which was a standard item of rescue equipment prior to the introduction of the new hauling and lifting equipment (see Chapter 24). While it cannot be adapted to as many varied tasks as the newer equipment, it can nevertheless play an important part in association with derricks and sheer legs, or on its own, with fibre or steel ropes.
- 2 The pul-lift works on the ratchet principle and has a chain 6 feet long. It is equally convenient for use in hauling or lifting, and its small size, small weight and simple working makes it a popular tackle for short hauls or lifts. One hook is "fixed" to the head of the tackle and another hook "runs" on the end of the chain.
- 3 If the tackle is operated "with load" then, when "hoisting," the pawl rod lever is turned so that the marking "UP" is visible; and, when "lowering", the pawl rod lever is turned so that the marking "DN" (down) is visible. In both cases the lever must be seated in the slot of the handle of the tackle and upward or downward motion is obtained by operating the handle with a pumping action. In either hoisting or lowering, this action should be with the effort applied on the downward movement of the handle and with the upward movement free; if the opposite action



Fig. 150. The Pul-Lift

is obtained, the handle should be turned through 180 degrees around its own pivot, which will permit the reverse movement. In hauling, the effort should be applied when the lever moves towards the operator.

- 4 If the tackle is operated "without load", then the pawl rod lever should be turned to its neutral position. i.e. midway between "UP" and "DN". Turning the side hand wheel will raise or lower the empty hook to the desired position. When pulling on the chain, the two lines of chain should be grasped tightly with one hand and the hand wheel turned with the other hand to free the load brake; the chain should then be pulled in whatever direction is required. The hand wheel should always be used instead of the handle when operating without load.
- 5 Oil holes are provided and it is most important that light machine oil be applied frequently; the ratchets require a heavy grease. The chain should be kept clean and lubricated with machine oil.
- 6 When using the tackle, the running hook should never be jammed up against the head; if this does occur, the lever should be set to "DN" and the handle tapped with a hammer.

© *Crown copyright* 1960

Published by  
**HER MAJESTY'S STATIONERY OFFICE**

To be purchased from  
York House, Kingsway, London w.c.2  
423 Oxford Street, London w.1  
13A Castle Street, Edinburgh 2  
109 St. Mary Street, Cardiff  
39 King Street, Manchester 2  
Tower Lane, Bristol 1  
2 Edmund Street, Birmingham 3  
80 Chichester Street, Belfast 1  
or through any bookseller